



TILLOTSON LTD., CLASH INDUSTRIAL ESTATE,
TRALEE, CO. KERRY, IRELAND

PHONE: +353 66 7121911 FAX: +353 66 7124503

e-mail: sales@tillotson.ie



PARTS LIST

Last updated: May 2001

Illustration of basic parts standard throughout Karting series carburettor.
For individual model listing see following pages.

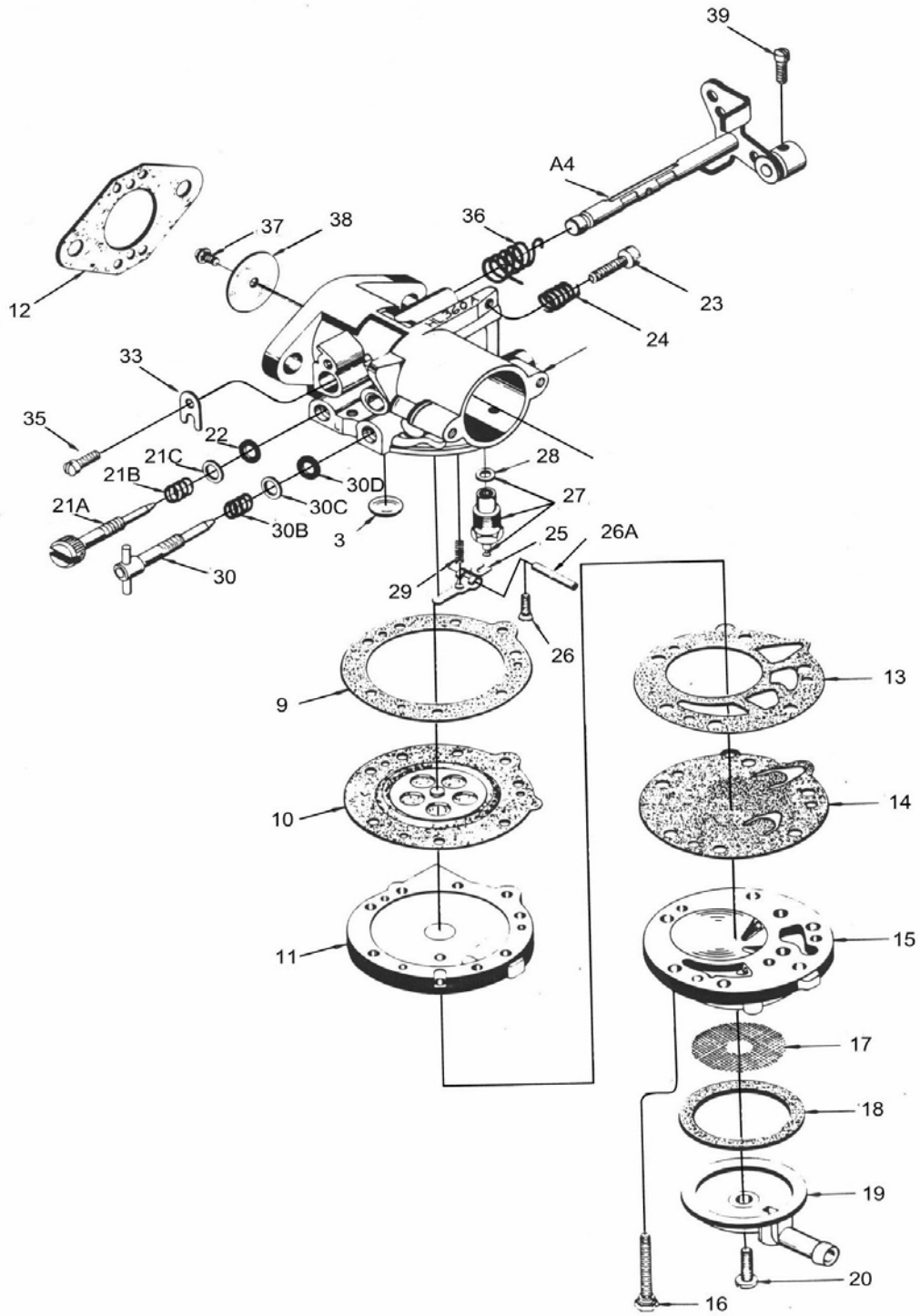

Parts illustrated are typical in appearance
and may not look exactly like the part required



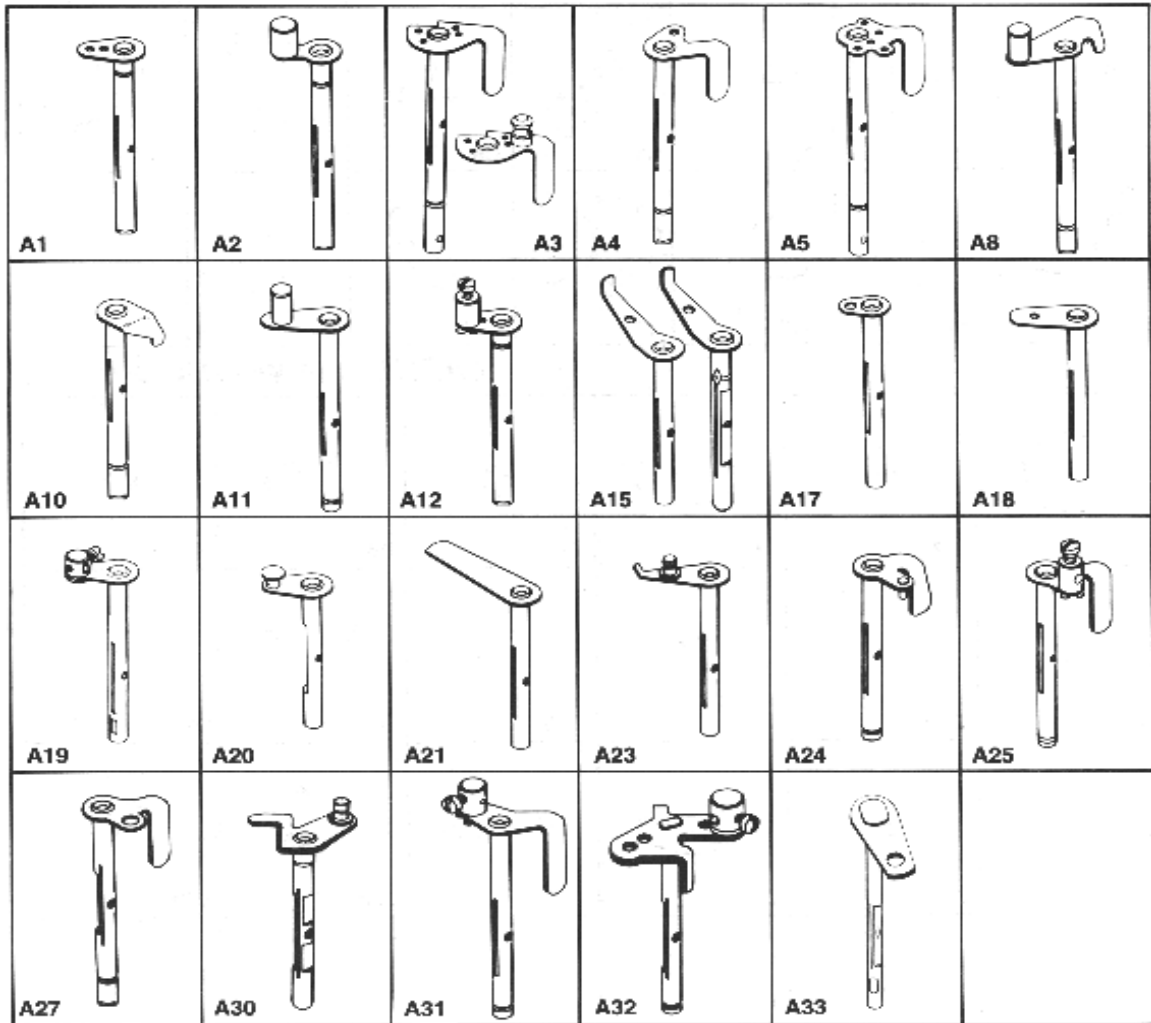



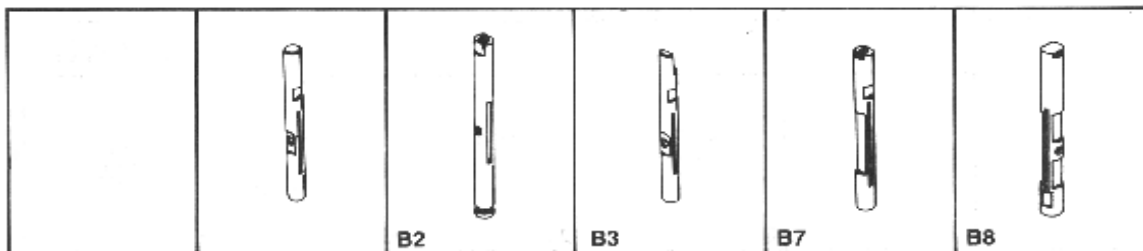





SHAFT & LEVER ASSEMBLIES























SHAFTS







LEVERS

 C1	 C2	 C3	 C5	 C6	 C7	 C8
 C9	 C12	 C13	 C14	 C15	 C16	

MISCELLANEOUS PARTS

 D1	 D2	 D3	 D4	 D6	 D7
 D9	 D10	 D11	 D12	 D13	 D15
 D16	 D17	 D18	 D19	 D20	 D21
 D22	 D23				

SPRINGS

		 E1	 E2	 E4	 E6
--	--	---	---	---	---

Carburetor Model		HL-166B	
Customer		Andreas Stihl	
Equipment Model No.			
Venturi		15.87mm	
Ref. No.	Part Name		
2	Body Channel Cup Plug		
*3	Body Channel Welch Plug	179-55	
4	Choke Friction Pin		
5	Choke Friction Spring		
6	Choke Shutter	27-296	
7	Choke Shutter Screw	15C-29	
8			
+*9	Diaphragm Gasket	16B-217	
+10	Diaphragm	237-600	
11	Diaphragm Cover	91A-250	
*12	Flange Gasket	16B-206	
+*13	Fuel Pump Gasket	16B-223	
+*14	Fuel Pump Diaphragm	237-214	
15	Fuel Pump Body	141-55	
16	Fuel Pump Body Screw (6)	15-C51	
17	Fuel Strainer Screen	95-170	
*18	Fuel Strainer Cover Gasket	16B-205	
19	Fuel Strainer Cover	91A-251	
20	Fuel Strainer Cover Retaining Screw	15B-313	
21	Idle Mixture Screw		
21A	Idle Mixture Screw	43-388	
21B	Idle Mixture Screw Spring	24B-449	
21C	Idle Mixture Screw Washer	78A-256	
21D	Idle Mixture Screw Packing	44-270	
22	Idle Mixture Screw Seal Ring		
23	Idle Speed Screw	15C-9	
24	Idle Speed Screw Spring	24B-131	
*25	Inlet Control Lever	155A-27	
26	Inlet Control Lever Fulcrum Screw	15B-329	
26A	Inlet Control Lever Fulcrum Pin	32-79	
*27	Inlet Needle, Seat & Gasket	233-706	
28	Inlet Seat Gasket	16B-199	
29	Inlet Tension Spring	24B-345	
30	High Speed Mixture Screw		
30A	High Speed Mixture Screw	43-401	
30B	High Speed Mixture Screw Spring	24B-449	
30C	High Speed Mixture Screw Washer	78A-256	
30D	High Speed Mixture Screw Packing	44-270	
31			
32	Throttle Shaft Bushing (2)		
33	Throttle Shaft Clip	29-218	
34	Throttle Shaft Clip Lockwasher		
35	Throttle Shaft Clip Ret. Screw	15C-18	
36	Throttle Shaft Return Spring	24B-291	
37	Throttle Shutter	14A-34	
38	Throttle Shutter Screw	15C-29	
A4	Throttle Shaft & Lever	13-1586	
A15	Choke Shaft & Lever		
D20	Body Channel Screen		
D21	Body Channel Screen Ret. Ring		
D3	Fuel Strainer Element		
B2	Choke Shaft	26-461	
	Repair Parts Kit	RK-114HL	
	Diaphragm & Gasket Set	DG-5HL	

*Indicates contents of Repair Kit

+Indicates contents of Diaphragm & Gasket Set

Carburetor Model		HL-360A	HL-304E	HL-334A
Customer				
Equipment Model No.				
Venturi				
Ref. No.	Part Name			
*3	Body Channel Welch Plug	179-63	179-55	179-55
+9	Diaphragm Gasket	16B-217	16B-217	16B-217
+10	Diaphragm	237-600	237-600	237-600
11	Diaphragm Cover	91A-275	91A-275	91A-275
*12	Flange Gasket	16B-216	16B-216	16B-216
+*13	Fuel Pump Gasket	16B-223	16B-223	16B-223
+*14	Fuel Pump Diaphragm	237-141	237-141	237-141
15	Fuel Pump Body	141-89	141-89	141-89
16	Fuel Pump Body Screw (6)	15C-51	15C-51	15C-51
17	Fuel Strainer Screen	95-170	95-170	95-170
*18	Fuel Strainer Cover Gasket	16B-205	16B-205	16B-205
19	Fuel Strainer Cover	91A-351	91A-251	91A-351
20	Fuel Strainer Cover Retaining Screw	15B-313	15B-313	15B-313
20A	Governor Valve Assembly			
20B	Governor Valve Assembly Gasket			
21	Idle Mixture Screw			
21A	Idle Mixture Screw	43-388	43-388	43-388
21B	Idle Mixture Screw Spring	24B-449	24B-449	24B-449
21C	Idle Mixture Screw Washer	78A-256	78A-256	78A-256
21D	Idle Mixture Screw Packing	44-270	44-270	44-270
22	Idle Mixture Screw Seal Ring			
23	Idle Speed Screw	15C-9	15C-9	15C-9
24	Idle Speed Screw Spring	24B-131	24B-131	24B-131
*25	Inlet Control Lever	155A-27	155A-27	155A-27
26	Inlet Control Lever Fulcrum Screw	15B-329	15B-329	15B-329
26A	Inlet Control Lever Fulcrum Pin	32-79	32-79	32-79
*27	Inlet Needle, Seat & Gasket	233-710	233-710	233-710
*27	Alternative Needle, Seat & Gasket (Nickel Plated Seat)			
28	Inlet Seat Gasket	16B-199	16B-199	16B-199
29	Inlet Tension Spring	24B-299	24B-299	24B-323
29A	Inlet Valve Body			
29B	Inlet Valve Body Screw (6)			
29C	Inlet Valve Diaphragm			
29D	Inlet Valve Gasket			
30	High Speed Mixture Screw			
30A	High Speed Mixture Screw	43-967	43-967	43-967
30B	High Speed Mixture Screw Spring	24B-449	24B-449	24B-449
30C	High Speed Mixture Screw Washer	78A-256	78A-256	78A-256
30D	High Speed Mixture Screw Packing	44-270	44-270	44-270
31A	Nozzle Check Valve		363-503	363-503
32	Throttle Shaft Bushing (2)			
33	Throttle Shaft Clip	29-224	29-224	29-224
34	Throttle Shaft Clip Lockwasher			
35	Throttle Shaft Clip Ret. Screw	15C-19	15-C19	15C-19
36	Throttle Shaft Return Spring	24B-381	24B-381	24B-381
37	Throttle Shutter	14A-2	14-407	14-407
38	Throttle Shutter Screw	15C-20	15C-29	15C-29
	Throttle Wire Ret. Screw			
A4	Throttle Shaft & Lever	13-1894	13-1894	13-1894
D16	Throttle Lever Ret. Lockwasher			
D17	Fuel Strainer Cover Ret. Screw Gasket			
	Repair Parts Kit	RK-117HL	RK-117HL	RK-117HL
	Diaphragm & Gasket Set	DG-1HL	DG-1HL	DG-1HL
	Alternative Repair Parts Kits		RK-102HL 233-665P	RK-102HL 233-665P

*Indicates contents of Repair Kit

+Indicates contents of Diaphragm & Gasket Set