

SPECIAL TOOLS SERVICE AIDS and ACCESSORIES

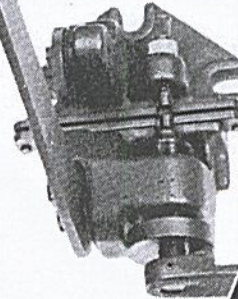
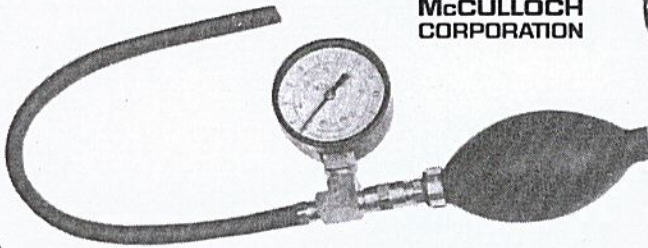
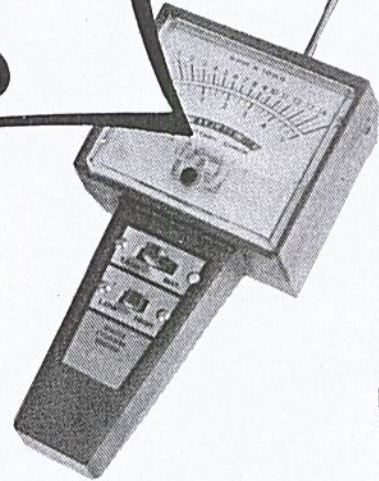

FOR SERVICING
McCULLOCH
POWER TOOLS

•Table of Contents •

SECTION I – SERVICE TOOLS	PAGE 3
SECTION II – SERVICE AIDS	PAGE 7
SECTION III – CHAIN, BAR, ACCESSORIES	PAGE 10

SPECIAL TOOLS

SECTION I - SERVICE TOOLS

PAGE 3



CAP - FUEL
(unvented)

PART NO. 57128

MODELS: 200, 300,
400, 500, 600, 700,
800 Series

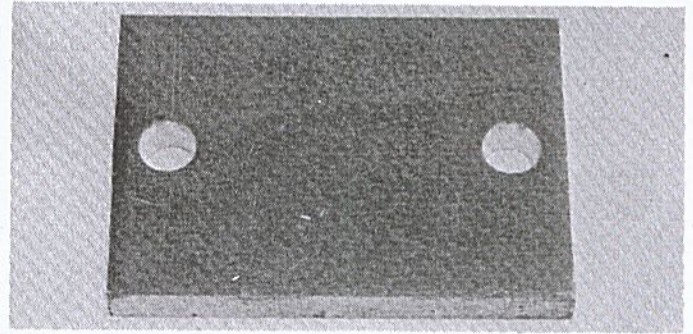

INTAKE ADAPTER

PART NO. 62860

MODELS: 200, 300, 400, 500, 600, 700, 800,
and MC 49

"O" RING - FUEL CAP

PART NO. 101348

MODELS: Used with
57128 Cap

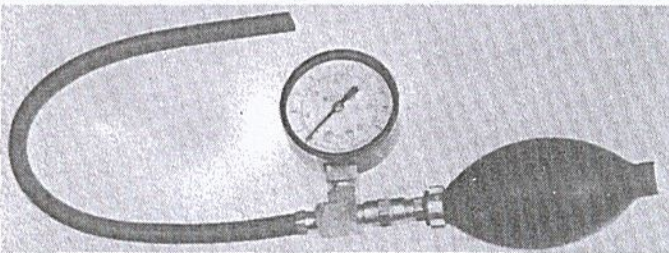
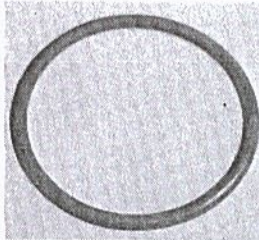

PRESSURE TEST TOOL PART NO. 90533

MODELS: All

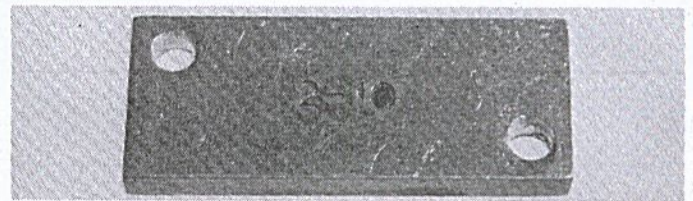

EXHAUST ADAPTER

PART NO. 63137

MODELS: All 10 Series, PM 60

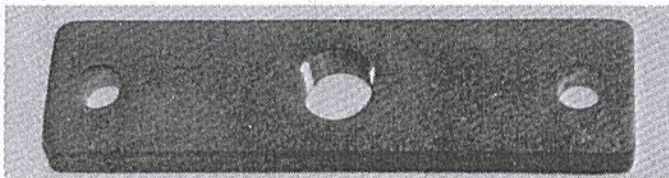

EXHAUST ADAPTER PART NO. 62862

MODELS: 200, 300, 400, 500, 600, 700, 800,
and all Kart Engines

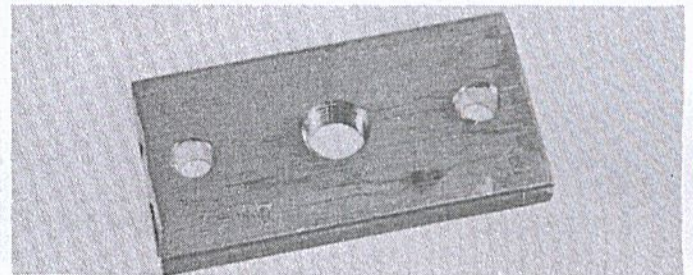

INTAKE ADAPTER

PART NO. 63139

MODELS: MAC 10 Series w/ McC Carburetor

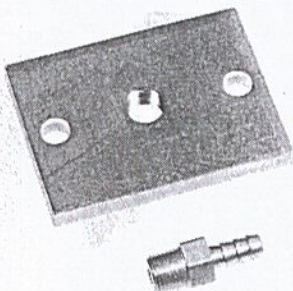

INTAKE ADAPTER

PART NO. 91132

MODELS: 895C, PM 105

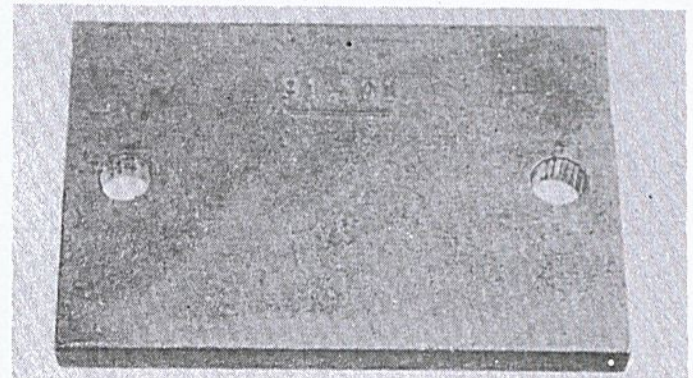

INTAKE ADAPTER

PART NO. 67218

MODELS: MC 91, 91A, 91B, 101, 101A, 101AA

SECTION I - SERVICE TOOLS

SPECIAL TOOLS

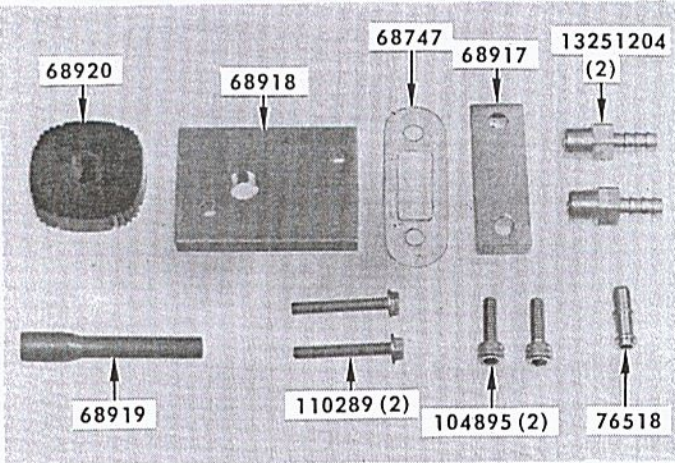

KIT - PRESSURE TESTING PART NO. 68916
 MODELS: PM6A, MM Series

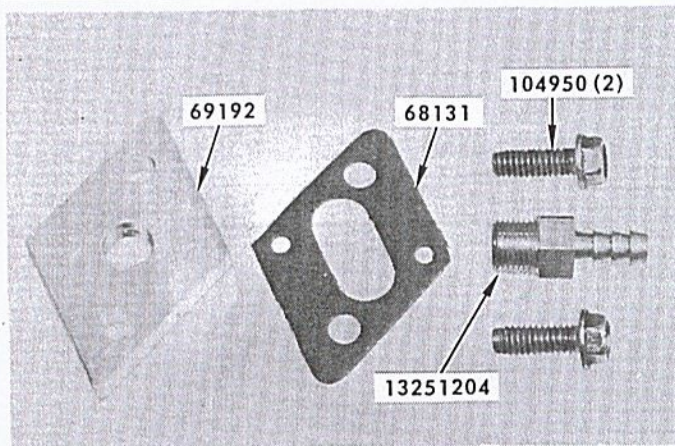

KIT - PRESSURE TESTING PART NO. 69191
 MODELS: MAC 10 Series w/ SDC Carburetor,
 PM 55, PM 60, 7-10A, CP 55, CP 70, SP 60,
 SP 80, SP 81, SP 105, SP 125C

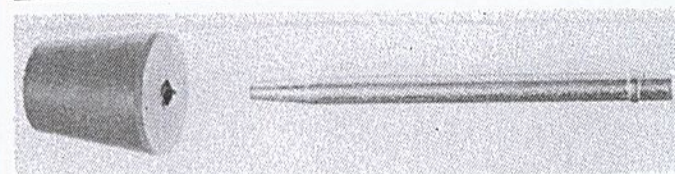

KIT - PRESSURE TESTING PART NO. 85229
 MODELS: MM Series



EXHAUST ADAPTER PART NO. 86177
 MODELS: SP 80, SP 81

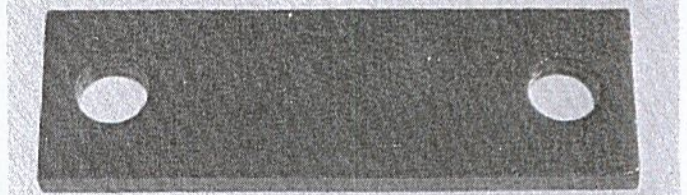

EXHAUST ADAPTER PART NO. 86166
 MODELS: 895C, PM 105, SP 105, SP 125,
 SP 125C

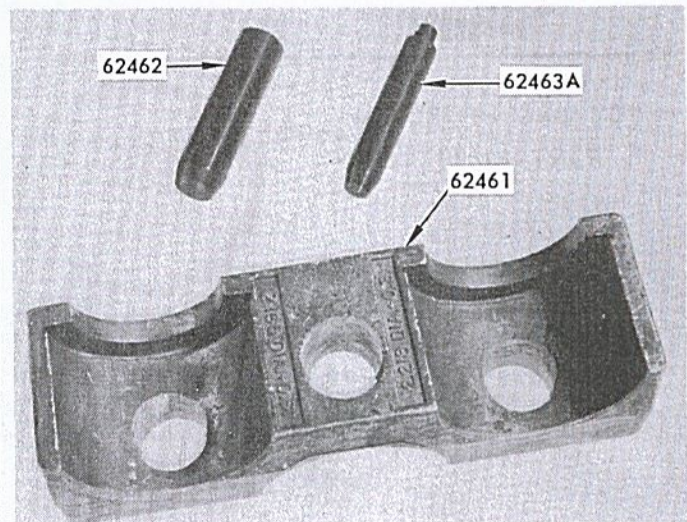

KIT - PISTON TOOL PART NO. 62459A
 MODELS: Use with all McCulloch 2.165, 2.218,
 and 2.125" diameter pistons, including 0.030"
 oversize

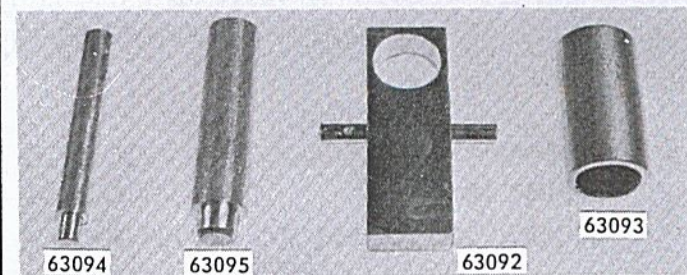

KIT - PISTON TOOL PART NO. 84453
 MODEL: MAC 10 Series (3.3 & 4.3 cu.in.)(full skirt)

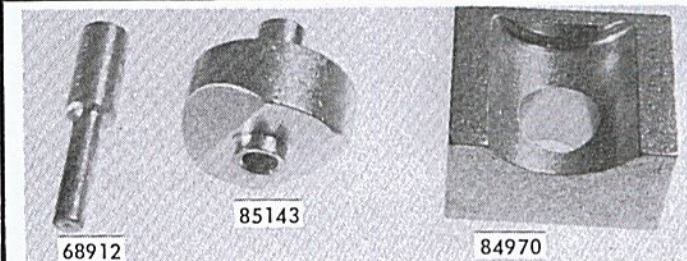

KIT - PISTON TOOL PART NO. 85062
 MODELS: MM Series 1.4 cu. in. only)

SPECIAL TOOLS

SECTION I - SERVICE TOOLS

PAGE 5

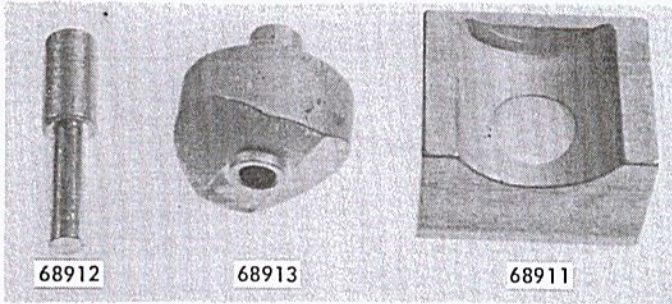

KIT - PISTON TOOL PART NO. 68915
 MODELS: PM6A, MM35 (2.0 cu. in.)

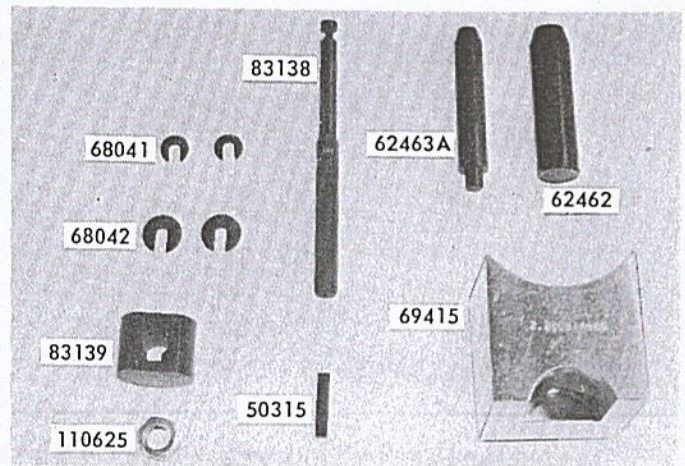

KIT - BLIND PISTON PART NO. 83209
 MODELS: S797, CP 125, CP 125S, MC 101A, MC 101AA
 (SP 105, PM 105, SP 125C, 895C requires Bearing Driver 63095 in Kit 84453)

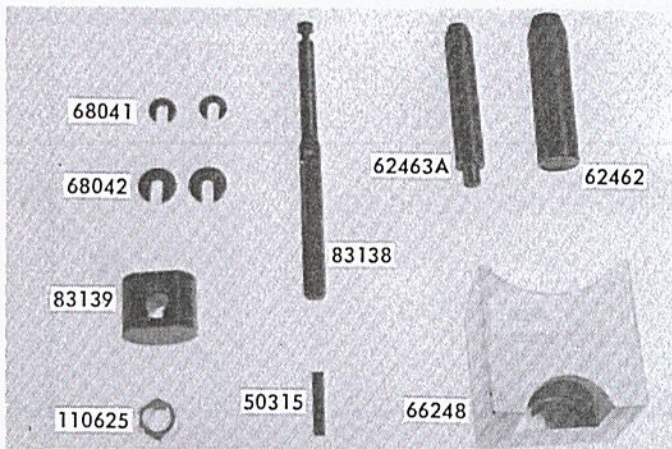

KIT - BLIND PISTON PART NO. 83205
 MODELS: MC91, 91B, 91B1

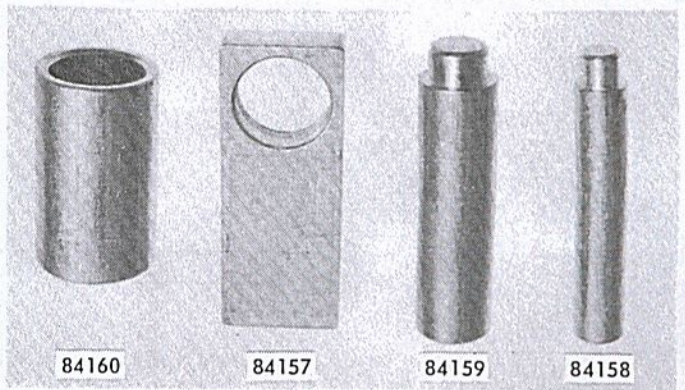

KIT - PISTON TOOL PART NO. 84223
 MODELS: MAC 10 Series (4.3 cu. in.) (slipper skirt), PM60

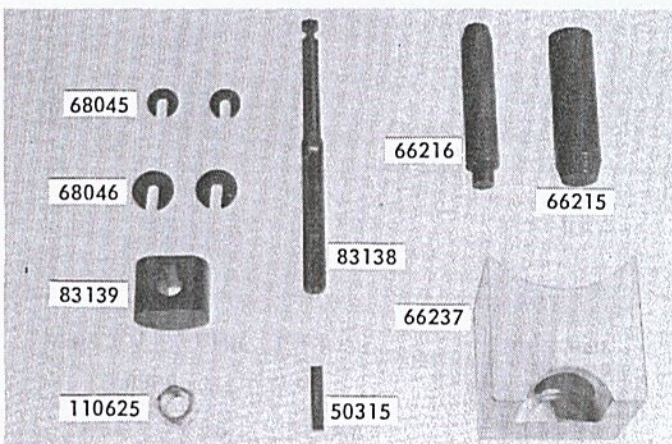

KIT - BLIND PISTON PART NO. 83207
 MODELS: MC 101-101C

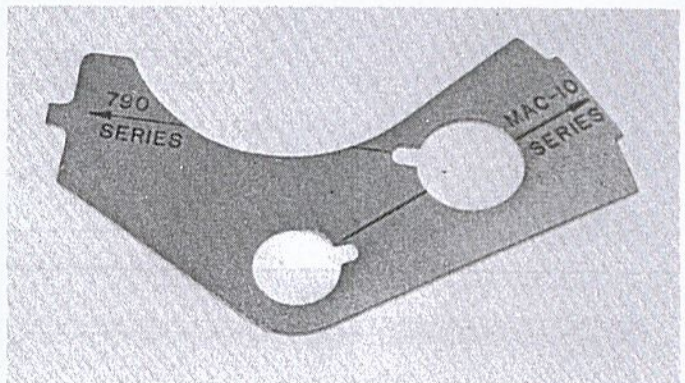

TIMING GUIDE PART NO. 86419
 MODELS: Combination 10 Series, 250, PM60, SP 125 (26° BTDC timing), 790 Series

SECTION I – SERVICE TOOLS

PAGE 6

SPECIAL TOOLS

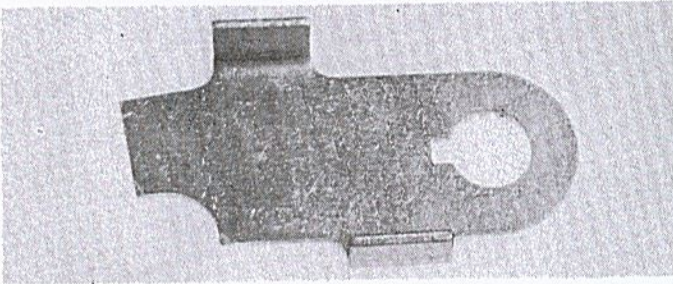

TIMING GUIDE PART NO. 83687
MODELS: PM6A, MM Series (26° BTDC timing)

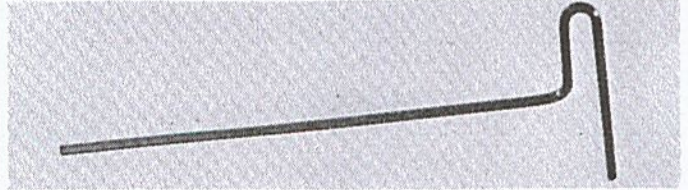

T-HANDLE ALLEN WRENCH PART NO. 59549
(5/32" HEX)

MODELS: 797, CP/SP 125 (muffler screw)

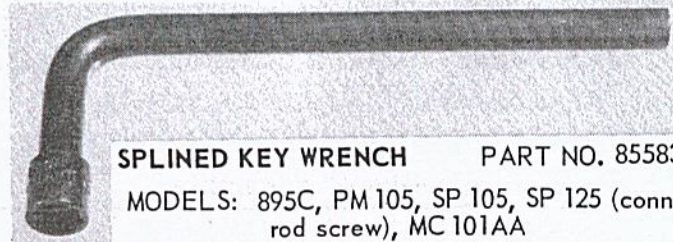

SPLINED KEY WRENCH PART NO. 85583

MODELS: 895C, PM 105, SP 105, SP 125 (conn rod screw), MC 101AA



ALLEN WRENCH – STD PART NO. 101522
(5/32" HEX)

MODELS: 5/32 Allen Screw

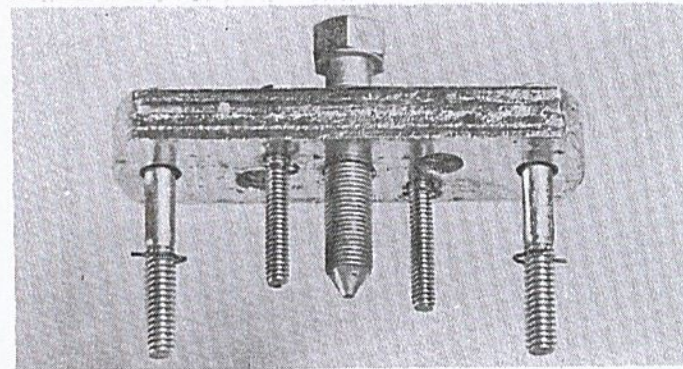

FLYWHEEL & CLUTCH PULLER

PART NO. 51787B

MODELS: All

RIVET INSTALLING TOOL

PART NO. 87884

MODELS: All

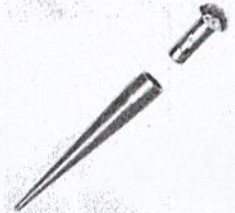

**KIT – SPLIT BEARING
RETAINER** (crankshaft bearings)

PART NO. 68256

MODELS: CP/SP 125, 101A,
101AA

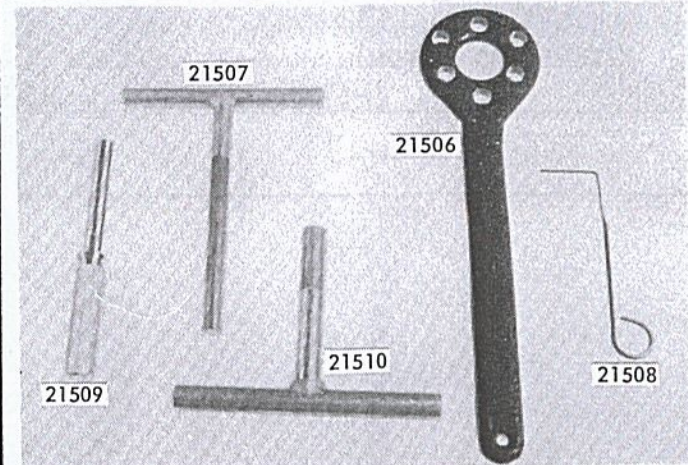

TOOL KIT

PART NO. 21511

MODELS: McCulloch/Mite-E-Lite Generators



REAMER – THROTTLE SHAFT BUSHING

PART NO. 62445

MODELS: McC Carburetors that use
P/N 55062A bushing



SPLINED DRIVER SOCKET

PART NO. 85584

MODELS: 895C, PM 105,
SP 105, SP 125 (conn rod),
MC 101AA

SPECIAL TOOLS

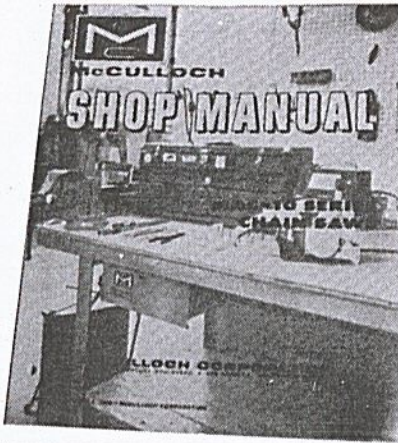

SHOP MANUAL
PART NO. 63084
MODELS:
MAC 10 Series

SHOP MANUAL
(Supplement)

PART NO. 63328
MODELS: 200, 250, 300,
380A, 440, 450, 640
(supplement to shop
manual No. 63829)

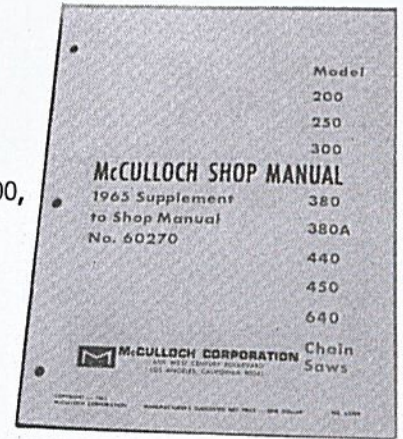

Model	
200	
250	
300	
McCULLOCH SHOP MANUAL	
1965 Supplement	380
to Shop Manual	380A
No. 60270	440
	450
	640
McCULLOCH CORPORATION	Chain
AND WEST CENTURY BOULEVARD	Saws
LOS ANGELES, CALIFORNIA 90048	

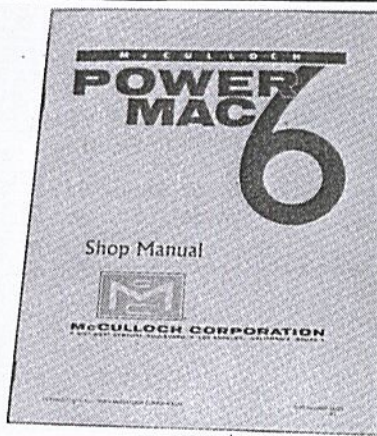

SHOP MANUAL
PART NO. 83323
MODELS: PM6

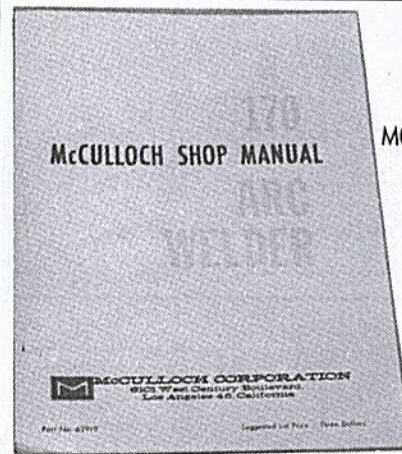

SHOP MANUAL
PART NO. 62919
MODELS: 170 Arc Welder

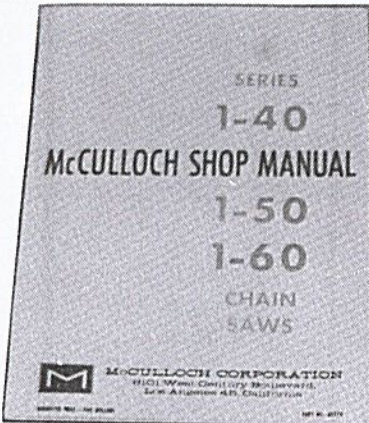

SHOP MANUAL
PART NO. 63829
MODELS: 1-40, 1-50,
1-60 Series

TECHNICAL
LIBRARY

PART NO.
ADV 140000
(Binder only
ADV 130000)

MODELS: All

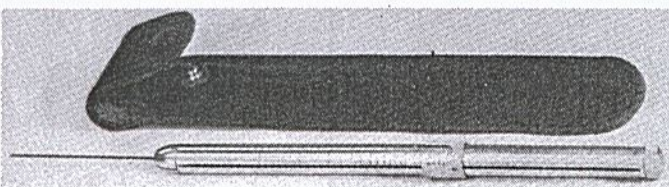

"VIBRA-TAK"

SOURCE: Carver Craft Distributors
1998 Harbor Blvd., Costa Mesa, Ca

USED WITH: All

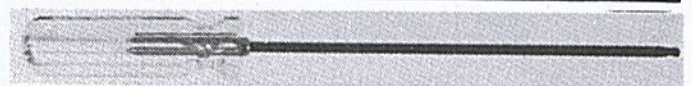

BONDHUS BALL POINT DRIVER

SOURCE: Bondhus Tool Co., Monticello,
Minn. 55362

USED WITH: PM6 (for 9/64" throttle handle
and 5/32" crankcase bottom allen cap screws).
Not recommended for torque loads.

SPECIAL TOOLS

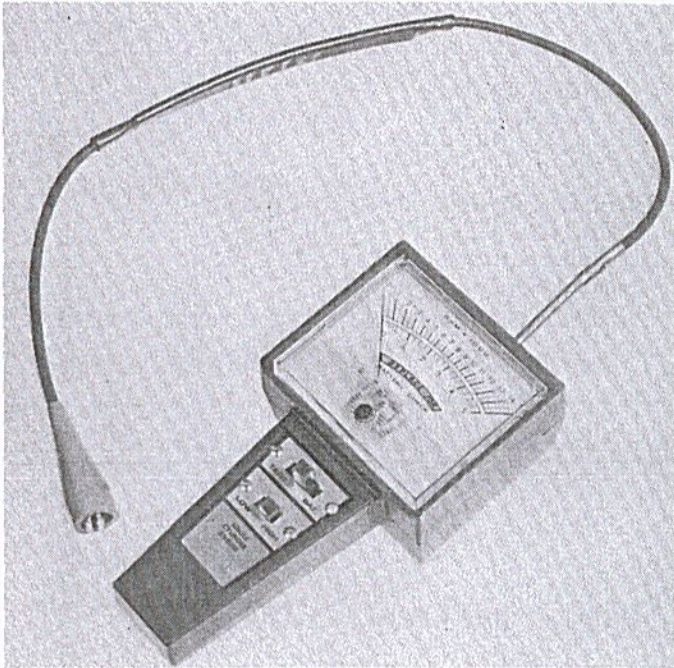

TACHOMETER (2 & 4 cycle, 0–15,000 rpm)
PART NO. 91424 MODELS: All

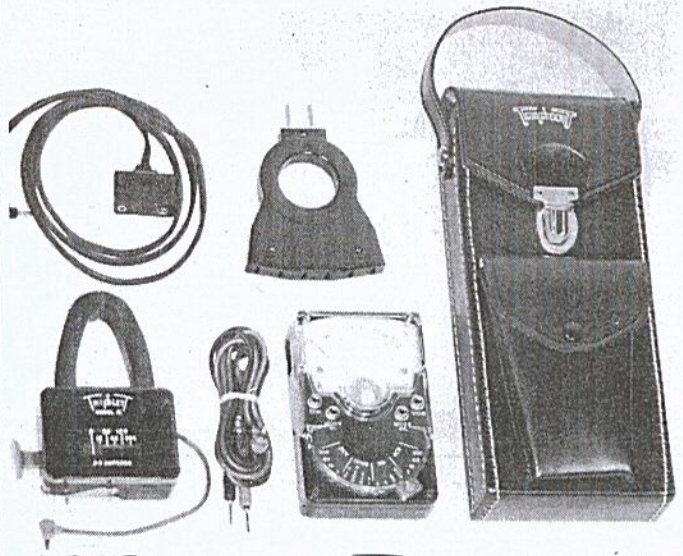

MULTI-PURPOSE VOM METER – MODEL 100
Catalog No. 3014

Includes: Model 310 Multi-purpose V.O.M.;
Model 10 Clamp-On AC Ammeter;
Model 101 Line Separator;
Model 311 42' Leads

SOURCE: Triplet Corporation
286 Harmon Rd., Bluffton, Ohio 45817

USED WITH: 170 Arc Welder

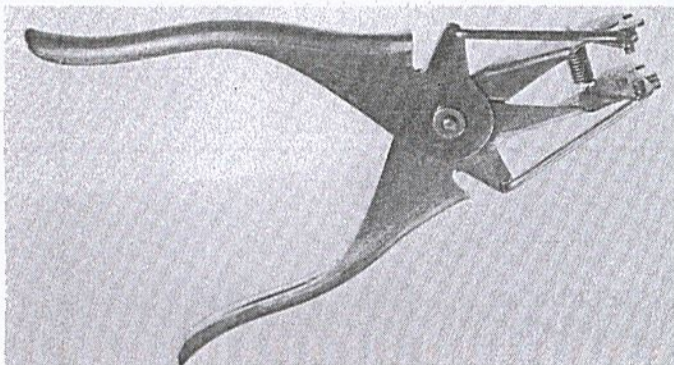

PISTON RING EXPANDER – J-8743

SOURCE: Service Tool Division,
Kent-Moore Corporation
28635 Mound Rd., Warren, Michigan 48092

USED WITH: All



SEALANT PART NO. 110083
MODELS: 10 Series, PM6, MM Series

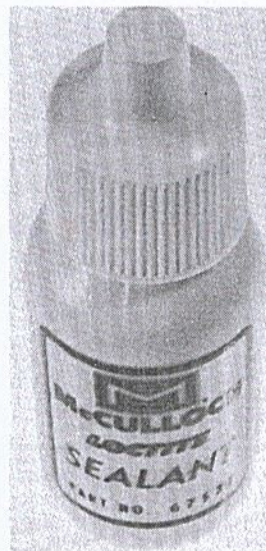

LOCTITE (10 cc)
PART NO. 67537
MODELS: All



LOCQUIC (6 oz.)
PART NO. 69794
MODELS: All

SPECIAL TOOLS

SECTION II - SERVICE AIDS

PAGE 9

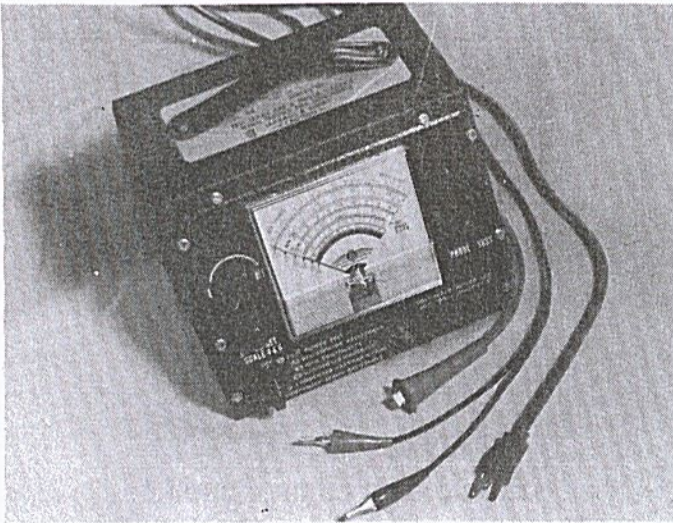

MERC-O-TRONIC IGNITION ANALYZER

SOURCE: Merc-O-Tronic Instrument Corp.
215 Branch St., Almont, Michigan 48003
(carried by some McCulloch distributors)

USED WITH: All



CRAFTSMAN 3/8" DRIVE, 12-POINT, 7/16 x 2-1/2" DEEP BROACHED SOCKET

SOURCE: Sears Roebuck & Company

USED WITH: All units with poppet valve

SPECIAL TOOLS

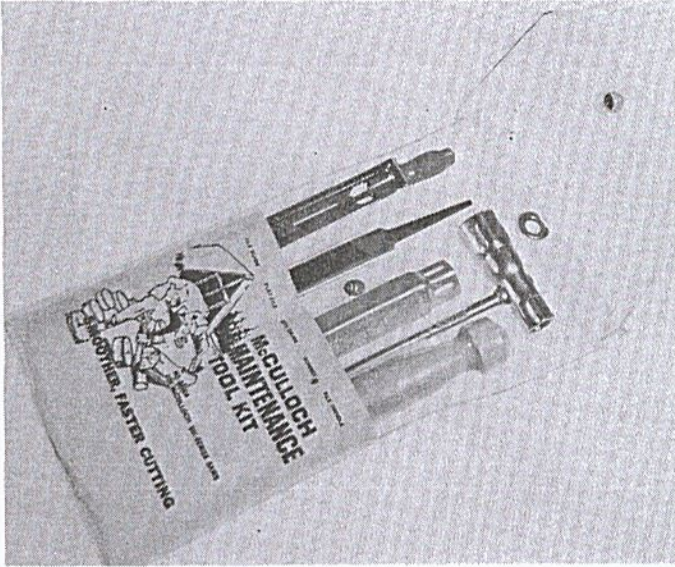

CHAIN MAINTENANCE TOOL KIT

PART NO. 90958

(for PM6 and MM Series)

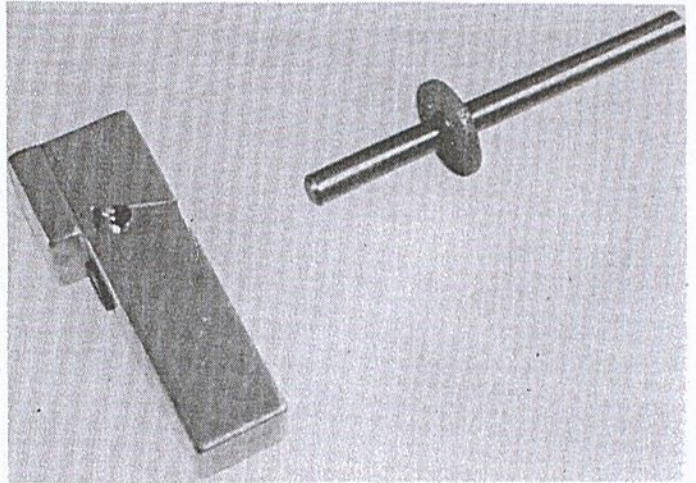

KIT - CARBIDE CHAIN GRINDING

PART NO. 62131

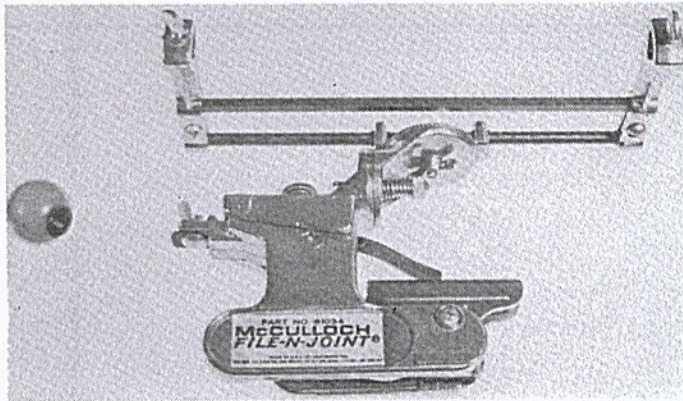

FILE-N-JOINT

PART NO. 61034

(for PROMAC & SPEEDMAC chains, except .250 pitch)

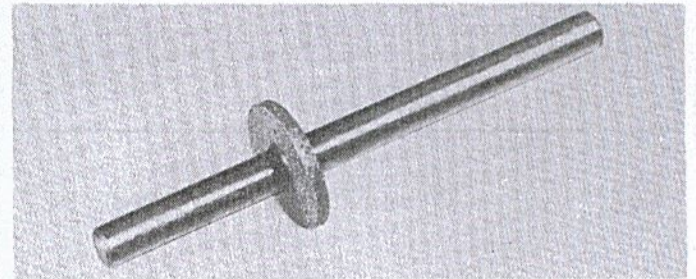

DIAMOND GRINDING WHEEL
(for carbide chain)

PART NO. 62577

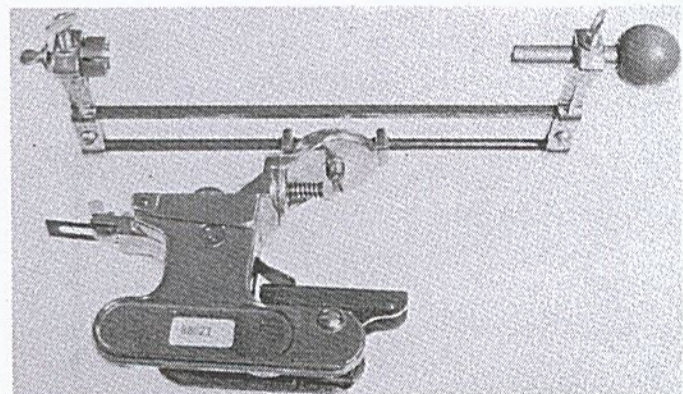

FILE-N-JOINT

PART NO. 88021

(for SUPER PRO chain)

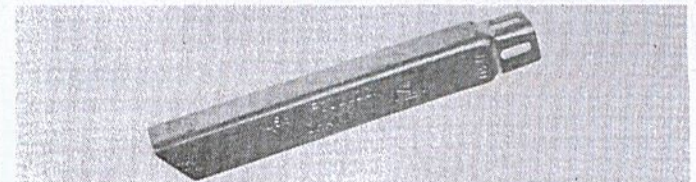

DEPTH GAUGE TOOL

DEPTH	PART NO.
.015-.020"	67688
.025-.030"	67680
.035-.040"	64198
.045-.050"	64359



FILE GUIDE

PART NO. 67750

(Includes 1/8" file)

SPECIAL TOOLS

SECTION III - CHAIN, BAR, ACCESSORIES

PAGE 11

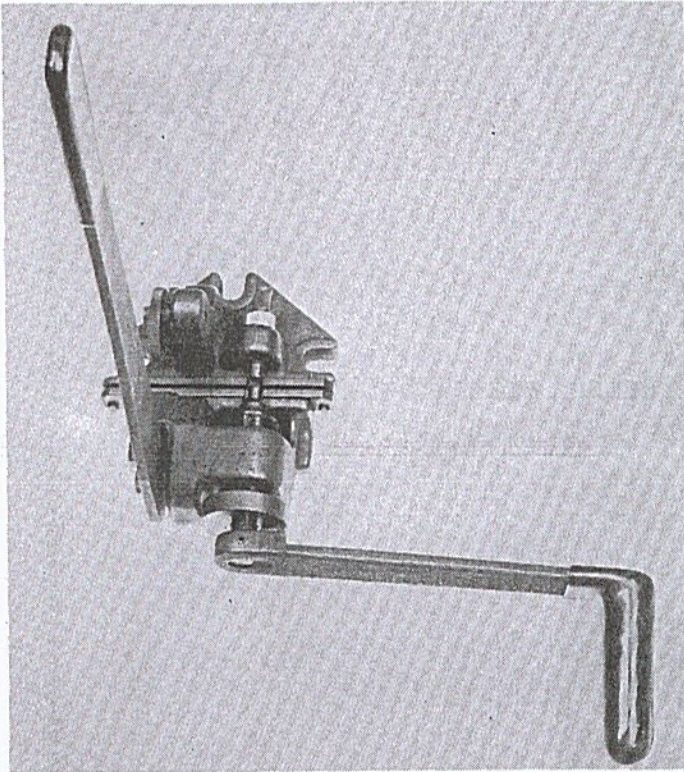

SHOP CHAIN BREAKER/SPINNER
PART NO. 90200

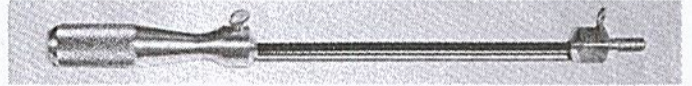

FILE GUIDE PART NO. 60950
(Includes 7/32" file)

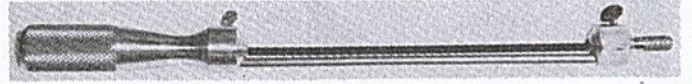

FILE GUIDE PART NO. 86172
(Includes 3/16" file)



FILE GUIDE PART NO. 86826
(Includes 7/32" file)

ALL SPECIAL TOOLS DESCRIBED HEREIN, EXCEPT THOSE
FOR WHICH ANOTHER SOURCE IS INDICATED, ARE
AVAILABLE FROM



McCULLOCH
CORPORATION

5400 ALLA ROAD
P.O. BOX 92180
LOS ANGELES, CALIF. 90009