

Instruction Manual/Owner's Manual

STIHL 031

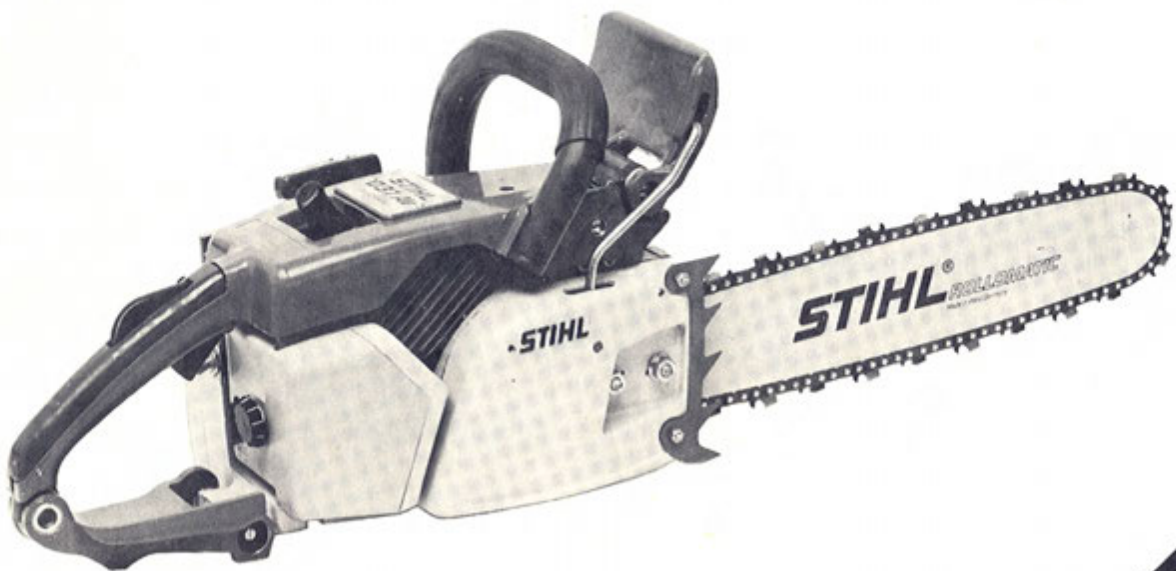

STIHL®

Warning!
For safe operation follow all safety
precautions in owner's manual -
improper use can cause
serious injury!

Important Safety Precautions

1. Do not operate a chain saw when you are fatigued.
2. Use safety footwear, snug-fitting clothing, and eye, hearing and head protection devices.
3. Use caution when handling fuel. Move the chain saw at least 10 feet (3 m) from the fueling point before starting the engine.
4. Do not allow other persons to be near the chain saw when starting or cutting with the chain saw. Keep bystanders and animals out of the work area.
5. Do not start cutting until you have a clear work area, secure footing, and a planned retreat path from the falling tree.
6. Hold the chain saw firmly with both hands, the right hand on the rear handle and the left hand on the front handle, when the engine is running. Use a firm grip with thumbs and fingers encircling the chain saw handles.
7. Keep all parts of your body away from the saw chain when the engine is running.
8. Before you start the engine, make sure the saw chain is not contacting anything.
9. Carry the chain saw with the engine stopped, the guide bar and saw chain to the rear, and the muffler away from your body.
10. Do not operate a chain saw that is damaged, improperly adjusted, or is not completely and securely assembled. Be sure that the saw chain stops moving when the throttle trigger is released.
11. Shut off the engine before setting it down.
12. Use extreme caution when cutting small size brush and saplings because slender material may catch the saw chain and be whipped toward you or pull you off balance.
13. When cutting a limb that is under tension be alert for spring back so that you will not be struck when the tension in the wood fibers is released.

continued on the back inside cover →

STIHL 031 AV, 031 AV electronic, 031 AV electronic Quickstop

Congratulations!

You are the owner of a precision-manufactured STIHL chain saw designed to give you long and dependable service. To receive maximum performance and satisfaction from your STIHL chain saw, it is important that you read and understand the maintenance and safety precautions before using your saw. Contact your STIHL Dealer or the STIHL Distributor for your area if you do not understand any of the instructions or warnings in this Manual.

This Manual contains warnings regarding your saw, operating and safety instructions for all STIHL 031 series power saws.

Warning!

Because a chain saw is a high-speed wood-cutting tool, some special safety precautions must be observed as with any other power saw to reduce the risk of personal accidents. Careless or improper use may cause serious or even fatal injury.

It is important that you fully understand the contents of this Manual and that you allow only persons who understand this Manual to operate your chain saw.

Pay special attention to the cutting techniques and safety precautions outlined on pages 4 to 19.

STIHL's philosophy is to continually improve all of its products. As a result, engineering changes and improvements are made from time-to-time. Written notices relating to such changes are sent to STIHL Dealers and are available to you. If the operating characteristics or the appearance of your saw differs from those described in this Manual, please contact your local STIHL Dealer for updated information and assistance.

Instruction Manual/Owner's Manual, Sharpening and Maintenance of Saw Chains

Contents

Parts of the Chain Saw	2
Safety Precautions	4
– The Operator	4
– The Saw	6
– The Use of the Saw	6
– Maintaining and Storing the Saw	19
Fuel	20
Chain Oil	20
Mounting Guide Bar and Chain	21
Chain Brake	22
Starting	24
Oil Quantity Control	26
Cutting Attachment	27
Replacing Chain Sprocket	29
Air Filter	30
Carburetor	31
Rewind Starter	32
Maintenance Chart	34
Specifications	35
Sharpening and Maintenance of Saw Chain	37

STIHL[®]

Andreas Stihl
Postfach 1760

D-7050 Waiblingen

Parts of the Chain Saw

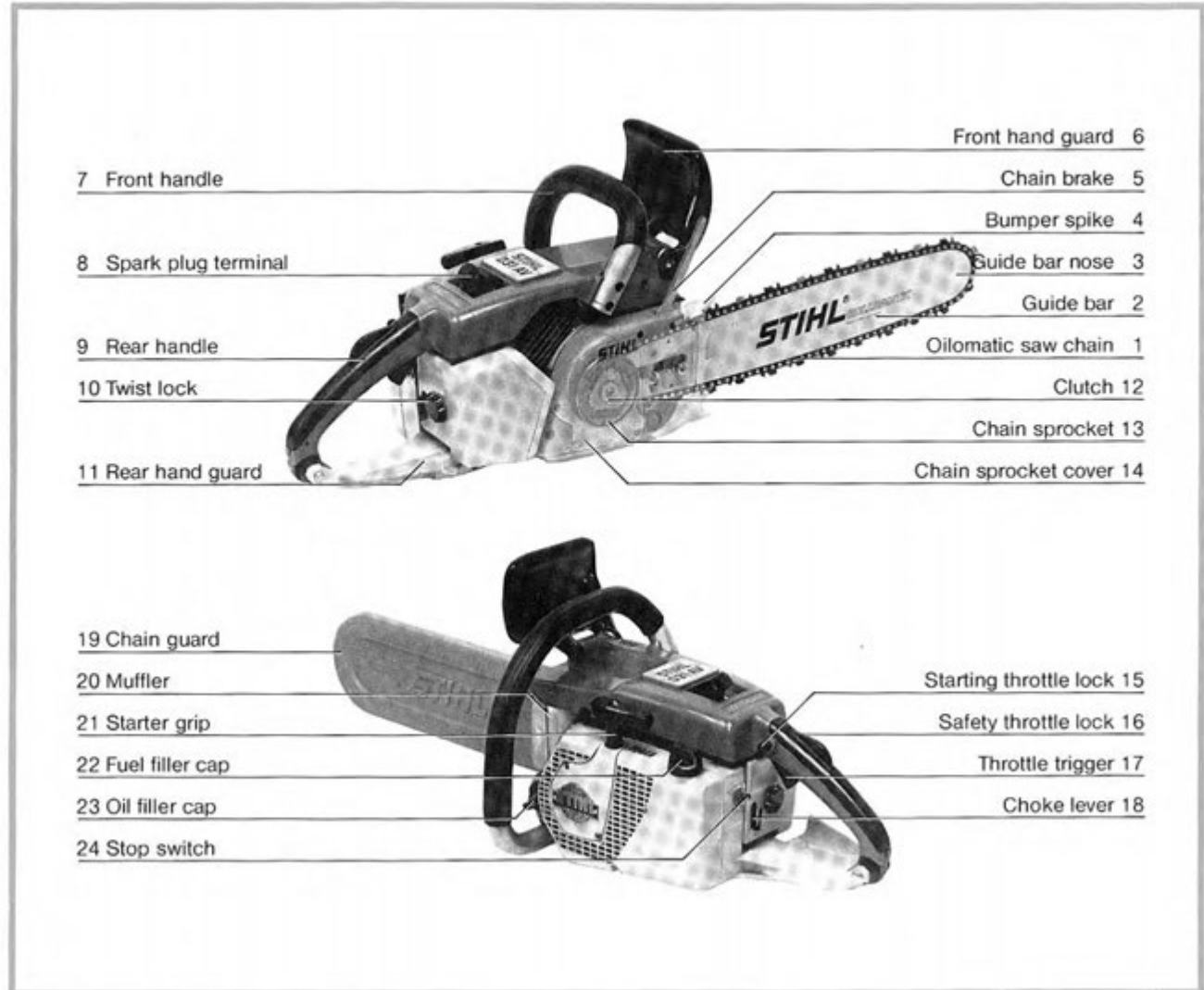

Definitions

1. **Oilomatic Saw Chain.** A loop consisting of cutters, tie straps and drive links.
 2. **Guide Bar.** Supports and guides the saw chain.
 3. **Guide Bar Nose.** The exposed part of the guide bar.
 4. **Bumper Spike.** Toothed stop for holding saw steady against wood.
 5. **Chain Brake.** An optional device to stop the rotation of the chain if activated by the operator's hand in a kickback situation.
 6. **Front Hand Guard.** Provides protection against projecting branches and helps prevent the left hand from touching the chain if it slips off the handle bar.
 7. **Front Handle.** Handle bar for the left hand at front of saw.
 8. **Spark Plug Terminal.** Connects the spark plug with the ignition wire.
 9. **Rear Handle.** The support handle for the right hand, located at or toward the rear of the saw.
 10. **Twist Lock.** Lock for carburetor box cover.
 11. **Rear Hand Guard.** Gives added protection to operator's right hand.
 12. **Clutch.** Couples engine to chain sprocket when engine is accelerated beyond idle speed.
 13. **Chain Sprocket.** The toothed wheel that drives the saw chain.
 14. **Chain Sprocket Cover.** Covers the clutch and the sprocket.
 15. **Starting Throttle Lock.** Keeps the throttle partially open during starting.
 16. **Safety Throttle Lock.** Must be depressed before activating the throttle trigger.
 17. **Throttle Trigger.** Controls the speed of the engine.
 18. **Choke Lever.** Eases engine starting by enriching mixture.
 19. **Chain Guard (Scabbard).** Protects the operator from touching the chain.
 20. **Muffler.** Attenuates exhaust noises and diverts exhaust gases in required direction.
 21. **Starter Grip.** The grip of the pull starter, which is the device to start the engine.
 22. **Fuel Filler Cap.** For closing the fuel tank.
 23. **Oil Filler Cap.** For closing the oil tank.
 24. **Stop Switch.** Switches the engine's ignition system off and stops the running of the engine.
- Chain Catching Bolt.** Catches a broken chain and guides it inside the chain sprocket cover (not illustrated).

Safety Precautions



The use of any chain saw may be hazardous. The saw chain has large, sharp cutters. If the cutters contact your flesh, they will cut you, even if the chain is not moving. At full throttle, the chain speed can reach 45 mph (20 m/s). It is important that you read, fully understand and observe the following safety precautions and warnings. Read the owner's manual **and** the safety instructions periodically. Pay special attention to the section on reactive forces, pages 10 to 13.

Warning!

Reactive forces, including kickback, can be dangerous. Careless or improper use of any chain saw may cause serious or fatal injury.

All safety precautions that are generally observed when working with an axe or a hand saw also apply to the operation of chain saws. However, because a chain saw is a highspeed, fast cutting power tool, special safety precautions must be observed to reduce the risk of personal accidents.

Have your STIHL dealer show you how to operate your chain saw. Observe all applicable local safety regulations, standards and ordinances.

Warning!

Minors should never be allowed to use a chain saw.



Bystanders, especially children and animals should not be allowed in the area where a chain saw is in use (ill. 1). Never let the saw run unattended. Store it in a locked place away from children and empty the fuel tank before storing for longer than a few days.

Do not lend your chain saw without the Owner's Manual. Be sure that anyone using your saw understands the information contained in this Manual.

These safety precautions and warnings apply to the use of all STIHL chain saws. Different models may have different parts and controls. See the appropriate section of your Owner's Manual for a description of the controls and function of the parts of your model saw.

Safe use of a chain saw involves

1. the operator
2. the saw
3. the use of the saw.

THE OPERATOR

Physical Condition

You must be in good physical condition and mental health and not under the influence of any substance (drugs, alcohol), which might impair vision, dexterity or judgment.

Do not operate a chain saw when you are fatigued (ill. 2). Be alert – If you get tired while operating your chain saw, take a break, tiredness may result in loss of control. Working with any chain saw can be strenuous. If you have any condition that might be aggravated by strenuous work, check with your doctor before operating a chain saw.

Warning!

Prolonged use of chain saws (or other machines) exposing the operator to vibrations may produce Whitefinger disease (Raynaud's phenomenon). This phenomenon reduces the hand's ability to feel and regulate temperature, produces numbness and burning sensations and may cause nerve and circulation damage and tissue necrosis. Many STIHL models are available with an anti-vibration system designed to reduce engine vibration. An anti-vibration system is recommended for those using chain saws on a regular or sustained basis.

Heated handles help to reduce the risk of Whitefinger disease and are recommended for cold weather use. Most STIHL powerheads are available with heated handles.

Anti-vibration systems and heated handles do not guarantee that you will not sustain Whitefinger disease. Therefore continual and regular users should monitor closely their use of chain saws and their physical condition.

Proper Clothing

Clothing must be sturdy and snug-fitting, but allow complete freedom of movement. Avoid loose-fitting jackets, scarfs, neckties, jewelry, flared or cuffed pants, or anything that could become entangled with the saw or brush. Wear overalls or jeans with a reinforced cutting resistant insert (ill. 3).

Protect your hands with gloves when handling saw and saw chain. Heavy-duty, nonslip gloves improve your grip and protect your hands.



Good footing is most important in chain saw work. Wear sturdy boots with nonslip soles. Steel-toed safety boots are recommended.

Proper eye protection is a must. Non-fogging, vented goggles or a face screen is recommended. Their use reduces the risk of eye injury.

Wear an approved safety hard hat to protect your head. Chain saw noise may damage your hearing. Always wear sound barriers (ear plugs or ear muffs) to protect your hearing.

Continual and regular users should have their hearing checked regularly.



THE SAW

Parts of the chain saw; illustrations and definitions of the parts see pages 2 and 3!

Warning!

Never modify a chain saw in any way. Only attachments supplied by STIHL or expressly approved by STIHL for use with the specific STIHL saw models are authorized. Although certain unauthorized attachments are useable with the STIHL powerhead, their use may, in fact, be extremely dangerous.

THE USE OF THE SAW

Transporting the chain saw

Warning!

Always stop the engine before putting a chain saw down or carrying it. Carrying a chain saw with the engine running is extremely dangerous. Accidental acceleration of the engine can cause the chain to rotate. Avoid touching the hot muffler.

6 **By hand:** When carrying your saw by hand, the engine



must be stopped and the saw must be in the proper position. Grip the front handle and place the muffler at the side away from the body (ill. 4).

The chain guard (scabbard) should be over the chain and the guide bar which should point backwards. When carrying your saw the bar should be behind you (ill. 5).

By vehicle: When transporting in a vehicle, keep chain and bar covered with the chain guard. Properly secure your saw to prevent turnover, fuel spillage and damage to the saw.

Preparation for the use of the saw

Take off the chain guard and inspect for safety in operation. For assembly please follow the procedure described on pages 21 and 22.

STIHL-Oilomatic chain, guide bar and sprocket must match each other.

If the guide bar or chain is replaced, it must be with a bar or chain of the same type. Replacement with another type of guide bar or chain will seriously increase the chances of operator injury due to the contact of the moving chain with the operator during rotational kickback.



Warning!

Proper tension of the chain is extremely important. In order to avoid false setting the tensioning procedure must be followed as described on pages 21 and 22. Make always sure the hexagonal nuts for the sprocket cover are tightened securely after tensioning the chain. Check chain tension once more after having tightened the nuts and thereafter at regular intervals (whenever the saw is cut off). If the chain becomes loose while cutting, shut off the engine and then tighten. Never try to tighten the chain while the engine is running!

Fueling

Your STIHL chain saw uses an oil-gasoline mixture for fuel (see page 20).

Warning!

Gasoline is an extremely flammable fuel. Use extreme caution when handling gasoline or fuel mix. Do not smoke or bring any fire or flame near the fuel (ill. 6).

Fueling Instructions

Fuel your chain saw in well-ventilated areas, outdoors only.

Always shut off the engine and allow it to cool before



refueling. Relieve fuel tank pressure by loosening fuel cap slowly.

Select bare ground for fueling and move at least 25 feet (7.5 m) from fueling spot before starting the engine.

Wipe off any spilled fuel before starting your saw and check for leakage.

Check for fuel leakage while refueling and during operation. If fuel or oil leakage is found, do not start or run the engine until leak is fixed and spilled fuel has been wiped away.

Starting

Warning!

Your chain saw is a one-person saw. Do not allow other persons to be near the chain saw. Start and operate your saw without assistance.

For safe and specific starting instructions, see the appropriate section of this manual on pages 24 to 26.

Do not drop start. This method is very dangerous because you may lose control of the saw (ill. 7).

Place the chain saw on firm ground or other solid surface in an open area. Maintain a good balance and secure footing.

Be absolutely sure that guide bar and chain are clear of you and all other obstructions and objects, including the ground; because when the engine starts at starting-throttle, engine speed will be fast enough for the clutch to engage sprocket and turn the chain, which may cause kickback to occur.

Engage the chain brake when starting a Quickstop model (see page 24).

Never attempt to start the saw when the guide bar is in a cut or kerf.

When you pull the starter grip, don't wrap the rewind starter around your hands. Do not allow the grip to snap back, but guide the starter rope slowly back to permit the rope to rewind properly. Failure to follow this procedure may result in injury to hand or fingers and may damage the starter mechanism.

Working Conditions

Operate your chain saw only outdoors in a ventilated area. Operate the saw under good visibility and daylight conditions only.

Warning! Take extreme care in wet and freezing weather (rain, snow, ice). Put off the work when the weather is windy, stormy or rainfall is heavy. Clear the area where you are working.

Warning! Avoid stumbling on obstacles such as stumps, roots or rocks and watch out for holes or ditches. Be extremely cautious when working on slopes or uneven ground. There is increased danger of slipping on freshly debarked logs.

Cutting Instructions

Grip: Always hold the saw firmly with both hands when the engine is running. Place your left hand on front handle

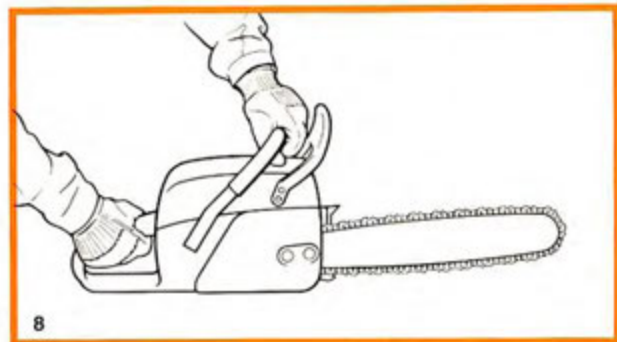

bar and your right hand on rear handle and throttle trigger. Left-handers should follow this instruction too.

Wrap your fingers tightly around the handles, keeping the handles cradled between your thumb and forefinger (ill. 8). With your hands in this position, you can best oppose and absorb the push, pull and kickback forces of your saw without having it slip out of your grip (see section of reactive forces). Make sure your chain saw handles and grip are in good condition and free of moisture, pitch, oil or grease.

Warning! Never use the saw with one hand. You cannot control reactive forces (see pages 10 to 13) and may lose control of the saw.

Important adjustments

Warning! At correct idle speed, chain should not turn. For directions to adjust idle speed, see the appropriate section of this Owner's Manual.

Do not use a saw with incorrect idle speed adjustment. Adjust the idle speed your-self according to the appropriate section of this manual.

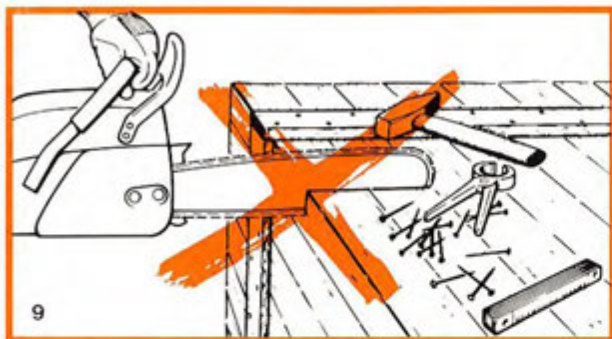

Have your STIHL Dealer check your saw and make proper adjustments or repairs.

After adjusting a chain start the saw, let the engine run for a while, then switch engine off and recheck chain tension. Proper chain tension is very important at all times.

Warning! Never touch a rotating chain with your hand or any part of your body.

Warning!

Do not cut any material other than wood or wooden objects.

Use your chain saw for cutting only. It is not designed for prying or shoveling away limbs, roots or other objects.

When sawing, make sure that the saw chain does not touch any foreign materials such as rocks, nails and the like (ill. 9). Such objects may be flung off, damage the saw chain or cause the saw to kick back.

In order to keep control of your saw, always maintain a firm foothold. Never work on a ladder, in a tree or on any other insecure support. Never use the saw above shoulder height (ill. 10).

Position the chain saw in such a way that your body is clear of the cutting attachment whenever the engine is running. Stand to the left of cut while bucking (see ill. 11).

Don't put pressure on the saw when reaching the end of a cut. The pressure may cause the bar and rotating chain to pop out of the cut or kerf, go out of control and strike the operator or some other object. If the rotating chain strikes some other object a reactive force (see pages 10 to 13) may cause the chain to strike the operator.



Reactive forces during the cut, including kickback

Warning!

Reactive forces, that may occur during any cut are kickback, pushback and pull-in. Reactive forces can be dangerous! In any chain saw, the powerful force used to cut wood can be reversed (and work against the operator). If the rotating chain is suddenly stopped by contact with any solid object like a log or branch or is pinched, the reactive forces instantly occur. These reactive forces may result in loss of control which may, in turn, cause serious or fatal injury. An understanding of the causes of these reactive forces may help you avoid loss of control.

The most common reactive forces are

- kickback,
- pushback,
- pull-in.

Kickback:

Kickback occurs when the upper quadrant of the bar nose contacts a solid object in the wood or is pinched (ill. 12). The reaction of the cutting force of the chain causes a rotational force of the chain saw in the direction opposite to the chain movement, mainly in the plane of the bar. This may fling the bar in an uncontrolled arc mainly in the plane of the bar.

Under some circumstances the bar moves towards the operator who may suffer severe or fatal injury. It may also occur during limbing. It also occurs when the nose of the guide bar is pinched unexpectedly, unintentionally contacts solid material in the wood (ill. 13) or is incorrectly used to begin a plunge or boring cut.

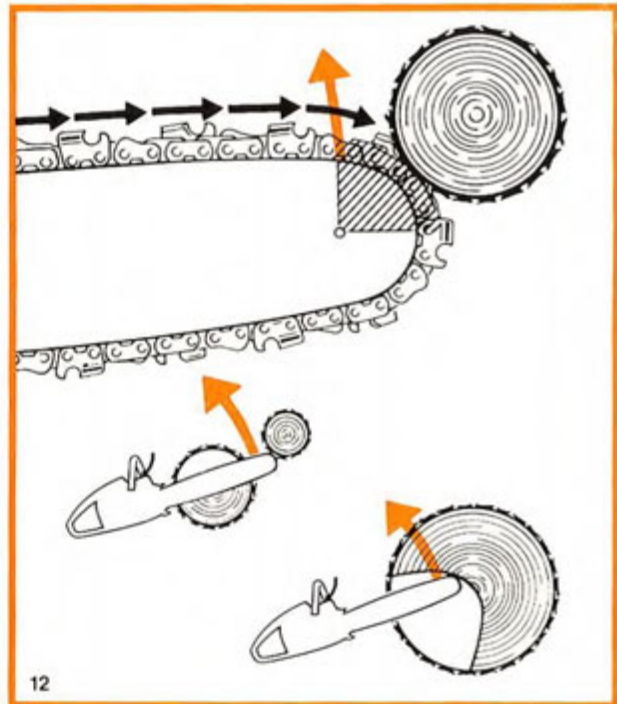

12

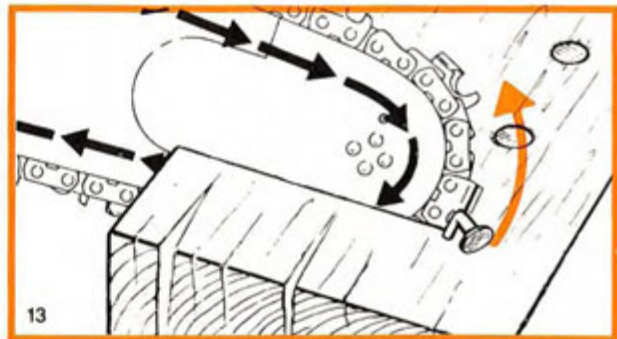

13

The greater the force of the kickback reaction, the more difficult it becomes for the operator to control the saw.

Many factors influence the occurrence and force of the kickback reaction. The type of bar and saw chain you use is a factor in the force of the kickback reaction.

The radius of the guide bar nose.

Kickback tendency increase as the radius or size of the guide bar nose increases.

The speed of contact at which the cutter contacts the object.

Kickback forces increase with the rate of impact.

The contact angle between the nose of the bar and the foreign object (see ill. 12).

Kickback is most pronounced in the upper quadrant of the bar nose.

The saw chain.

Some **STIHL chain types** are designed to reduce kickback forces.

The depth gauges:

Improper lowering of the depth gauges also increases the chance of a kickback.

The sharpening condition:

An improperly sharpened chain increases the risk of a kickback.

To avoid kickback

The best protection from personal injury that may result from kickback is to avoid kickback situations:

1. Hold the chain saw firmly with both hands and maintain a secure grip.
2. Be aware of the location of the guide bar nose at all times.
3. Never bring the nose of the guide bar in contact with any object. Do not cut limbs with the nose of the guide bar. Be especially careful with small, tough limbs, small size brush and saplings which may easily catch the chain.
4. Don't overreach.
5. Don't cut above shoulder height.
6. Begin cutting and continue at full throttle.
7. Cut only one log at a time.
8. Use extreme caution when re-entering a previous cut.
9. Do not attempt plunge cuts (see page 16) if you are not experienced with these cutting techniques.
10. Be alert for shifting of the log or other forces that may cause the cut to close and pinch the chain.
11. Maintain saw chain properly. Cut with a correctly sharpened, properly tensioned chain at all times.
12. Stand to the side of the cutting path of the chain saw.



Warning!

Chain saw kickback may cause serious or fatal injury. To reduce the risk of kickback injuries STIHL recommends that you equip your saw with a narrow nose bar, low profile chain or other chain designed to reduce kickback forces, and a STIHL Quickstop.

Devices for reducing the risk of kickback injury

STIHL has developed a chain stopping system designed to reduce the risk of injury in a kickback situation. The device is called a Quickstop. The Quickstop is available as an option on many STIHL saws. This device does not prevent kickback, but will stop the chain in some kickback situations if the operator's left hand is in position to activate the Quickstop lever by contacting the front hand guard.

When a kickback occurs, the chain saw rotates in the plane of the bar. The left hand, when properly gripping the front handle behind the front hand guard should engage the Quickstop lever. This activates the Quickstop and stops the chain (see ill. 14).

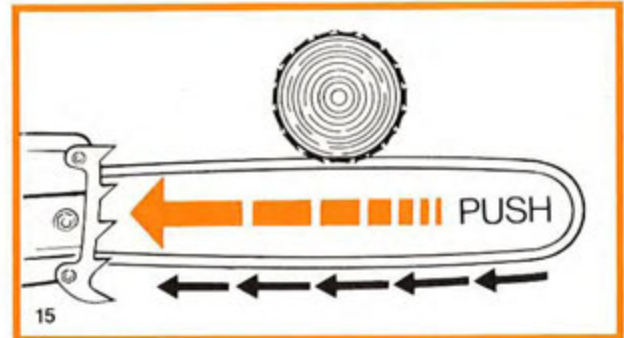

STIHL has developed guide bars with a small radius nose. These guide bars are designed to reduce the kickback tendency and are available as an option.

STIHL has developed chains with cutters whose configuration are designed to reduce kickback forces. These chains are available as an option.

Warning!

However, even if your saw has a "Quickstop" a narrow nose bar or a guard-link or a pro-guard chain, it does not guarantee that you will not be injured by a "kickback" and therefore, you should observe all of the precautions to prevent kickback discussed previously.

Pushback:

Pushback occurs when the chain on the top of the bar is suddenly stopped when it is pinched, caught or encounters a foreign object in the wood. The reaction of the chain drives the saw straight back toward the operator causing loss of saw control. Pushback frequently occurs when the top of the bar is used for cutting (see ill. 15).

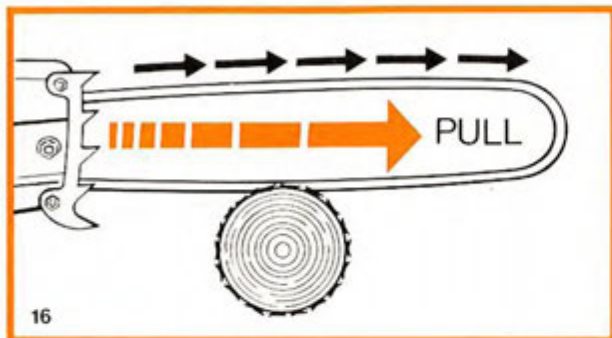

To avoid pushback

1. Be alert to forces or situations that may cause material to pinch the top of the chain.
2. Do not cut more than one log at a time.
3. Do not twist the saw when withdrawing the bar from a plunge cut or under buck cut (figures 26 to 28 and 34, pages 16, 17 and 19), because the chain can pinch.

Pull-in:

Pull-in occurs when the chain on the bottom of the bar is suddenly stopped. The chain on the bottom of the bar stops when it is pinched, caught or encounters a foreign object in the wood (see ill. 16). The reaction of the chain pulls the saw forward, causing the operator to lose control.

Pull-in frequently occurs when the bumper spike of the saw is not held securely against the tree or limb and when the chain is not rotating at full speed before it contacts the wood.

Warning!

Use extreme caution when cutting small size brush and saplings which may easily catch the chain and pull you off balance.

To avoid pull-in

1. Always start a cut with the chain rotating at full speed and the bumper spike in contact with the wood.
2. Pull-in may also be prevented by using wedges to open the kerf or cut.

Cutting Techniques

Felling

Felling is cutting down a tree.

Before felling a tree, consider carefully all conditions which may affect the direction of fall, including:

- The intended direction of the fall.
- The natural lean of the tree.
- Any unusually heavy limb structure.
- Surrounding trees and obstacles.
- The wind direction and speed.

Warning!

Always observe the general conditions of the tree. Look for decay and rot in the trunk. If it is rotted inside, it could snap and fall toward the operator while being cut.

Also look for broken or dead branches which could vibrate loose and fall on the operator. When felling on a slope, the operator should stand on the up-hill side if possible.

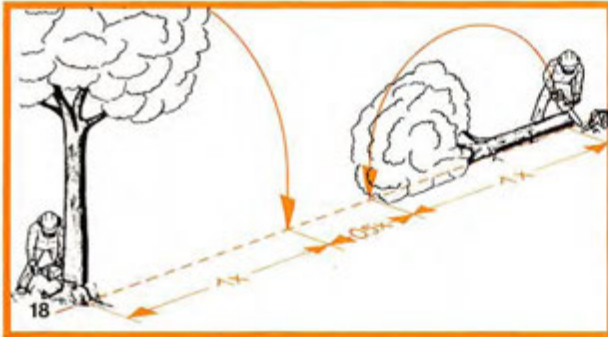

When felling in the vicinity of roads, railways and power lines, etc., take extra precautions (see ill. 17). Inform the police, utility company or railway authority before beginning to cut.

When felling, maintain a distance of at least 2½ tree lengths from the nearest person (see ill. 18).

14 Note: The noise of your engine may drown any warning call.

Felling Instructions:

First clear the tree base and work area from interfering limbs and brush and clean its lower portion with an axe (ill. 19).

Then, establish a path of escape and remove all obstacles. This path should be opposite to the planned direction of the fall of the tree and at a 45° angle (ill. 20). An alternate path must also be selected. Place all tools and equipment a safe distance away from the tree, but not on the escape path.



If the tree has large buttress roots, cut into the largest buttresses vertically first (horizontally next) and remove (ill. 21).

Then, determine the placement of the felling notch (ill. 22). The felling notch when properly placed determines the direction in which the tree will fall. It is made perpendicular to the line of fall and should be as close to the ground as possible. Cut the felling notch to a depth of about one-fifth to one-fourth of the trunk diameter (ill. 23). It should be in no case higher than it is deep. Make the felling notch very carefully.

Begin the felling cut slightly higher than the felling notch and on the opposite side of the tree (ill. 23). Then cut horizontally through towards the felling notch. Apply the chain saw with its spikes directly behind the uncut portion of wood and cut toward the notch (ill. 24). Leave approximately $\frac{1}{10}$ of the tree diameter uncut. This is the hinge (ill. 24). Do not cut through the hinge because you could lose control of the direction of the fall. Drive wedges into the felling cut where necessary to control the direction of the fall. Wedges should be of wood, light alloy or plastic – never of steel, which can cause kickback and damage to the chain.

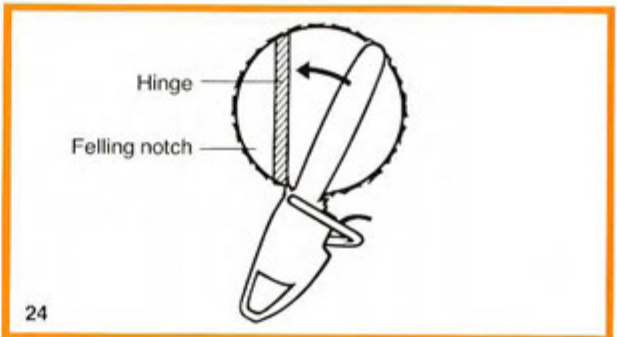
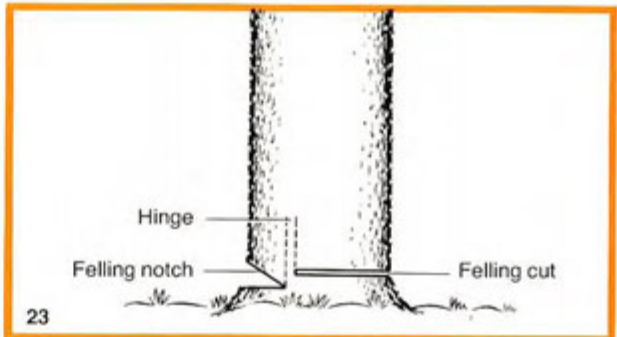
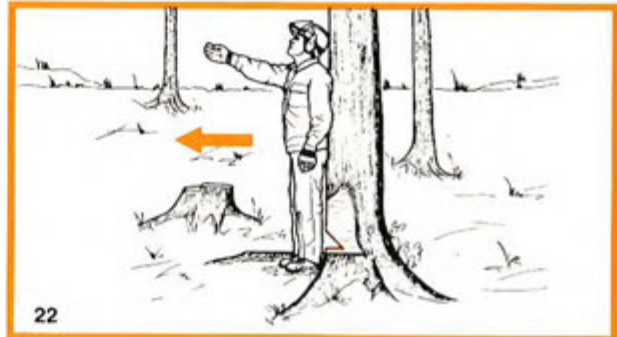

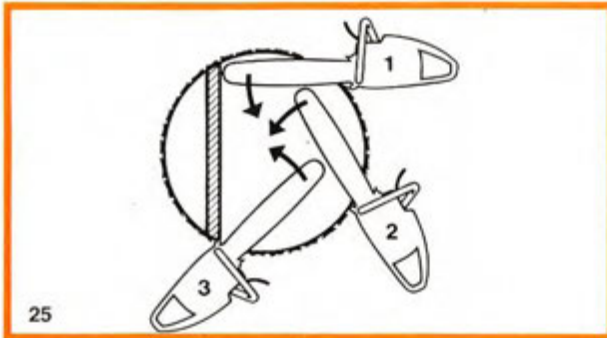

25

Always keep to the side of the falling tree. When the tree starts to fall, cut off the engine, withdraw the bar and walk away on the pre-planned escape path. Watch out for falling limbs.

Warning!

Be extremely careful with partially fallen trees which are poorly supported.

When the tree hangs or for some other reason does not fall completely, set the saw aside and pull the tree down with a cable winch, block and tackle or tractor. If you try to cut it down with your saw, you may be injured.

Sectioning Method

Warning!

Felling a tree that has a diameter greater than the length of the guide bar requires use of either the sectioning or plunge-cut method. These methods are extremely dangerous because they involve the use of the nose of the guide bar and can result in kickback. Only properly trained professionals should attempt these techniques.

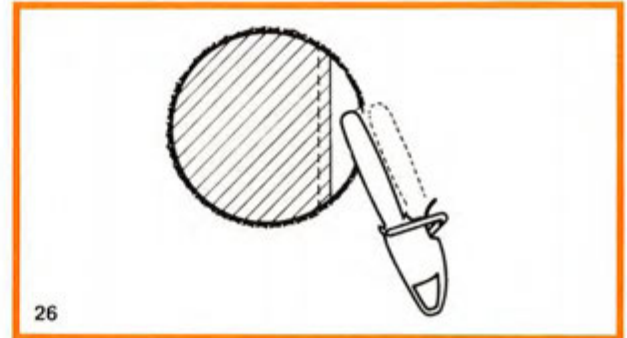

26

For the sectioning method (ill. 25) make the first cut with the guide bar fanning in toward the hinge. Then, using the bumper spike as a pivot, reposition the saw for the next cut. Avoid repositioning the saw more than necessary. When repositioning for the next cut, keep the guide bar fully engaged in the kerf to keep the felling cut straight. If the saw begins to pinch, insert a wedge to open the cut. On the last cut, do not cut the hinge.

Plunge-Cut Method

Timber having a diameter more than twice the length of the guide bar requires the use of the plunge-cut method before making the felling cut.

First, cut a large, wide notch. Make a plunge cut in the center of the notch.

The plunge cut is made with the guide bar nose. Begin the plunge cut by applying the lower portion of the guide bar nose to the tree at an angle (ill. 26). Cut until the depth of the kerf is about the same as the width of the guide bar

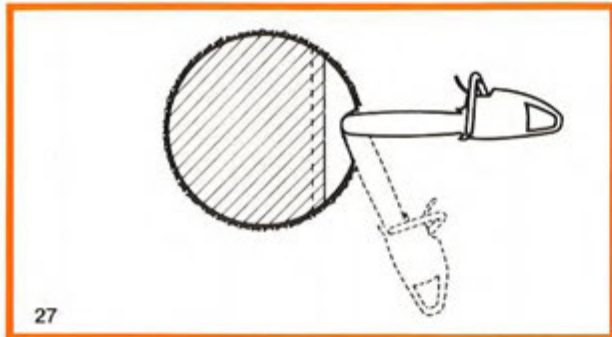

27

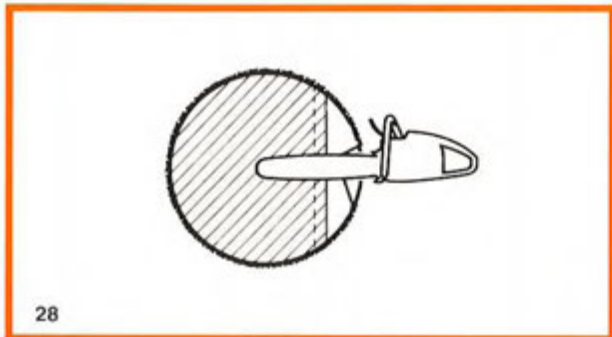

28

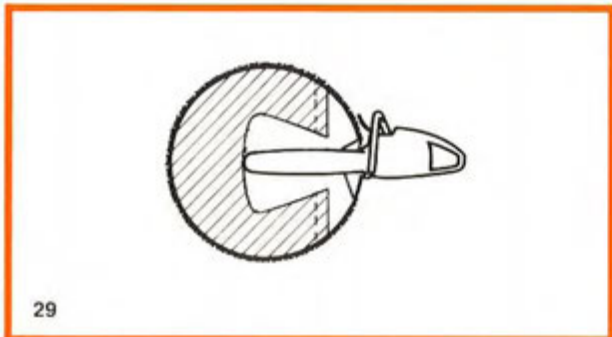

29

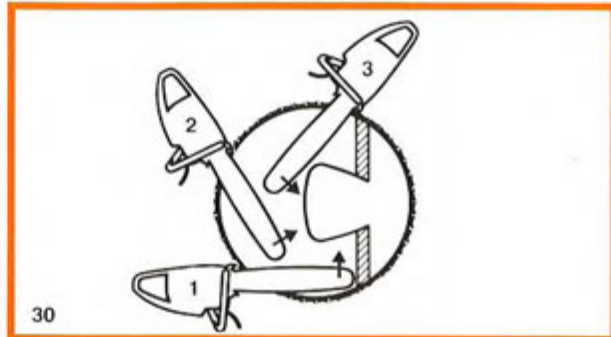

30

(ill. 27). Next, align the saw in the direction in which the recess is to be cut.

With the saw at full throttle, insert the guide bar in the trunk (ill. 28).

Enlarge the plunge cut as shown in illustration (ill. 29).

Warning!

There is an extreme danger of kickback at this point. Extra caution must be taken to maintain control of the saw. To make the felling cut, follow the sectioning method described previously (ill. 30).

If you are inexperienced with a chain saw plunge-cutting should not be attempted. Seek the help of a professional.

Limbing

Limbing is removing the branches from a fallen tree.

Warning!

There is an extreme danger of kickback during the limbing operation. Do not work with the nose of the bar. Be extremely cautious and avoid contacting the log or other limbs with the nose of the guide bar.

Do not stand on a log while limbing it – you may slip or the log may roll.



Start limbing by leaving the lower limbs to support the log off the ground (ill. 31). Always cut from the top of the limb. Do not underbuck freely hanging limbs. A pinch may result or the limb may fall, causing loss of control. If a pinch occurs, stop the engine and remove the saw, by lifting the limb.

Warning!

Be extremely cautious when cutting limbs under tension. The limb could spring back toward the operator and cause loss of control of the saw or injury to the operator.

Bucking

Bucking is cutting a log into sections.

Warnings!

1. When bucking, do not stand on the log. Make sure the log will not roll down-hill. If on a slope, stand on the up-hill side of the log (see ill. 32). Watch out for rolling logs.
2. Cut only one log at a time.
3. Shattered wood should be cut very carefully. Sharp slivers of wood may be caught and flung in the direction of the operator of the saw.



4. When cutting small logs, use a sawhorse (ill. 33). Never permit another person to hold the log. Never hold the log with your leg or foot.
5. Logs under strain require special attention to prevent the saw from pinching. The first cut is made on the compression side to relieve the stress on the log (see ill. 34, 35). The bucking cut is then made as shown. If the saw pinches, stop the engine and remove it from the log.
6. Only properly trained professionals should work in an area where the logs, limbs and roots are tangled (i.e. a

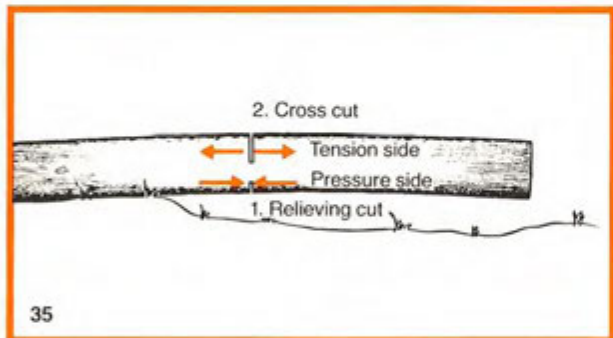
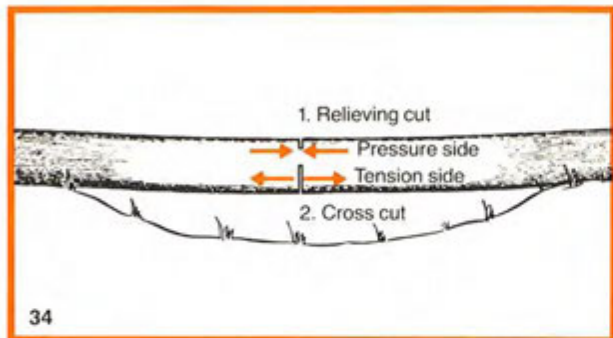

blowdown area, ill. 36). Working in blowdown areas is extremely hazardous.

7. Drag the logs into a clear area before cutting. Pull out exposed and cleared logs first.

Maintenance and Repair

Never operate a chain saw that is damaged, improperly adjusted or not completely or securely assembled. Follow the maintenance and repair instructions in the appropriate section of your Owner's Manual.

Warning!

Always stop the engine and make sure that the chain is stopped before doing any maintenance or repair work or cleaning the saw. Do not attempt any maintenance or repair work not described in your Owner's Manual. Have such work performed at your STIHL service shop only.

MAINTAINING AND STORING THE SAW

Keep the chain, bar and sprocket clean and lubricated; replace worn sprockets or chains.

Keep the chain sharp. You can spot a dull chain when easy-to-cut wood becomes hard to cut and burn marks appear on the wood.

Keep the chain at proper tension. Tighten all nuts, bolts and screws except the carburetor adjustment screws after each use.

Keep spark plug and wire connection tight and clean.

Store saws in a high or locked place, away from children.

Fuel

Fuel tank cap open

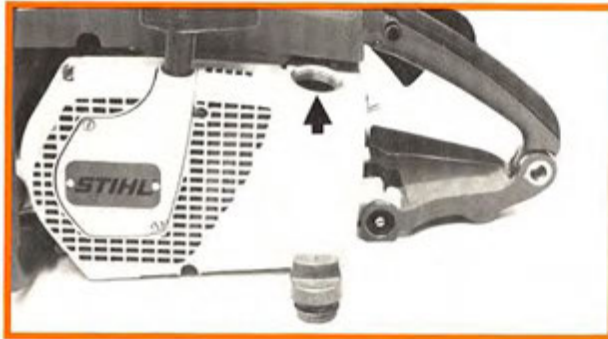

Your two-stroke engine is powered by a mixture of gasoline and engine oil.

Only regular gasoline may be used. Never use high octane gasoline as it contains benzol which would permanently damage the carburetor diaphragms.

Only use STIHL two-cycle engine oil or other branded two-cycle engine oils for mixing. The mix ratio is 1:40 (1 part oil to 40 parts regular gasoline) with STIHL two-cycle engine oil or 1:25 for other branded engine oils.

Important: Always shake mixture in fuel can vigorously before fueling.

Chain Oil

Oil filler cap open

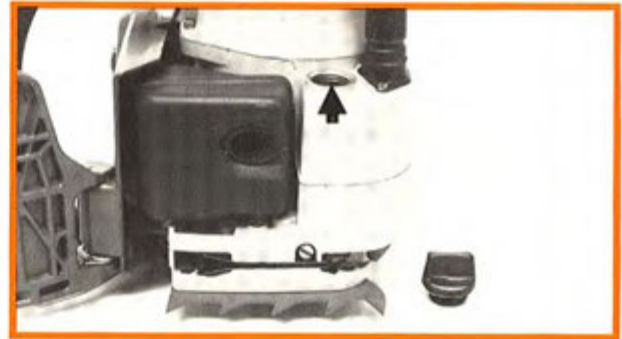

The service life of the cutting attachment (Oilomatic chain and guide bar) depends on good lubrication and the quality of the lubricating oil.

Never use waste oil for this purpose!

Always use the chain lubricating oil approved by STIHL and appointed dealers.

If special chain lubricating oil is not available, one of the high-duty, single grade engine oils listed below may be used in an emergency, depending on the outside temperature.

Outside temperature +10°C . . . +40°C: SAE 30
Outside temperature +10°C . . . -10°C: SAE 20
Outside temperature -10°C . . . -30°C: SAE 20 W or
SAE 10 W

Always top up with chain oil when you refuel. Carefully clean the area around the filler caps before opening and make sure that no dirt falls into the tank while you are refueling.

Mounting Guide Bar and Chain

Top: Backing off tensioning nut

Bottom: Locating the guide bar

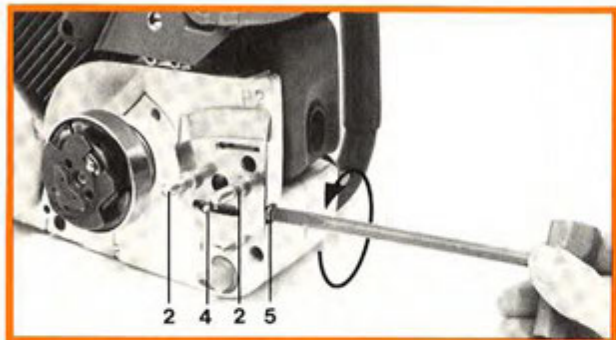

The guide bar and Oilomatic chain are supplied separately for safety reasons.

To mount them, first unscrew the collar nuts (1) from the stud bolts (2) and take off the sprocket cover (3). On Quickstop models the chain brake has to be disengaged – pull hand guard back toward the handle bar.

Now back off the chain tensioning nut (4) – below the

Top: Fitting the Oilomatic chain

Bottom: Cutting edges face the bar nose



stud bolts (2) – by turning the tensioning screw (5) counter-clockwise to the end of its thread.

Locate slot of guide bar over the stud bolts (2) so that the lug of the tensioning nut (4) engages in the lower fixing hole (6).

Starting at the chain sprocket, place the Oilomatic chain on the guide bar so that cutting edges on the top of the bar are facing the bar nose (7). Fit chain sprocket cover (3) on the stud bolts (2) and tighten collar nuts (1) temporarily by hand.

Top: Tensioning the Oilomatic chain
Bottom: Checking chain tension

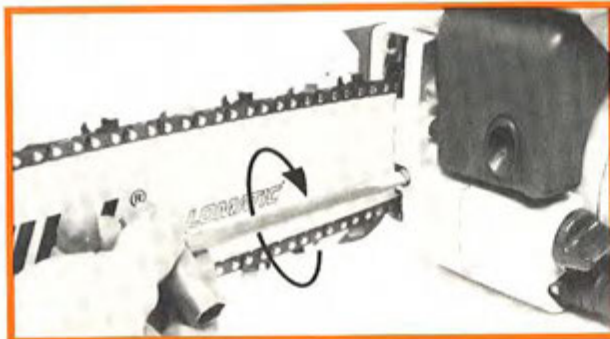

Now tension the Oilomatic chain by turning the tensioning screw (5) clockwise, making sure that the drive link tangs are lined up with the bottom groove of the bar. Hold the bar nose (7) up and turn tension screw (5) until the Oilomatic chain is properly seated on the underside of the bar. While still holding the bar nose up, tighten the collar nuts (1) securely.

The Oilomatic chain is correctly tensioned when it fits snugly on the underside of the bar but can still be pulled easily around the bar.

Chain brake (Optional Equipment)

Chain brake actuated



The chain brake (only on Quickstop models) increases operator safety and is actuated by the front hand guard.

Engaging the chain brake

When the hand guard is moved towards the guide bar nose, the brake lever is unlatched by the actuating lever. The saw chain is brought to a standstill and locked within a fraction of a second.

Releasing the chain brake

The locked saw chain must be released before cutting can be continued. To do this, pull the hand guard back against the handle bar, this disengages the brake band.

Important: With the exception of emergency situations and starting, the chain brake may be engaged only at idle speed.

Starting

Chain brake engaged



Start your saw without assistance of a second person. Keep other people clear of the general work area of the saw.

Place the chain saw on firm ground or other solid surface in an open area. Have a good balance and secure footing. Be absolutely sure that guide bar and chain are clear of you and all other obstruction and objects, including the ground. When engine starts (in half-throttle position), engine speed will be fast enough for the clutch to engage sprocket and turn the chain.

Starting procedure

1. Engage the chain brake on **Quickstop machines** by pushing the hand guard (1) toward the bar.
2. Move ignition stop switch (2) away from "STOP".
3. **A cold engine** is started with the choke lever (3) at "CHOKE" (horizontal position).

A warm engine, or one that has only been stopped for a brief period, is started with the choke lever (3) away from "CHOKE" (vertical position).

Top: Ignition stop switch away from "STOP"
Center: Choke lever in "CHOKE" position (cold-start)
Bottom: Choke lever away from "CHOKE" (warm-start)

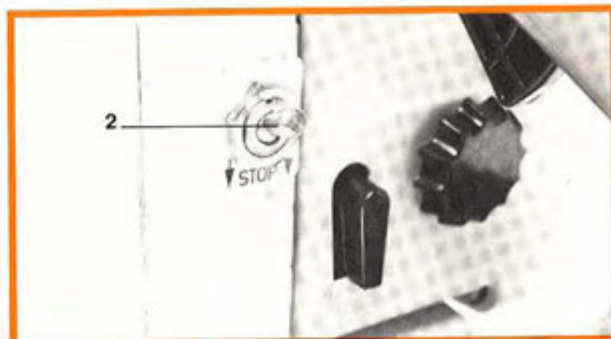

Half-throttle position

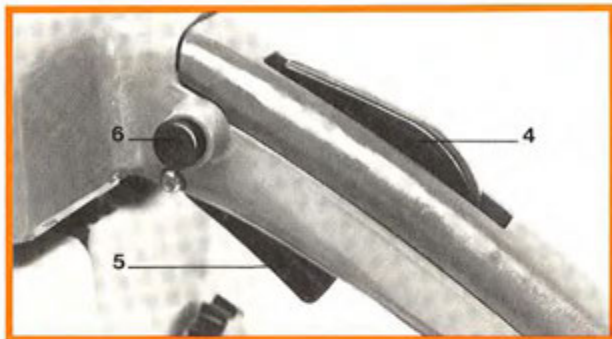

4. Set throttle trigger to half-throttle position: Depress at first safety throttle lock (4), then throttle trigger (5) and half-throttle button (6). Next release throttle trigger (5) and half-throttle button (6).
5. Hold the chain saw with your left hand at the front handle bar and put your right foot through rear handle.
6. Pull starter grip slowly with your right hand until you feel the starter engage. Then make a short, quick pull. Do not allow the grip to snap back, but guide the starter rope slowly back to permit the rope to rewind properly. Crank until the engine fires. Then slide choke lever (3) away from "CHOKE" (vertical position), if the engine is cold and pull again. Failure to follow this procedure may result in injury to hand or fingers and may damage the starting mechanism.
7. As soon as engine is running, depress throttle trigger (5) momentarily to release half-throttle button (6) and allow the engine to run on idle speed.
8. On Quickstop-machines disengage the chain brake by pushing the hand guard (1) towards front handle bar before starting cutting work.
9. The engine is stopped by moving the ignition stop switch (2) to the "STOP" position.

- Top: Starting
Center: Chain brake disengaged
Bottom: Ignition stop switch in "STOP" position

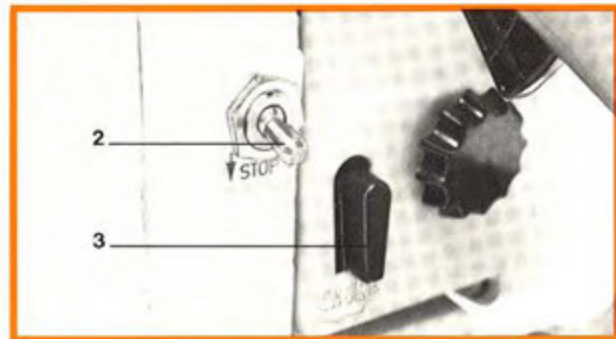
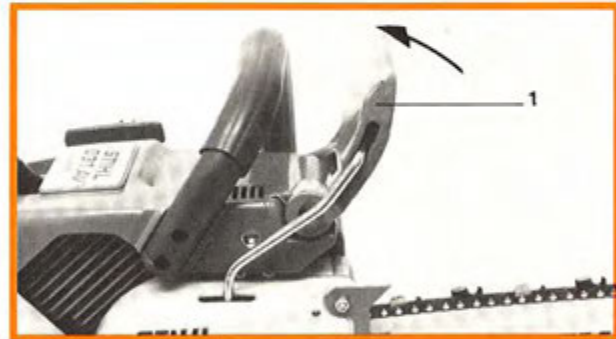

Other points to be observed when starting the engine:

The choke lever is mechanically connected to the carburetor's choke valve. The choke valve is closed when the choke lever is on "Choke" and open when the choke lever is moved away from "Choke".

When starting a cold engine only keep the choke lever in the "Choke" position until the engine begins to fire. Then open choke fully — choke lever away from "Choke" — even if the engine stops and you have to repeat the starting procedure. If the choke lever is left in the "Choke" position, the combustion chamber will flood and stall the engine.

If you moved the choke lever away from the "Choke" position after the engine fired and the engine still does not run after several attempts, it is already flooded. In such a case, remove and dry off the spark plug. Clear the combustion chamber by cranking the engine over several times on the starter with the spark plug still removed and the stop switch in the "STOP" position. When you now try to start, move the choke lever away from "Choke" — even if the engine is cold — and set the throttle trigger to the starting-throttle position.

In very cold weather only open the choke slightly after starting — move choke lever to center position. Allow engine to warm up for a brief period at half-throttle. Then move choke lever away from "Choke" and disengage the starting-throttle lock.

A new engine or one which has been run until the fuel tank is dry will not start first time after fueling because the carburetor's diaphragm pump only delivers sufficient fuel after the engine has been turned over several times.

Oil Quantity Control

Oil quantity control bolt

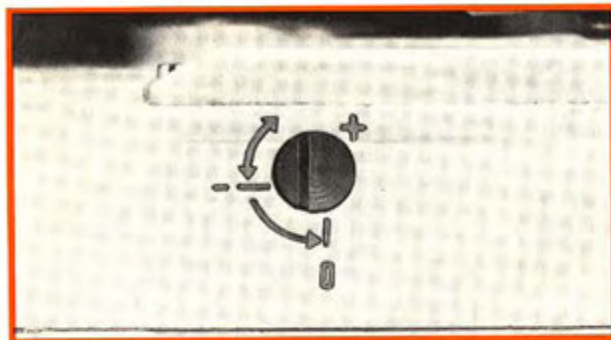

The feed rate of the chain oil pump can be adjusted by means of the control bolt which is positioned on the underside of the crankcase. The oil feed rate is increased by turning the control bolt clockwise in the plus (+) direction or decreased by turning it counterclockwise in the minus (-) direction.

In order to insure adequate lubrication of the cutting attachment at all times, the control bolt should always be turned fully in the plus (+) — maximum feed — direction. A reduction in the chain oil feed rate is advisable only if very short cutting attachments are used.

To shut off the chain oil supply completely, e. g. to test the powerhead without the chain and guide bar, turn the control bolt to minus (-) and then press it in and turn it as far as the "O" position.

Cutting Attachment

- 1 Oil inlet borings
- 2 Centering borings

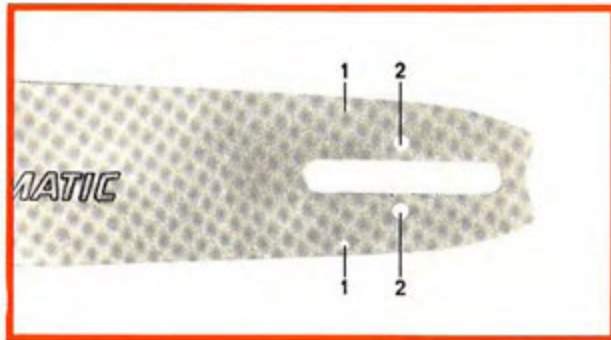

The cutting attachment of a chain saw consists of the guide bar, saw chain and chain sprocket.

Guide bar

The nose and underside of the guide bar are subject to a particularly high rate of wear. To avoid one-sided wear, turn the bar around every time you sharpen or replace the chain. Regular cleaning of the oil inlet holes and guide bar groove is also important. The bar can be examined for signs of wear at the same time.

A minimum bar groove depth of 6 mm (0.24 in) must be maintained in order to prevent the drive links fouling the bottom of the groove (the heels of the cutter and tie strap would no longer locate on the guide bar track).

This depth should be measured at the point where the bar is stressed most, i.e. the bar nose on Duromatic bars and the area where most of the cutting is done on Rollomatic bars. The guide bar must be replaced if the minimum depth cannot be maintained.

On Rollomatic guide bars the bearing of the nose sprocket must also be lubricated at regulated intervals with the appropriate grease gun. Lubricate at least once daily under normal operating conditions. Only use a high grade grease for refilling the grease gun, e.g. refill tube 0781 120 1111.

To lubricate, place chain saw on its side so that the bar nose is firmly supported. Clean the grease hole and pump in grease while slowly pulling saw chain around bar (sprocket rotates) so that bearing is uniformly filled. When grease emerges at the hole on the other side of the bar or around the nose sprocket, repeat the procedure on the other side.

The sprocket nose bearing should be greased more often if the cutting attachment is used in damp conditions, e.g. working in snow. After finishing cutting work the sprocket nose should be thoroughly greased from both sides to force moisture out of the bearing and prevent corrosion.

Chain lubrication

Never operate the chain saw without proper chain lubrication. Check operation of chain lubrication and level in oil tank before starting work.

Hold chain saw with mounted cutting attachment over a light background. Take care, the Oilomatic chain must not touch the ground, i. e. keep it at least 20 cm (8 in) clear of the ground. Run the engine with half-throttle position. If an increasing patch of oil can be seen, chain lubrication is operating correctly.

Checking chain lubrication

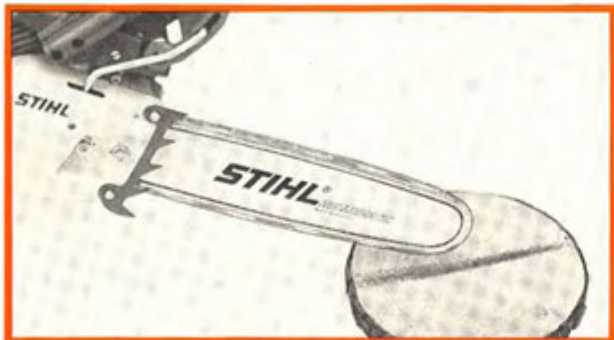

Breaking in Oilomatic chain

Every new chain has to be broken in for about 2 to 3 minutes. Ample chain lubrication is essential during this period. After breaking in, check chain tension and adjust if necessary.

Correct chain tension

The Oilomatic chain must always be slackened off after finishing cutting work. A chain properly tensioned when it is warm would, when the temperature drops, be subjected to such great contraction stresses that it would break and also damage the crankshaft and bearings.

The Oilomatic chain must, therefore, always be tensioned — with the engine switched off — before you start cutting. Chain tension is correct in the cold condition when the chain fits snugly on the underside of the bar and can still be moved along the bar by hand. Extreme care must be taken as the cutting edges are very sharp.

Worn chain sprocket

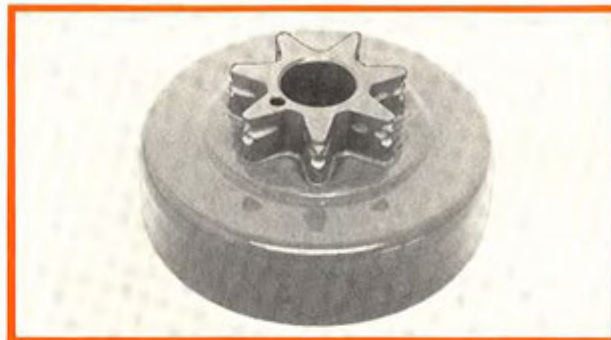

When the chain saw is operated at extremely low outside temperatures a correctly cold-tensioned Oilomatic chain will begin to sag noticeably as it warms up to normal operating temperature. The chain must then be retensioned. However, the chain must be slackened off again **immediately** after shutting down the saw. This is necessary to avoid contraction stress which would occur as the chain cools down to ambient temperature.

A new chain must be retensioned more frequently than a used one until it has stretched fully.

Chain sprocket

The stress and strain on the chain sprocket are particularly high. If the wear marks on the teeth are very pronounced (about 0.5 mm/ 0.02 in deep), the sprocket should be replaced. A worn sprocket reduces the service life of the saw chain. The chain sprocket should be replaced as a matter of routine with every second Oilomatic chain. It is best to use two saw chains alternately with one sprocket.

Replacing Chain Sprocket

Release the chain brake on Quickstop models by pushing the hand guard toward the handle bar. Remove the chain sprocket cover, cutting attachment and starter cover. Pull off the spark plug terminal and then unscrew the spark plug with the combination wrench. Fit the locking screw in the spark plug hole and tighten it down by hand. Turn the crankshaft clock-wise until the piston butts against the locking screw and thus locks the crankshaft. Now use the combination wrench to unscrew the clutch spider.

Caution: The clutch spider has a left-hand thread – unscrew in clockwise direction.

After removing clutch, take thrust washer, chain sprocket, needle cage and cover plate off crankshaft in that order.

Clean stub of crankshaft, wash out needle cage with clean gasoline and lubricate with anti-friction bearing grease.

The reverse sequence is used for assembly of the new chain sprocket. Before installing the cover plate, check that press-fitted driving pin is in good condition. If it is damaged, loose or broken, fit a new cover plate. Moreover, make sure during assembly that the driving pin is located in the worm bore and the bore in the chain sprocket.

Once the clutch is installed on the crankshaft, tighten the clutch spider to a torque of 4.0 kpm (50 lb. ft). This is best done with a torque wrench.

Finally, remove locking screw, insert and tighten down spark plug and refit starter cover.

Top: Tightening clutch spider with combination wrench
Center: Tightening clutch spider with torque wrench
Bottom: Parts in correct order

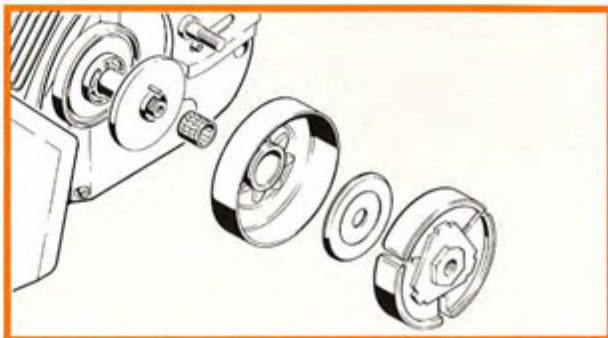
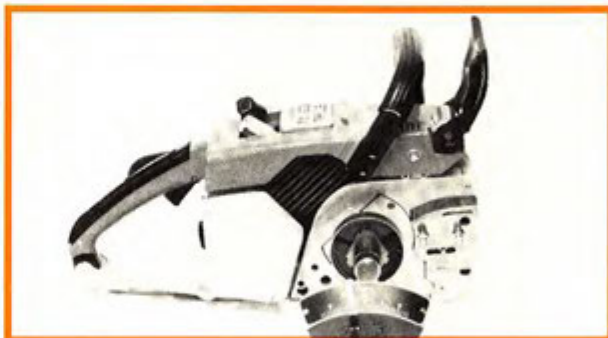

Air Filter

The air filter's function is to intercept dust and dirt in the intake air and thus reduce wear on engine components.

Clogged air filters have a detrimental effect on engine performance, increase fuel consumption and make starting more difficult.

The air filter must be cleaned daily — or more frequently in very dusty operating conditions.

Turn twist lock counterclockwise and pull off carburetor box cover toward chain. Clean area around filter before removing. Use a screwdriver to remove the two slotted nuts. The two-piece air filter can now be lifted off the studs. The two halves of the filter can be prised apart with a screwdriver.

For daily cleaning it is sufficient to clean both parts of the filter with a soft brush.

However, the air filter should be washed in clean gasoline at least once a week and blown out with compressed air if available.

If the wire mesh is damaged on either half of the air filter, always fit a new part.

Reverse the above sequence to install the air filter, making sure that the choke valve is mounted in the filter.

It is advisable to carry a spare filter with you at all times and clean the dirty filter in the workshop.

Top: Releasing slotted nuts
Bottom: Prising apart the two halves of the filter

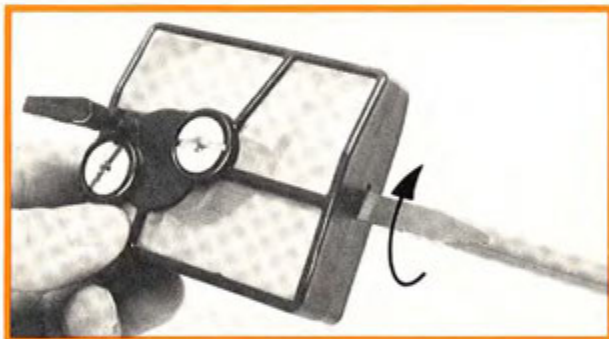
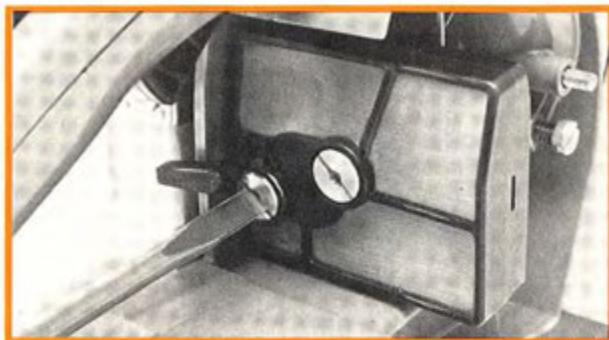

Carburetor

- 1 High speed adjustment screw
- 2 Low speed adjustment screw
- 3 Idle speed adjustment screw

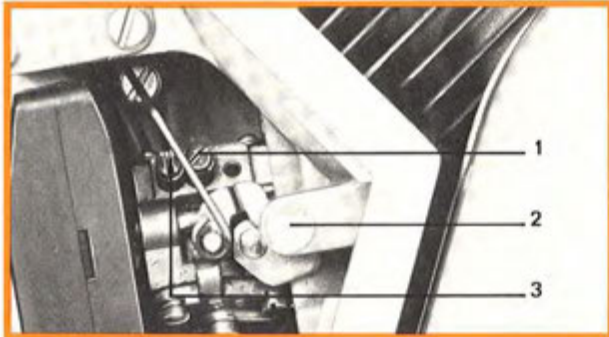

The carburetor is adjusted at the factory to achieve low fuel consumption and optimum engine power under local atmospheric conditions.

The standard carburetor setting will have to be changed if the machine is used at higher altitudes (mountains) or near sea level. This correction is made at the high and low speed adjustment screws and the idle speed screw.

The high and low speed adjustment screws should be carefully screwed down onto their seats before making the basic adjustment — only intended as a guide for fine adjustment. Then make the following adjustments:

- High speed adjustment screw H: Open $1\frac{1}{4}$ turns
- Low speed adjustment screw L: Open $1\frac{1}{4}$ turns

These adjustments screws must not be interchanged.

Carry out carburetor adjustment only when the engine is warm and after cleaning the air filter.

Notes for fine adjustment of carburetor

Engine stops while idling:

Turn idle speed adjustment screw slightly clockwise while the engine is running (chain must not turn).

Chain turns while engine is idling:

Turn idle speed adjustment screw slightly counter-clockwise.

Engine runs erratically at idle speed:

Adjust at low speed adjustment screw. Turn clockwise for leaner mixture or counter-clockwise for richer mixture.

Caution: The setting of the high-speed adjustment screw affects the engine's maximum off-load speed. If it is set too lean (adjustment screw turned too far clockwise), the maximum permissible engine speed of 12000 r.p.m. will be exceeded. This can result in engine damage brought about by insufficient lubrication in particular.

Apart from minor readjustments, you should not attempt carburetor adjustments or repairs yourself. Entrust such work to STIHL Service. In most areas you will find STIHL Service Shops with trained specialists and the tools necessary for expert servicing.

Rewind Starter

Component parts of starter device

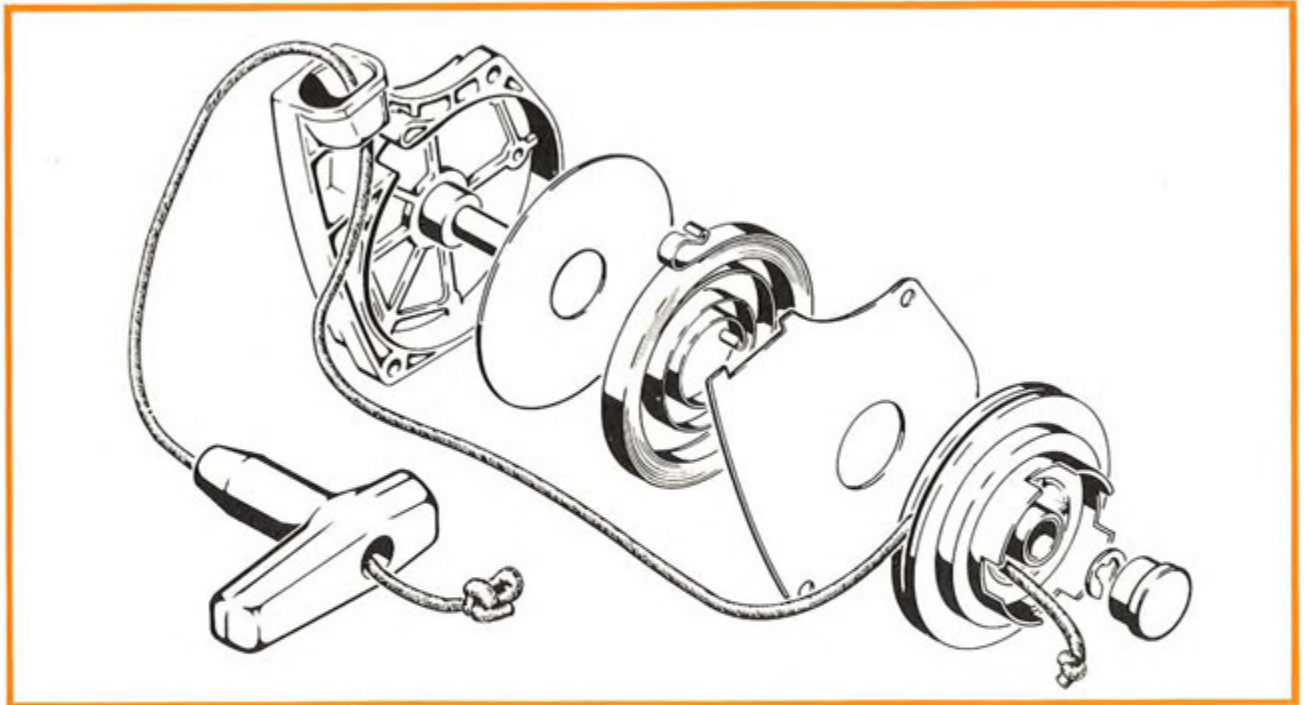

The rewind starter is very rugged but, of course, normal wear cannot be avoided.

To repair the rewind starter remove starter cover from fan housing.

If starter rope is broken:

Remove protecting cap and pry retaining washer off the shaft of the rewind starter with a screwdriver.

Take rope rotor from the shaft, remove the remaining piece of cord and thread new cord into rope rotor. The correct length of the rope is 36" (90 cm). Secure the rope end in the rope rotor with a single knot and the other end in the starter grip with a double knot.

Oil bore of rope rotor slightly, place rotor onto shaft and make sure that rewind spring is hooked into the pin. Secure the rope rotor, with a retaining washer, reinstall protecting cap and tension rope as described below.

If rewind spring is broken:

A broken rewind spring can only be replaced by a new one. The spare spring is secured with a wire loop. Remove wire loop when pushing spring into pulley.

Remove rope pulley as described above and remove the shim. Take broken rewind spring out of starter cover and insert the new one.

Check to be sure that the outer loop of the rewind spring is hooked into the pin in the starter cover. If rewind spring is not hooked into this pin the starter rope cannot be tensioned.

If rewind spring should have uncoiled from starter cover, coil it into cover in clockwise direction, starting with the outer loop and ending with the inner loop.

Re-assemble by reversing disassembly sequence.

Tensioning of rewind spring:

After you have knotted the starter rope and installed the new rewind spring, wind rope completely on rope rotor. Then pull loop of cord 12"–16" (30–40 cm) up between the bore of the starter cover and the rope rotor and wind rope two more turns onto the pulley. In this way the rope pulley has got the necessary pretension.

Top: Rewind spring ready for installation
Bottom: Rewind spring hooked into lug

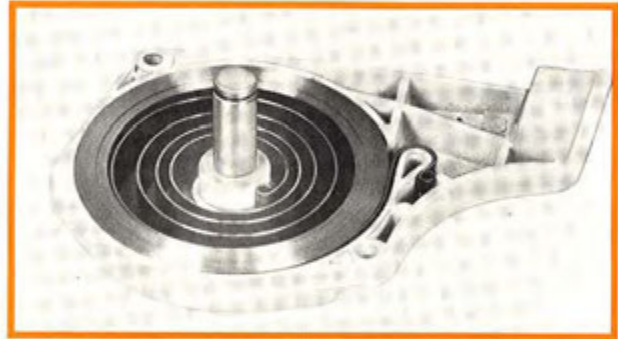

The rewind spring is correctly tensioned if starter grip is pulled up against the housing and doesn't hang down and if pulley can still be turned one turn before reaching maximum spring tension when the cord is pulled out fully.

Excessive spring tension will cause breakage of the spring.

Maintenance Chart

		before starting work	after finishing work or daily	after each refueling stop	weekly	monthly	if faulty	if damaged	as required	see page:
Complete machine	Visual inspection (condition, leaks)	x		x						
	clean		x							
Throttle trigger, safety throttle lock, stop switch	Check operation	x		x						
Chain brake	Check operation	x		x						22
	Clean				x				x	
Filter in fuel tank	Clean wire filter					x				
	Replace felt									
Fuel tank	Clean					x				
Chain oil tank	Clean					x				
Chain lubrication	Check	x								26, 27
Saw chain	Inspect, also check sharpness	x		x						
	Check chain tension	x		x						28
	Sharpen								x	37
Guide bar	Inspect (wear, damage)	x								27
	Clean and turn over				x		x			
	Lubricate sprocket nose		x							27
	Deburr				x					
	Replace							x	x	
Chain sprocket	Check				x					28
Air filter	Clean	x					x			30
	Replace							x		30
Cooling inlets	Clean		x							
Cylinder fins	Clean					x				
Carburetor	Check idle adjustment – chain must not turn	x		x						31
	Readjust idle								x	31
Spark plug	Readjust electrode gap						x			
All accessible screws and nuts (not adjusting screws)	Retighten								x	
	Inspect				x					
Rubber vibration buffers	To be replaced only by STIHL Dealer							x		
Spark arrestor screen	Inspect	x								
	Clean or replace							x		
Chain catching bolt	Check	x								
	Replace							x		

Specifications

Versions available

1. 031 AV: breaker controlled magneto ignition
2. 031 AVE: electronic magneto ignition
3. 031 AVEW: as 031 AVE but with electrically-heated handles
4. 031 AVQ: as 031 AV but with chain brake
5. 031 AVEQ: as 031 AVE but with chain brake
6. 031 AVEQW: as 031 AVEQ but with electrically-heated handles

Engine

STIHL single cylinder two-stroke engine
Displacement: 49 cm³ (3.02 cu. in)
Bore: 44 mm (1.73 in)
Stroke: 32 mm (1.26 in)

Ignition System on AV and AVQ

Type: Breaker controlled magneto ignition
Ignition timing: 2.0–2.3 mm
(0.08–0.09 in) before T.D.C.
Breaker point gap: 0.35–0.4 mm
(0.014–0.016 in)

AVE, AVEW, AVEQ and AVEQW

Type: Electronic (breakerless) magneto ignition
Ignition timing: 2.5 mm (0.1 in)
before T.D.C. at 8000 r.p.m.

All versions

Spark plug (suppressed): Bosch WSR 6 F or
Champion RCJ 6 Y
Heat range 175
Electrode gap 0.5 mm (0.02 in)
Spark plug thread: M 14 x 1.25, 9.5 mm
(0.37 in) long

Fuel System

Carburetor: All position diaphragm carburetor with integral fuel pump
Air filter: Flat two-piece wire mesh filter
Fuel capacity: 0.54 l (1.14 US pt)
Fuel mixture: Regular grade gasoline and branded two-stroke engine oil
Mix ratio 1:40 with STIHL two-stroke engine oil; or 1:25 with other branded two-stroke engine oils

Cutting Attachment

Guide bars: Duromatic 40, 45 and 50 cm
(16, 18 and 20 in)
Rollomatic 32, 37, 40 and 45 cm
(13, 15, 16 and 18 in)
Oilomatic chain: 8.25 mm (0.325") and 9.32 mm
(3/8") Rapid-Standard,
-Micro and -Super.
Also available as S-type chain
Chain sprocket: 8-tooth for 0.325" pitch
7-tooth for 3/8" pitch
Chain lubrication: Fully automatic oil pump with manual feed rate control
Oil tank capacity: 0.3 l (0.6 US pt)

Weight

031 AV with 32 cm (13 in)
bar and chain: 6.6 kg (14.6 lb)

Sharpening and Maintenance of Saw Chain

Description of chains

STIHL saw chains are 3-link chains and all versions are assembled in the same basic pattern. The illustration on the right shows the component parts of a saw chain. Every chain manufactured by STIHL features the exclusive Oilomatic system. Apart from the three basic types (Rapid, Picco and Topic), there are three different versions whose names denote the cutter shape, i. e. chipper tooth = Standard, semi-chisel = Micro and full chisel = Super. Oilomatic Rapid chains are also available in standard and safety versions.

The main size measurement on a saw chain is the pitch. It is determined by measuring the distance from the center of one rivet to the center of the next rivet but one and dividing the measurement by two. The result is the pitch which, in accordance with international custom, is specified in inch ($\frac{3}{8}$ " = 9.32 mm).

Like any other cutting tool, the saw chain is subject to normal wear. A properly sharpened chain will eat into the wood and require very little effort on the part of the operator. For this reason alone you should never attempt to cut with a dull or damaged chain.

There are a few crucial angles which must be maintained in order to obtain good results when sharpening a chain. They are explained below.

Filing angle

The filing angle for Rapid-Standard and Rapid-Micro chains is 35°; these chains are initially sharpened to this angle before leaving the factory. However, if the chain is used primarily for cutting hardwood or frozen timber it is best to sharpen it to an angle of 30°. On the other hand, the filing angle for Rapid-Super and Topic-Super is always 30°.

Top: Component parts of Oilomatic Rapid chain
Bottom: Measuring chain pitch

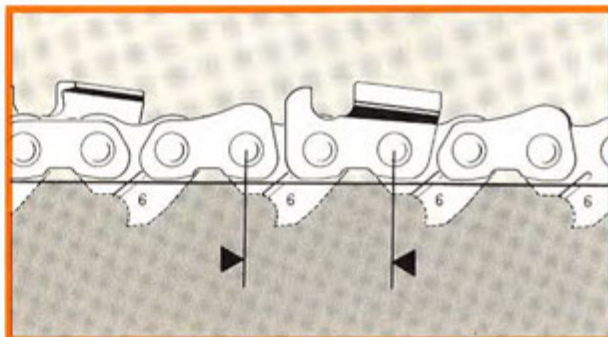
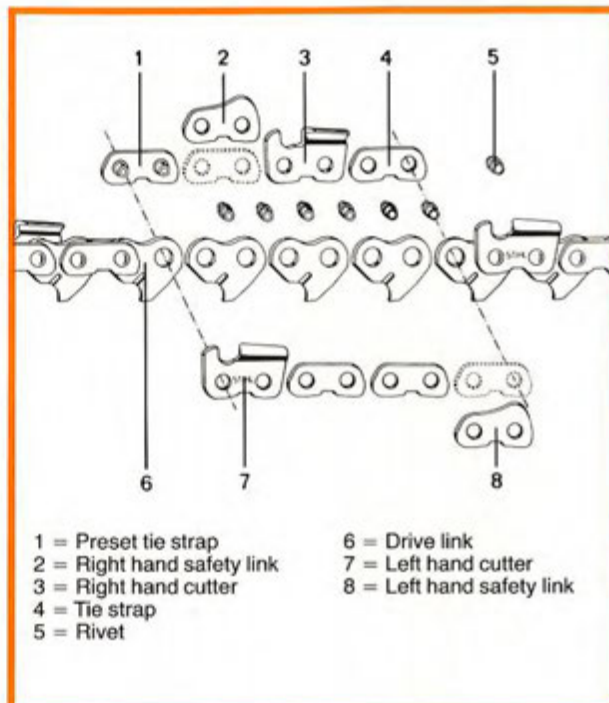

Top: Filing angle
 Center: 1-3 = Side plate angle
 4 = Top plate cutting angle
 Bottom: Table of file diameters

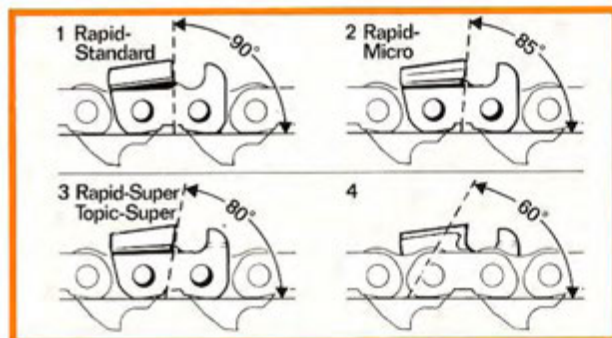
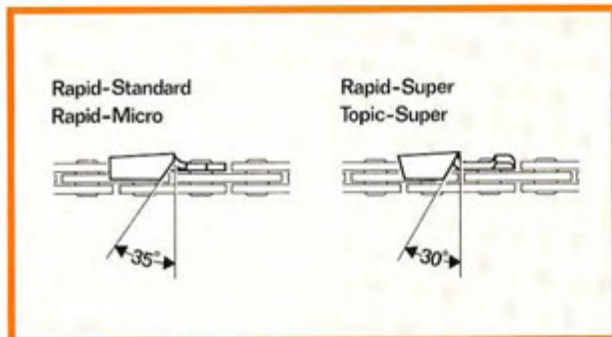

Chain pitch	File dia.	File No.
.325" (8.25 mm)	4.8 mm	0811 411 8088
3/8" (9.32 mm)*	5.5 mm	0811 411 8108
3/8" (Topic)	4.5 mm	6814 242 3396
.404" (10.26 mm)*	5.5 mm	0811 411 8108
1/2" (12.7 mm)	6.3 mm	0811 411 8118

* The 4.8 mm dia. round file must be used when the top plate has been filed back half-way.

It is essential to insure that the filing angle is kept exactly the same on all cutters. Irregular angles will cause the chain to run roughly and unevenly as well as increase the rate of wear and result in chain breakage. When sharpening by hand **always file from the inside to the outside of the cutting edge.**

Side plate angle

The upright cutting edge just below the top plate is known as the side plate cutting edge. The side plate angle is, therefore, the angle between the side plate cutting edge and the horizontal line formed by the cutter toe and heel. The specified side plate angles are 90° for Rapid-Standard, 85° for Rapid-Micro and 80° for Rapid-Super and Topic-Super chain. These angles are obtained automatically if a file holder is used with the correct file and the file is held correctly during sharpening.

Top plate cutting angle

The top plate cutting angle is 60° on all chains. It is also obtained automatically when the chain is sharpened carefully with a file holder or another STIHL sharpening tool.

Sharpening

Only special saw chain files may be used for sharpening and they must match the chain pitch. The shape and cut of machinists' files makes them unsuitable for saw chain. The special chain file should be used with a file holder or a filing tool.

All cutters must be filed to the same length. As the top plate slopes downward to the rear (clearance angle) the cutter

Top: File position for Rapid-Standard
Bottom: Sharpening with file holder

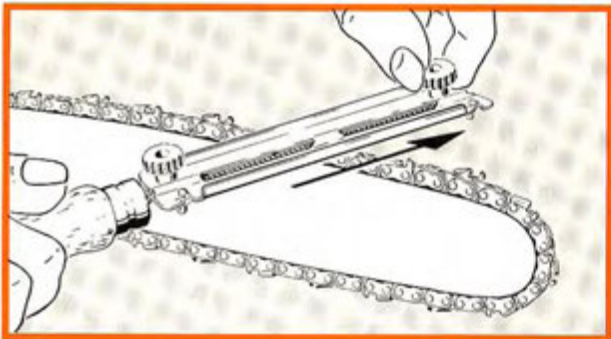
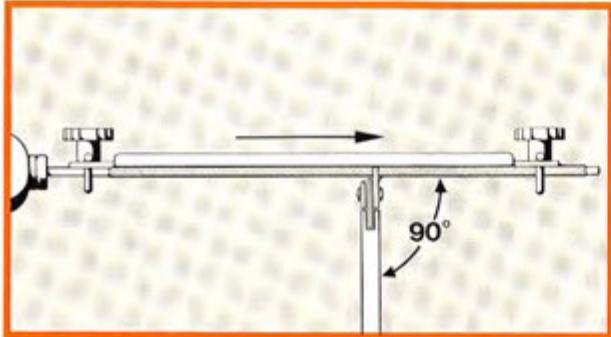

heights will be uneven if the cutter lengths are different. If the cutters are not all the same height the chain will run roughly and eventually break.

As it is very important to achieve uniform cutter lengths it is best to measure them with a slide caliper. Find and sharpen the shortest cutter first and then use it as a master for all the others, i.e. all cutters must be filed back to the same length as the master cutter. Sharpen all the cutters on one side of the chain first and then repeat the procedure on the other side.

File position for Rapid-Micro, Rapid-Super and Topic-Super

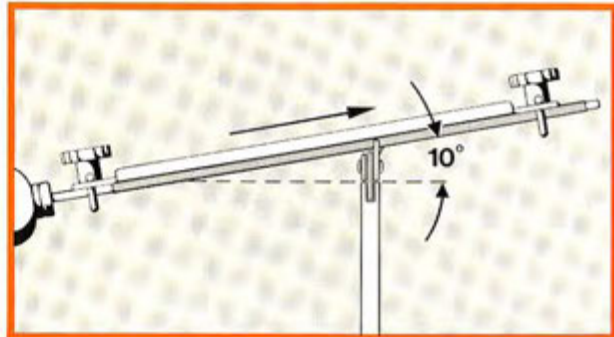

The file must be held level for **Rapid-Standard chain** so that it is at 90° to the perpendicular faces of the chain links.

On **Rapid-Micro, Rapid-Super and Topic-Super chains** the file and file holder must be guided so that the handle is 10° lower than the tip of the file, i.e. in this case the file must run upward at an angle of 10° to the horizontal. A file holder must always be used for manual sharpening of Rapid-Super and Topic-Super chains.

File evenly and steadily and note that the file **only sharpens on the forward stroke**. The file must be lifted off the cutter on the backstroke. Make sure that you do not touch the tie straps and drive links. Burrs on the cutting edge can be removed with a piece of hardwood.

Rotate the file at frequent intervals in order to prevent it becoming worn unevenly.

Important: Sharpen the chain frequently and take away as little material as possible. Two or three strokes of the file are usually sufficient to keep the chain sharp.

A STIHL electric sharpener greatly simplifies chain sharpening.

Depth gauges

The depth gauge determines the height at which the cutter enters the wood and thus the thickness of the chip removed. The cutting capacity and life of a saw chain are therefore influenced by the distance between the depth gauge and the cutting edge, i. e. the depth gauge setting. This setting varies according to chain pitch and must be checked with the appropriate filing gauge.

The best cutting results are obtained with the settings listed in the table on the right. However, the depth gauge setting may be increased by 0.2 mm for cutting softwood in mild weather conditions.

As the cutter is sharpened the depth gauge setting is reduced. This means the height of the depth gauge must be checked and lowered if necessary. If the depth gauge projects from the filing gauge, it must be filed down level with the gauge. On Rapid chain the depth gauge should also be rounded off to its original shape.

General chain maintenance

Chain maintenance begins as soon as the chain is fitted on the bar and sprocket. The essential points are **correct chain tension and ample lubrication**. See also "Cutting Attachment".

Clean the chain thoroughly in gasoline after sharpening in order to remove filings or grinding dust. Then lubricate the chain by immersing it in an oil bath. If the chain has not been used for an extended period, clean it with a brush and immerse it in an oil-paraffin bath.

Top: Table of recommended depth gauge settings
Center: Depth gauge setting
Bottom: Filing down depth gauge (Rapid chain)

Chain pitch	Setting	Filing gauge
.325" (8.25 mm)	0.65 mm	1110 893 4000
3/8" (9.32 mm)	0.65 mm	1110 893 4000
.404" (10.26 mm)	0.8 mm	1106 893 4000
1/2" (12.7 mm)	0.8 mm	1106 893 4000
090 G chain saw		
1/2" (12.7 mm)	1.2 mm	1106 893 4010

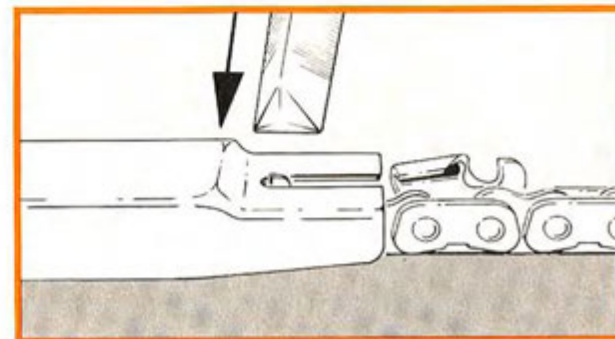
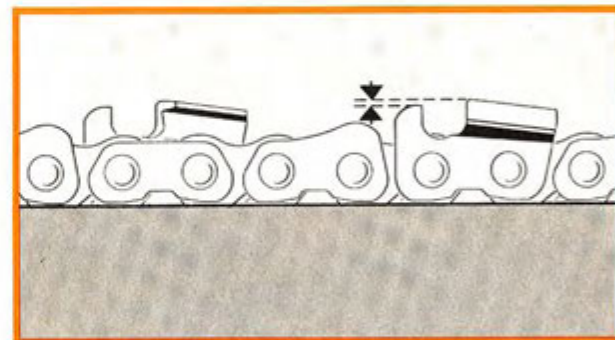

Carefully examine chain for cracks in the links or damaged rivets while you are sharpening and cleaning it. Any damaged or worn parts must be replaced. The new parts must be reworked to match the shape and size of the original parts.

Chain breaking and riveting is best carried out with the STIHL rivet spinner.

Tools for chain maintenance

The **filing grid** has reference marks for the filing angle and is attached to the guide bar by means of a magnet.

File holders, which also have reference marks for the filing angle, simplify chain sharpening.

If you use the **STIHL-“Feilgenau”**, the **STIHL HOS** and **USG electric sharpeners** or the **STIHL rivet spinner**, always follow the separate operating instructions supplied with the tool.

Top: Table of file holder order numbers
Bottom: STIHL file holder

Chain pitch	Chain	File holder
.325" (8.25 mm)	Rapid-Micro	5605 750 4325
.325" (8.25 mm)	Rapid-Super	5605 750 4340
3/8" (9.32 mm)	Rapid-Standard	5605 750 4330
3/8" (9.32 mm)	Rapid-Micro	5605 750 4330
3/8" (9.32 mm)	Rapid-Super	5605 750 4335
3/8" (9.32 mm)	Topic-Super	5605 750 4345
.404" (10.26 mm)	Rapid-Standard	5605 750 4330
.404" (10.26 mm)	Rapid-Micro	5605 750 4330
.404" (10.26 mm)	Rapid-Super	5605 750 4335

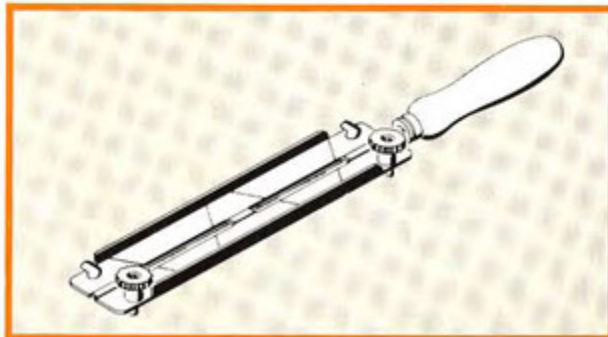

- 1 = for Micro and Picco
- 2 = for Standard
- 3 = for Super
- 4 = Standard, Micro and Picco filing angle

- 5 = Super filing angle
- 6 = Depth gauge setting
- 7 = Groove cleaner and scale for groove depth

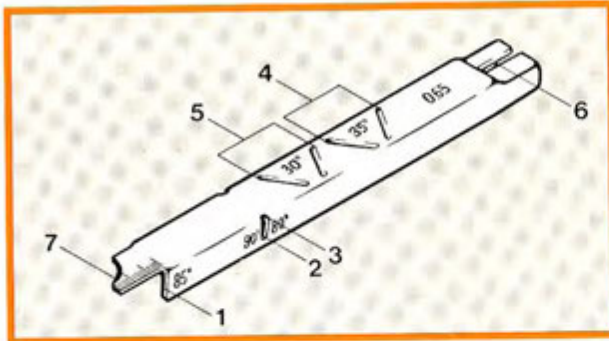

The **filing gauge** is a universal tool for checking the filing and side plate angles as well as the depth gauge setting and cutter length. It can also be used for cleaning the groove and oil inlet hole on the guide bar and measuring the groove depth.

- 1 = Sprocket pitch
- 2 = Chain pitch
- 3 = Drive link gauge
- 4 = Groove width

- 5 = Lug for cleaning bar groove and oil inlet hole

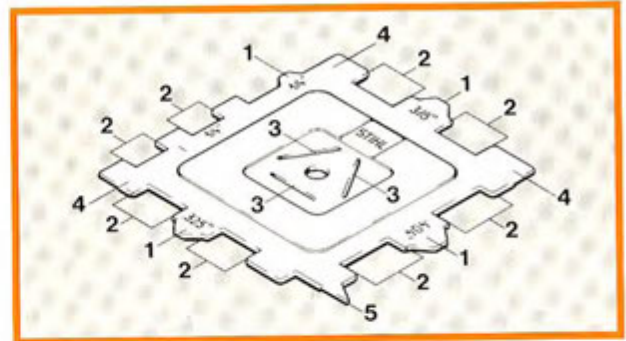

The **reference gauge 0000 893 4105** is used for measuring the pitch of the chain and sprocket as well as the drive link gauge on any chain. It is also provided with a lug for cleaning the bar groove and oil inlet hole.

Continuation of Important Safety Precautions

14. Keep the handles dry, clean and free of oil or fuel mixture.
15. Operate the chain saw only in well ventilated areas.
16. Do not operate a chain saw in a tree unless specifically trained to do so.
17. **All** chain saw service, other than the items listed in the Owner's Manual maintenance instructions, should be performed by competent chain saw service personnel. (E.g., if improper tools are used to remove the flywheel, or if an improper tool is used to hold the flywheel in order to remove the clutch, structural damage to the flywheel could occur which could subsequently cause the flywheel to burst).
18. Avoid kickback. Kickback is the upward motion of the guide bar which occurs when the saw chain at the nose of the guide bar contacts an object. Kickback can lead to dangerous loss of control of the chain saw.

To avoid kickback:

- Hold the chain saw firmly with both hands.
 - Don't overreach.
 - Don't let the nose of the guide bar contact a log, branch, ground or any other obstruction.
 - Cut at high engine speeds.
 - Don't cut above shoulder height.
 - Follow manufacturer's sharpening and maintenance instructions for the saw chain.
 - Use devices such as low kickback chain, which may help to reduce the hazards associated with kickback.
19. When transporting your chain saw, use the appropriate guide bar scabbard.
 20. Narrow nose bars and low kickback chains are designed to reduce the risk of kickback injury. Ask your dealer about these devices.

englisch/english

Chainsaw Safety Manual

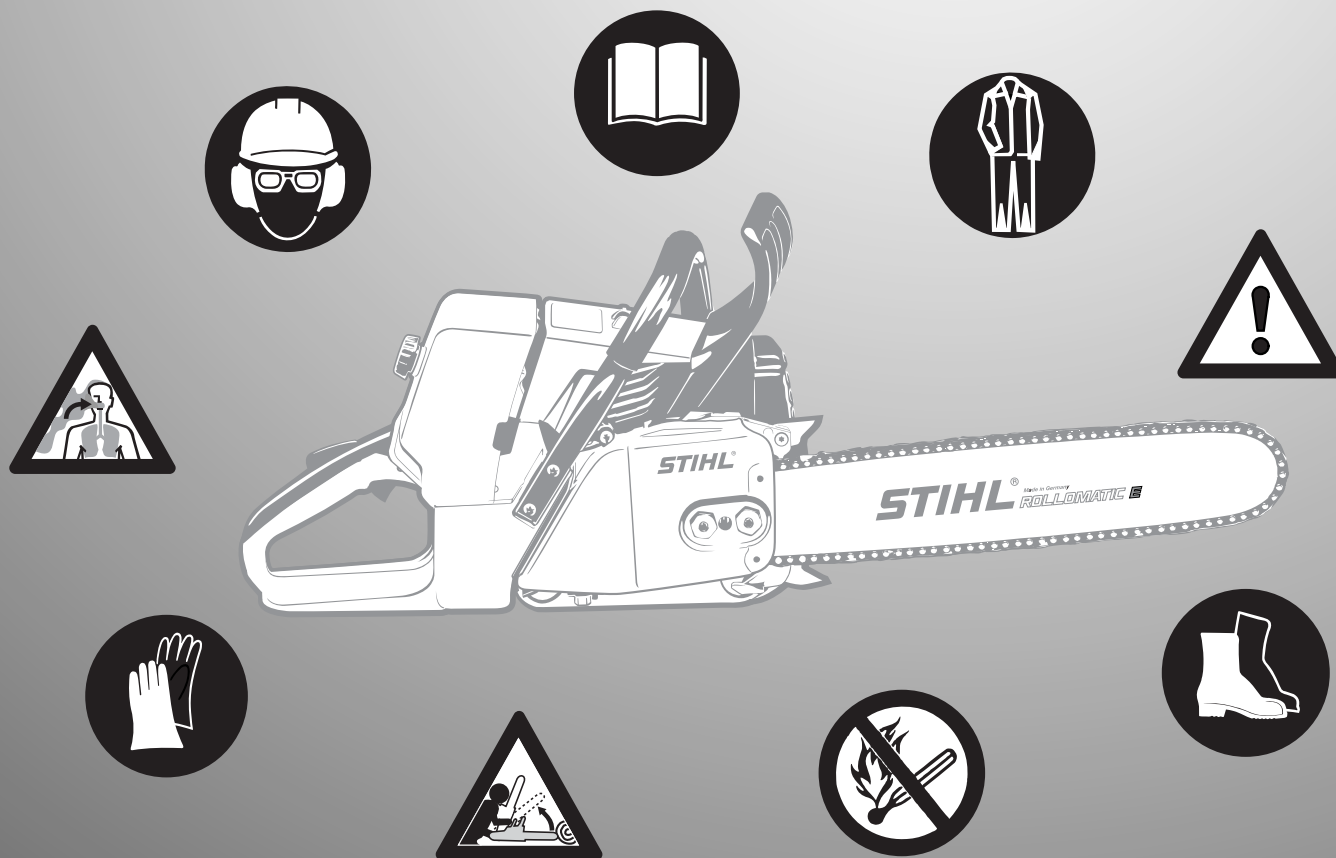

Contents

Some Important Safety Precautions for Chain Saw Users	2
Safety Precautions	4
Maintenance Chart	26
Main Parts of the Saw	28

This manual contains the safety precautions and recommended cutting techniques outlined in STIHL chainsaw Owner's Manuals. Even if you are an experienced chainsaw user, it is in your own interests to familiarize yourself with the latest rules and regulations regarding safe use of your chainsaw.

Please note that the illustrations on pages 28 and 29 show the chainsaws STIHL MS 210, 230, 250.

Other chainsaw models may have different parts and controls. You should therefore always refer to the Owner's Manual of your particular saw model.

Warning!

Because a chainsaw is a high-speed wood-cutting tool, some special safety precautions must be observed as with any other power saw to reduce the risk of personal injury. Careless or improper use may cause serious or even fatal injury. Read and follow all safety precautions in current Owner's Manual or Safety Manual. Always use two hands to operate the chainsaw.

Warning!

Avoid contact of bar tip with any object. This can cause the guide bar to kick suddenly up and back, which may result in serious or fatal injury. To reduce the risk of kickback injury STIHL recommends the use of STIHL green labeled reduced kickback bars and low kickback chains and a STIHL Quickstop chain brake. Contact your STIHL dealer or the STIHL distributor for your area if you do not understand any of the instructions in this manual.

Some Important Safety Precautions for Chain Saw Users

A. A Summary of Warnings on kickback and other Selected Risks – Taken Primarily from ANSI B 175.1 (See also “Safety Precautions“ section of this Owner’s Manual)

Warning!

Kickback may occur when the nose or tip of the guide bar touches an object, or when the wood closes in and pinches the saw chain in the cut. Tip contact in some cases may cause a lightning fast reverse reaction, kicking the guide bar up and back towards the operator. Pinching the saw chain along the top of the guide bar may push the guide bar rapidly back towards the operator. Either of these reactions may cause you to lose control of the saw which could result in serious personal injury.

Section 5.11 of ANSI B 175.1-2000 sets certain performance and design criteria related to chainsaw kickback. STIHL has developed a color code system using green and yellow to help you select a powerhead, bar and chain combination that complies with the kickback requirements of the ANSI Standard. See the sections entitled "Safety Precautions" and "Specifications" of this manual.

Do not rely exclusively upon the safety devices built into your saw. As a chainsaw user, you should take several steps to keep your cutting jobs free from accident or injury.

1. With a basic understanding of kickback, you can reduce or eliminate the element of surprise. Sudden surprise contributes to accidents.
2. Keep a good firm grip on the saw with both hands, the right hand on the rear handle, and the left hand on the front handle, when the engine is running. Use a firm grip with thumbs and fingers encircling the chainsaw handles. A firm grip will help you reduce kickback and maintain control of the saw. Don't let go.
3. Make sure the area in which you are cutting is free from obstructions. Do not let the nose of the guide bar contact a log, branch, or any other obstruction that could be hit while you are operating the saw.
4. Cut at high engine speeds.
5. Do not overreach or cut above shoulder height.

6. Follow manufacturer's sharpening and maintenance instructions for the saw chain.
7. Only use replacement bars and chains specified by the manufacturer or the equivalent.
8. Reduced kickback bars and low kickback chains are designed to reduce the risk of kickback injury. Ask your STIHL dealer about these devices.

B. Other Safety Precautions

Warning!

1. Do **not** operate a chainsaw with one hand! Serious injury to the operator, helpers, bystanders, or any combination of these persons may result from one-handed operation. A chainsaw is intended to be used with two hands.
2. Do not operate a chainsaw when you are fatigued.
3. Use safety footwear; snug-fitting clothing; protective gloves; and eye, hearing, and head protection devices.

4. Use caution when handling fuel. Move the chainsaw at least 10 feet (3 m) from the fueling point before starting the engine.
 5. Do not allow other persons to be near the chainsaw when starting or cutting with the chainsaw. Keep bystanders and animals out of the work area.
 6. Do not start cutting until you have a clear work area, secure footing, and a planned retreat path from the falling tree.
 7. Keep all parts of your body away from the saw chain when the engine is running.
 8. Before you start the engine, make sure that the saw chain is not contacting anything.
 9. Carry the chainsaw with the engine stopped, the guide bar and saw chain to the rear, and the muffler away from your body.
 10. Do not operate a chainsaw that is damaged, improperly adjusted, or not completely and securely assembled. Be sure that the saw chain stops moving when the throttle trigger is released.
 11. Shut off the engine before setting the chainsaw down.
 12. Use extreme caution when cutting small size brush and saplings because slender material may catch the saw chain and be whipped toward you or pull you off balance.
 13. When cutting a limb that is under tension be alert for springback so that you will not be struck when the tension in the wood fibers is released.
 14. Keep the handles dry, clean, and free of oil or fuel mixture.
 15. Operate the chainsaw only in well-ventilated areas.
 16. Do not operate a chainsaw in a tree unless you have been specifically trained to do so.
 17. All chainsaw service, other than the items listed in the Owner's Manual maintenance instructions, should be performed by competent chainsaw service personnel. (For example, if improper tools are used to remove the flywheel or if an improper tool is used to hold the flywheel in order to remove the clutch, structural damage to the flywheel could occur and could subsequently cause the flywheel to burst).
 18. When transporting your chainsaw, use the appropriate chain guard (scabbard).
- Other important safety precautions are contained in the body of the Owner's Manual especially in the General Safety Precautions.
- Note:**
- When using a chainsaw for logging purposes, refer to the Code of Federal Regulations, Parts 1910 and 1928.

Safety Precautions



The use of any chainsaw may be hazardous. The saw chain has many sharp cutters. If the cutters contact your flesh, they will cut you, even if the chain is not moving. At full throttle, the chain speed can reach 45 mph (20 m/s). It is important that you read, fully understand and observe the following safety precautions and warnings. Read the Owner's Manual and the Safety Precautions periodically. Pay special attention to the section on reactive forces.



Warning!
Reactive forces, including kickback, can be dangerous. Careless or improper use of any chainsaw may cause serious or fatal injury.

All safety precautions that are generally observed when working with an axe or a hand saw also apply to the operation of chainsaws. However, because a chainsaw is a high-speed, fast-cutting power tool, special safety precautions must be observed to reduce the risk of personal injury.

Have your STIHL dealer show you how to operate your chainsaw. Observe all applicable local safety regulations, standards and ordinances.



Warning!
Minors should never be allowed to use a chainsaw. Bystanders, especially children, and animals should not be allowed in the area where a chainsaw is in use. Never let the saw run unattended. Store it in a locked place away from children and empty the fuel tank before storing for longer than a few days.



Do not lend or rent your chainsaw without the Owner's Manual. Be sure that anyone using your saw reads and understands the information contained in this manual.

These safety precautions and warnings apply to the use of all STIHL chainsaws. Different models may have different parts and controls. See the appropriate section of your Owner's Manual for a description of the controls and function of the parts of your model saw.

Safe use of a chainsaw involves

1. the operator
2. the saw
3. the use of the saw.

THE OPERATOR

Physical Condition

You must be in good physical condition and mental health and not under the influence of any substance (drugs, alcohol) which might impair vision, dexterity or judgement.

Do not operate a chainsaw when you are fatigued. Be alert - If you get tired while operating your chainsaw, take a break. Tiredness may result in loss of control. Working with any chainsaw can be strenuous. If you have any condition that might be aggravated by strenuous work, check with your doctor before operating a chainsaw.



Warning!
Prolonged use of chainsaws (or other machines) exposing the operator to vibrations may produce whitefinger disease (Raynaud's phenomenon) or carpal tunnel syndrome.

These conditions reduce the hand's ability to feel and regulate temperature, produce numbness and burning sensations and may cause nerve and circulation damage and tissue necrosis.

All factors which contribute to whitefinger disease are not known, but cold weather, smoking and diseases or physical conditions that affect blood vessels and blood transport, as well as high vibration levels and long periods of exposure to vibration are mentioned as factors in the development of whitefinger disease. In order to reduce the risk of whitefinger disease and carpal tunnel syndrome, please note the following:

- Many STIHL models are available with an anti-vibration (AV) system designed to reduce the transmission of vibrations created by the engine and cutting attachment to the operator's hands. An AV system is recommended for those persons using chainsaws on a regular or sustained basis.
- Wear gloves and keep your hands warm. Heated handles, which are available on most STIHL powerheads, are recommended for cold weather use.

- Keep the saw chain sharp and the saw, including the AV system, well maintained. A dull chain will increase cutting time, and pressing a dull chain through wood will increase the vibrations transmitted to your hands. A saw with loose components or with damaged or worn AV buffers will also tend to have higher vibration levels.
- Maintain a firm grip at all times, but do not squeeze the handles with constant, excessive pressures. Take frequent breaks.

All the above mentioned precautions do not guarantee that you will not sustain whitefinger disease or carpal tunnel syndrome. Therefore, continual and regular users should monitor closely the condition of their hands and fingers. If any of the above symptoms appear, seek medical advice immediately.

Warning!

The ignition system of your unit produces an electromagnetic field of a very low intensity. This field may interfere with some pacemakers. To reduce the risk of serious or fatal injury, persons with pacemaker should consult their physician and the pacemaker manufacturer before operating this tool.

Proper Clothing

Warning!

To reduce the risk of injury, the operator should wear proper protective apparel.



Clothing must be sturdy and snug-fitting, but allow complete freedom of movement. Avoid loose-fitting jackets, scarfs, neckties, jewelry, flared or cuffed pants, unconfined long hair or anything that could become entangled with the saw or brush. Wear overalls or jeans with a reinforced cut retardant insert or cut retardant chaps.



Protect your hands with gloves when handling saw and saw chain. Heavy-duty, nonslip gloves improve your grip and protect your hands.



Good footing is most important in chainsaw work. Wear sturdy boots with nonslip soles. Steel-toed safety boots are recommended.

Never operate a chainsaw unless wearing goggles or properly fitted safety glasses with adequate top and side protection complying with your national standard.



Wear an approved safety hard hat to protect your head. Chainsaw noise may damage your hearing. Always wear sound barriers (ear plugs or ear muffers) to protect your hearing. Continual and regular users should have their hearing checked regularly.

THE SAW

Parts of the chainsaw; for illustrations and definitions of the parts see the chapter on "Main Parts of Saw".

Warning!

Never modify a chainsaw in any way. Only attachments and parts supplied by STIHL or expressly approved by STIHL for use with the specific STIHL saw models are authorized. Although certain unauthorized attachments are usable with the STIHL powerhead, their use may, in fact, be extremely dangerous.

THE USE OF THE SAW

Transporting the chainsaw

Warning!

Always stop the engine before putting a chainsaw down or carrying it. Carrying a chainsaw with the engine running is extremely dangerous.

Accidental acceleration of the engine can cause the chain to rotate. During operation, the powerhead muffler and the material around it reach extremely high temperatures. Avoid touching the hot muffler, you could receive serious burns.

By hand: When carrying your saw by hand, the engine must be stopped and the saw must be in the proper position.

Grip the front handle and place the muffler away from the body.

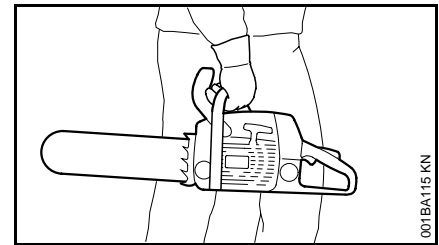

The chain guard (scabbard) should be over the chain and the guide bar, which should point backwards. When carrying your saw, the bar should be behind you.

By vehicle: When transporting in a vehicle, keep chain and bar covered with the chain guard. Properly secure your saw to prevent turnover, fuel spillage and damage to the saw or vehicle.

Preparation for the use of the saw

Take off the chain guard and inspect for safety in operation. For assembly, follow the procedure described in the chapter "Mounting the Bar and Chain" of your Owner's Manual.

STIHL Oilomatic chain, guide bar and sprocket must match each other in gauge and pitch.

Before replacing any bar and chain, see the sections on "Specifications", "Kickback" and the "ANSI B 175.1-2000 chainsaw kickback standard" in this manual.

⚠ Warning!

Proper tension of the chain is extremely important. In order to avoid improper setting, the tensioning procedure must be followed as described in your manual. Always make sure the hexagonal nut(s) for the sprocket cover is (are) tightened securely after tensioning the chain. Never start the saw with the sprocket cover loose. Check chain tension once more after having tightened the nut(s) and thereafter at regular intervals (whenever the saw is shut off). If the chain becomes loose while cutting, shut off the engine and then tighten. Never try to adjust the chain while the engine is running!

Fueling

Your STIHL chainsaw uses an oil-gasoline mixture for fuel (see chapter "Fuel" of your Owner's Manual).

⚠ Warning!

Gasoline is an extremely flammable fuel. If spilled or ignited by a spark or other ignition source, it can cause fire and serious burn injury or property damage. Use extreme caution when handling gasoline or fuel mix.



Do not smoke or bring any fire or flame near the fuel or the chainsaw. Note that combustible fuel vapors may be vented from the fuel system.

Fueling Instructions**⚠ Warning!**

Fuel your chainsaw in well-ventilated areas, outdoors only. Always shut off the engine and allow it to cool before refueling. Gasoline vapor pressure may build up inside the gas tank depending on the fuel used, the weather conditions, and the venting system of the tank. In order to reduce the risk of burns or other personal injury from escaping gas vapor and fumes, remove the fuel filler cap on the STIHL product carefully so as to allow any pressure build-up in the tank to release slowly. Never remove fuel filler cap while engine is running.

Select bare ground for fueling and move at least 10 feet (3 m) from fueling spot before starting the engine. Wipe off any spilled fuel before starting your saw, and check for leakage.

⚠ Warning!

Check for fuel leakage while refueling and during operation. If fuel or oil leakage is found, do not start or run the engine until leak is fixed and spilled fuel has been wiped away. Take care not to get fuel on your clothing. If this happens, change your clothing immediately. Different models may have different fuel caps.

Cap with Grip**⚠ Warning!**

In order to reduce the risk of fuel spillage and fire from an improperly tightened fuel cap, correctly position and tighten the fuel cap in the fuel tank opening.



To do this with this STIHL cap, raise the grip on the top of the cap until it is upright at a 90° angle.

Insert the cap in the fuel tank opening with the triangular marks on the grip of the cap and on the fuel tank opening lining up. Using the grip, turn the cap firmly clockwise as far as it will go (approx. a quarter turn).



Fold the grip flush with the top of the cap. If the grip does not lie completely flush with the cap and the detent on the grip does not fit in the

corresponding recess in the filler neck, the cap is not properly seated and tightened and you must repeat the above steps.

Slotted Cap



Unit vibrations can cause an improperly tightened fuel filler cap to loosen or come off and spill quantities of fuel. In order to reduce the risk of fuel spillage and fire, tighten fuel filler cap by hand with as much force as possible.



The screwdriver end of the STIHL combination wrench or other similar tool can be used as an aid in tightening slotted fuel filler caps.

See "Fueling" chapter in your Owner's Manual.

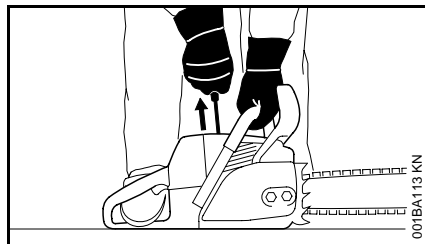

Starting

The chain brake must be engaged when starting the saw.



Your chainsaw is a one-person saw. Do not allow other persons to be near the running chainsaw. Start and operate your saw without assistance. For specific starting instructions, see the appropriate section of the Owner's Manual. Proper starting methods reduce the risk of injury. Do not drop start. This method is very dangerous because you may lose control of the saw.

There are two recommended methods for starting your chainsaw.

With the **first** recommended **method**, the chainsaw is started on the ground. Make sure the chain brake is engaged (see "Chain Brake" chapter in your Owner's Manual) and place the chainsaw on firm ground or other solid surface in an open area. Maintain good balance and secure footing.

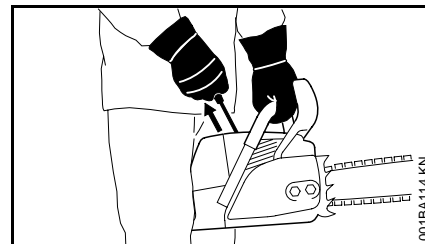

Grip the front handlebar of the saw firmly with your left hand and press down. For saws with a rear handle level with the ground, put the toe of your right foot into the rear handle and press down. With your right hand pull out the starter grip slowly until you feel a definite resistance and then give it a brisk, strong pull.

The **second** recommended **method** for starting your chainsaw allows you to start the saw without placing it on the ground. Make sure the chain brake is engaged, grip the front handle of the chainsaw firmly with your left hand. Keep your arm on the front handle in a locked (straight) position. Hold the rear handle of the saw tightly between your legs just above the knees. Maintain good balance and secure footing. Pull the starting grip slowly with your right hand until you feel a definite resistance and then give it a brisk, strong pull.

⚠ Warning!

Be sure that the guide bar and chain are clear of you and all other obstructions and objects, including the ground. When the engine is started, the engine speed with the starting throttle lock engaged will be fast enough for the clutch to engage the sprocket and, if the chain brake is not activated, turn the chain. If the upper quadrant of the tip of the bar touches any object, it may cause kick-back to occur (see section on reactive forces). To reduce this risk, always engage the chain brake before starting. Never attempt to start the chainsaw when the guide bar is in a cut or kerf.

⚠ Warning!

When you pull the starter grip, do not wrap the starting rope around your hands. Do not allow the grip to snap back, but guide the starter rope slowly back to permit the rope to rewind properly. Failure to follow this procedure may result in injury to hand or fingers and may damage the starter mechanism.

Important adjustments**⚠ Warning!**

To reduce the risk of personal injury from loss of control or contact with the running chain, do not use a saw with incorrect idle adjustment. At correct idle speed, the chain should not rotate. For directions to adjust idle speed, see the appropriate section of your Owner's Manual. If you cannot set the correct idle speed, have your STIHL dealer check your saw and make proper adjustments or repairs. After adjusting a chain, start the saw, let the engine run for a while, then switch engine off and recheck chain tension. Proper chain tension is very important at all times.

Catalytic converter**⚠ Warning!**

Some STIHL chainsaw models are equipped with a catalytic converter, which is designed to reduce the exhaust emissions of the engine by a chemical process in the muffler. Due to this process, the muffler does not cool down as rapidly as conventional mufflers when the engine returns to idle or is shut off. To reduce the risk of fire and burn injuries, specific safety precautions must be observed.

⚠ Warning!

Since a muffler with a catalytic converter cools down less rapidly than conventional mufflers, never set your chainsaw down on or near dry

brush, grass, wood chips or other combustible materials while it is still hot. Let the engine cool down sitting on concrete, metal, bare ground or solid wood (e.g. the trunk of a felled tree) away from any combustible substances.

⚠ Warning!

To reduce the risk of fire or burn injury, let the unit cool down before refueling your chainsaw after use.

⚠ Warning!

Never disassemble or modify your muffler. The muffler could be damaged and cause an increase in heat radiation or sparks, thereby increasing the risk of fire or burn injury. You may also permanently damage the engine. Have your muffler serviced and repaired by your STIHL Servicing Dealer only.

⚠ Warning!

To reduce the risk of fire or burn injury, keep the area around the muffler clean. Remove all debris such as pine needles, branches or leaves.

⚠ Warning!

An improperly mounted or damaged cylinder housing or a damaged/ deformed muffler shell may interfere with the cooling effect of the catalytic converter. To reduce the risk of fire or burn injury, do not continue work with a damaged or improperly mounted cylinder housing or a damaged/ deformed muffler shell. Your catalytic converter is furnished with screens designed to reduce the risk of fire from the emission of hot particles. Due to the heat from the catalytic reaction, these screens will normally stay clean and need no service or maintenance. If you experience loss of performance and you suspect a clogged screen, have your muffler maintained by a STIHL Servicing Dealer.

Working Conditions

Operate the chainsaw under good visibility and daylight conditions only.

⚠ Warning!



Your chainsaw produces poisonous exhaust fumes as soon as the combustible engine is running. These gases (e.g. carbon monoxide)

may be colorless and odorless. To reduce the risk of serious or fatal injury from breathing toxic fumes, never run the chainsaw indoors or in poorly ventilated locations. Ensure proper ventilation when working in trenches or other confined areas.

⚠ Warning!

Use of this product (including sharpening the saw chain) can generate dust, mists and fumes containing chemicals known to cause respiratory disease, cancer, birth defects, or other reproductive harm. If you are unfamiliar with the risks associated with the particular dust, mist or fume at issue, consult your employer, governmental agencies such as OSHA and NIOSH and other sources on hazardous materials. California and some other authorities, for instance, have published lists of substances known to cause cancer, reproductive toxicity, etc. Control dust (such as sawdust), mists (such as oil mist from chain lubrication) and fumes at the source where possible.

In this regard use good work practices and follow the recommendations of OSHA / NIOSH and occupational and trade associations. When the inhalation of toxic dust, mists and fumes cannot be eliminated, the operator and any bystanders should always wear a respirator approved by NIOSH / MSHA for the type substance at issue.

⚠ Warning!

Breathing asbestos dust is dangerous and can cause severe or fatal injury, respiratory illness or cancer. The use and disposal of asbestos containing products have been strictly regulated by OSHA and the Environmental Protection Agency. Do not cut or disturb asbestos, asbestos containing products (e.g. asbestos containing drywall or other construction products), or products such as pipes which are wrapped or covered with asbestos insulation. If you have any reason to believe that you might be cutting asbestos, immediately contact your employer or a local OSHA representative.

The muffler and other parts of the engine (e.g. fins of the cylinder, spark plug) become hot during operation and remain hot for a while after stopping the engine. To reduce risk of burns do not touch the muffler and other parts while they are hot. Don't work alone. Keep within calling distance of others in case help is needed.

Your chainsaw is equipped with a chain catcher. It is designed to reduce the risk of personal injury in the event of a thrown or broken chain. From time to time the catcher may be damaged or removed.

To reduce the risk of personal injury, do not operate a chainsaw with a damaged or missing catcher.

Inspect buffers periodically. Replace damaged, broken or excessively worn buffers immediately, since they may result in loss of control of the saw.

A "sponginess" in the feel of the saw, increased vibration or increased "bottoming" during normal operation may indicate damage, breakage or excessive wear. Buffers should always be replaced in sets. If you have any questions as to whether the buffers should be replaced, consult your STIHL servicing dealer.

Warning!

Take extreme care in wet and freezing weather (rain, snow, ice). Put off the work when the weather is windy, stormy or rainfall is heavy.

Warning!

Avoid stumbling on obstacles such as stumps, roots or rocks and watch out for holes or ditches. Clear the area where you are working. Be extremely cautious when working on slopes or uneven ground. There is increased danger of slipping on freshly debarked logs.

Warning!



To reduce the risk of serious or fatal injury to the operator or bystanders, never use the saw with one hand.

You cannot control reactive forces and you may lose control of the saw, which can result in the skating or bouncing of the bar and chain along the limb or log.

Even for those compact saws designed for use in confined spaces, one-handed operation is dangerous because the operator may lose control.

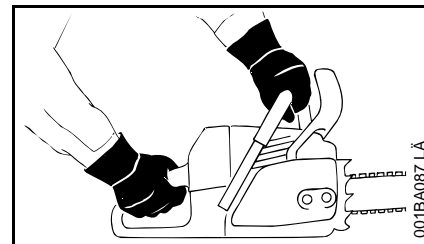

Cutting Instructions

Grip: Always hold the saw firmly with both hands when the engine is running. Place your left hand on front handle bar and your right hand on rear handle and throttle trigger. Left-handers should follow these instructions too.

Wrap your fingers tightly around the handles, keeping the handles cradled between your thumb and forefinger. With your hands in this position, you can best oppose and absorb the push, pull and kickback forces of your saw without losing control (see section on reactive forces). Make sure your chainsaw handles and grip are in good condition and free of moisture, pitch, oil or grease.

Warning!

Do not operate your chainsaw with the starting throttle lock engaged. Cutting with the starting throttle lock engaged does not permit the operator proper control of the saw or chain speed.

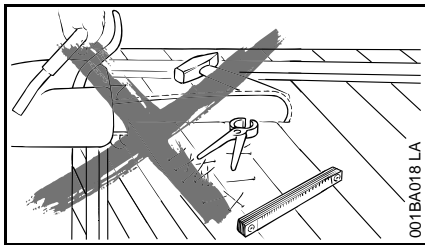

⚠ Warning!

Never touch a chain with your hand or any part of your body when the engine is running, even when the chain is not rotating. The chain continues to rotate for a short period after the throttle trigger is released.

⚠ Warning!

Do not cut any material other than wood or wooden objects. Use your saw for chainsawing only. It is not designed for prying or shoveling away limbs, roots or other objects. When sawing, make sure that the saw chain does not touch any foreign materials such as rocks, fences, nails and the like. Such objects may be flung off, damage the saw chain or cause the saw to kickback.

⚠ Warning!

In order to keep control of your saw, always maintain a firm foothold.

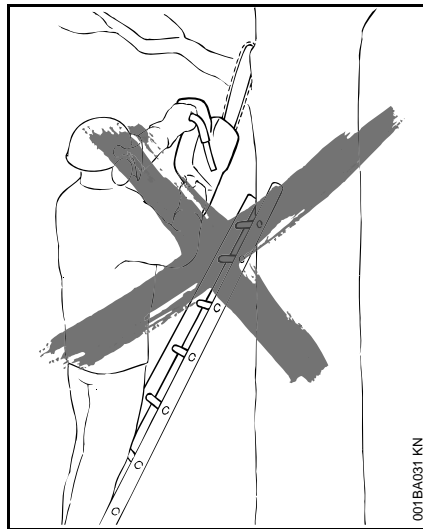

Never work on a ladder, or on any other insecure support. Never use the saw above shoulder height.

⚠ Warning!

Never work in a tree unless you have received specific, professional training for such work, are properly secured (such as tackle and harness system or a lift bucket), have both hands free for operating the chainsaw in a cramped environment and have taken proper precautions to avoid injury from falling limbs or branches.

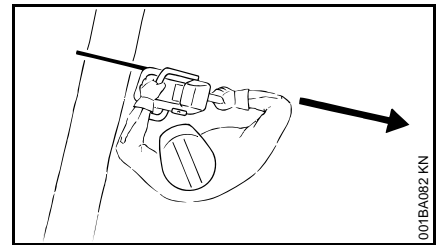

Position the chainsaw in such a way that your body is clear of the cutting attachment whenever the engine is running. Stand to the left of cut while bucking.

Don't put pressure on the saw when reaching the end of a cut. The pressure may cause the bar and rotating chain to pop out of the cut or kerf, go out of control and strike the operator or some other object. If the rotating chain strikes some other object, a reactive force may cause the moving chain to strike the operator.

Reactive forces including kickback

⚠ Warning!

Reactive forces may occur any time the chain is rotating. Reactive forces can be dangerous! In any chainsaw,

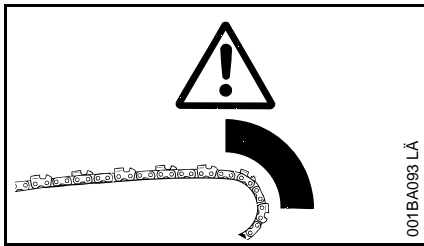

001BA093 LA

the powerful force used to cut wood can be reversed (and work against the operator). If the rotating chain is suddenly stopped by contact with any solid object like a log or branch or is pinched, there active forces may occur instantly. These reactive forces may result in loss of control which may, in turn, cause serious or fatal injury. An understanding of the causes of these reactive forces may help you avoid loss of control.

The most common reactive forces are

- kickback,
- pushback,
- pull-in.

Kickback:



Kickback may occur when the moving saw chain near the upper quadrant of the bar nose contacts a solid object or is pinched.

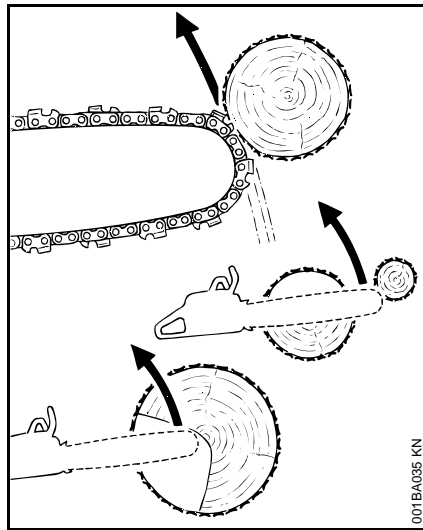

001BA035 KN

The reaction of the cutting force of the chain causes a rotational force on the chainsaw in the direction opposite to the chain movement. This may fling the bar up and back in an uncontrolled arc mainly in the plane of the bar. Under some cutting circumstances the bar moves towards the operator, who may suffer severe or fatal injury.

Kickback may occur, for example, when the chain near the upper quadrant of the bar nose contacts the wood or is pinched during limbing or when it is incorrectly used to begin a plunge or boring cut.

The greater the force of the kickback reaction, the more difficult it becomes for the operator to control the saw. Many factors influence the occurrence and force of the kickback reaction. These include chain speed, the speed at which the bar and chain contact the object, the angle of contact, the condition of the chain and other factors.

The type of bar and saw chain you use is an important factor in the occurrence and force of the kickback reaction. Some STIHL bar and chain types are designed to reduce kickback forces. STIHL recommends the use of reduced kickback bars and low kickback chains.

ANSI B 175.1-2000 chainsaw kickback standard

Section 5.11 of ANSI standard B 175.1-2000, sets certain performance and design criteria related to chainsaw kickback.

To comply with section 5.11 of ANSI B 175.1-2000:

- a) saws with a displacement of less than 3.8 cubic inches (62 cm³).
 - must, in their original condition, meet a 45° computer derived kickback angle when equipped with certain cutting attachments.
 - and must be equipped with at least two devices to reduce the risk of kickback injury, such as a chain brake, low kickback chain, reduced kickback bar, etc.

- b) saws with a displacement of 3.8 cubic inches (62 cm³) and above
 - must be equipped with at least one device designed to reduce the risk of kickback injury such as a chain brake, low kickback chain, reduced kickback bar, etc.

The computer derived angles for saws below 3.8 cubic inch (62 cm³) displacement are measured by applying a computer program to test results from a kickback test machine.

Warning!

The computer derived angles of § 5.11 of ANSI B 175.1-2000 may bear no relationship to actual kickback bar rotation angles that may occur in real life cutting situations.

In addition, features designed to reduce kickback injuries may lose some of their effectiveness when they are no longer in their original condition, especially if they have been improperly maintained. Compliance with § 5.11 of ANSI B 175.1-2000 does not automatically mean that in a real life kickback the bar and chain will rotate at most 45°.

Warning!

In order for powerheads below 3.8 cubic inch (62 cm³) displacement to comply with the computed kickback angle requirements of § 5.11 of ANSI B 175.1-2000 use only the following cutting attachments:

- bar and chain combinations listed as complying in the "Specifications" section of the Owner's Manual or
- other replacement bar and chain combinations marked in accordance with the standard for use on the powerhead or
- replacement chain designated "low kickback saw chain".

See the section on "Low kickback saw chain and reduced kickback bars"

Devices for reducing the risk of kickback injury

STIHL recommends the use of the STIHL Quickstop chain brake on your power-head with green labeled reduced kickback bars and low kickback chains.

Warning!

To reduce the risk of injury, stop using the saw immediately if the chain brake does not function properly. Take the saw to your local STIHL Service Center! Do not use the saw until the problem has been rectified (see the section "Chain Brake").

Quickstop chain brake

STIHL has developed a chain stopping system designed to reduce the risk of injury in certain kickback situations. It is called a Quickstop chain brake. The Quickstop is available as standard equipment on your STIHL chainsaw and is available for installation on most older STIHL saws. Ask your dealer to retrofit your older model saw with a chain brake.

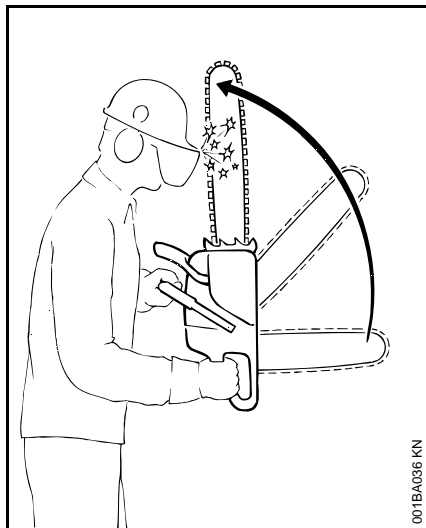

When a kickback occurs, the guide bar may rotate around the front handle. If the cutting position is such that the operator's left hand is gripping the front handle behind the hand guard, and if the left hand rotates around the front handle and makes a sufficiently forceful contact with the front hand guard, which is the Quickstop activating lever, this contact will activate the Quickstop. The chain brake on most new model STIHL chainsaws can also be activated by inertia. See the chapter entitled "Chain Brake" of your Owner's Manual.

⚠ Warning!

Never operate your chainsaw without a front hand guard. In a kickback situation this guard helps protect your left hand or other parts of your body. In addition, removal of the hand guard on a saw equipped with a chain brake will deactivate the chain brake.

⚠ Warning!

No Quickstop or other chain brake device prevents kickback. These devices are designed to reduce the risk of kickback injury, if activated, in certain kickback situations. In order for the Quickstop to reduce the risk of kickback injury, it must be properly maintained and in good working order. See the chapter entitled "Chain Brake" and "Maintenance, Repair and Storing" of your Owner's Manual. In addition, there must be enough distance between the bar and the operator to ensure that the Quickstop has sufficient time to activate and stop the chain before potential contact with the operator.

⚠ Warning!

An improperly maintained chain brake may increase the time needed to stop the chain after activation, or may not activate at all.

⚠ Warning!

Never run the chainsaw above idle speed for more than 3 seconds when the chain brake is engaged or the chain is pinched or otherwise caught in the cut. Clutch slippage can cause excessive heat, leading to severe damage of the motor housing, clutch and oiler component and may interfere with the operation of the chain brake. If clutch slippage in excess of 3 seconds has occurred, allow the motor housing to cool before proceeding and check the operation of your chain brake as described in the chapter entitled "Chain Brake". Also make sure that the chain is not turning at idle speed (see above "Important Adjustments").

Low kickback saw chain and reduced kickback bars

STIHL offers a variety of bars and chains. STIHL reduced kickback bars and low kickback chains are designed to

reduce the risk of kickback injury. Other chains are designed to obtain higher cutting efficiency or sharpening ease but may result in higher kickback tendency.

STIHL has developed a color codesystem to help you identify the STIHL reduced kickback bars and low kickback chains. Cutting attachments with green warning decals or green labels on the packaging are designed to reduce the risk of kickback injury. The matching of green decaled powerheads under 3.8 cubic inch (62 cm³) displacement with green labeled bars and green labeled chains gives compliance with the computed kickback angle requirements of ANSI B 175.1-2000 when the products are in their original condition. Products with yellow decals or labels are for users with extraordinary cutting needs and experience and specialized training for dealing with kickback.

STIHL recommends the use of its green labeled reduced kickback bars, green labeled low kickback chains and a STIHL Quickstop chain brake for both experienced and inexperienced chainsaw users.

Please ask your STIHL dealer to properly match your powerhead with the appropriate bar/chain combinations to reduce the risk of kickback injury. Green labeled bars and chains are recommended for all powerheads. See your "STIHL Bar and Chain Information" leaflet for details.

 **Warning!**

Use of other, non-listed bar/chain combinations may increase kickback forces and increase the risk of kickback injury. New bar/chain combinations may be developed after publication of this literature, which will, in combination with certain powerheads, comply with § 5.11 of ANSI B 175.1-2000. Check with your STIHL dealer for such combinations.

 **Warning!**

Reduced kickback bars and low kickback chains do not prevent kickback, but they are designed to reduce the risk of kickback injury. They are available from your STIHL dealer.

 **Warning!**

Even if your saw is equipped with a Quickstop, a reduced kickback bar and/or low kickback chain, this does not eliminate the risk of injury by kickback. Therefore, always observe all safety precautions to avoid kickback situations.

Low kickback chain

Some types of saw chain have specially designed components to reduce the force of nose contact kickback. STIHL has developed low kickback chain for your powerhead.

"Low kickback saw chain" is a chain which has met the kickback performance requirements of § 5.11.2.4 of ANSI B 175.1-2000 (Safety Requirements for Gasoline-Powered ChainSaws) when tested in its original condition on a selected representative sample of chainsaws below 3.8 cubic inch (62 cm³) displacement specified in ANSI B 175.1-2000.

 **Warning!**

There are potential powerhead and bar combinations with which low kickback saw chains can be used which have not been specifically certified to comply with the 45° computer derived kickback angle of § 5.11 of ANSI B 175.1-2000. Some low kickback chains have not been tested with all powerhead and bar combinations.

 **Warning!**

A dull or improperly sharpened chain may reduce or negate the effects of the design features intended to reduce

kickback energy. Improper lowering or sharpening of the depth gauges or shaping of the cutters may increase the chance and the potential energy of a kickback. Always cut with a properly sharpened chain.

Reduced kickback bar

STIHL green labeled reduced kickback bars are designed to reduce the risk of kickback injury when used with STIHL green labeled low kickback chains.

Warning!

When used with other, more aggressive chains, these bars may be less effective in reducing kickback, and may result in higher kickback forces.

Bow Guides

Warning!

Do not mount a bow guide on any STIHL chainsaw. Any chainsaw equipped with a bowguide is potentially very dangerous. The risk of kickback is increased with a bow guide because of the increased kickback contact area. Low kickback chain will not significantly reduce the risk of kickback injury when used on a bow guide.

To avoid kickback

The best protection from personal injury that may result from kickback is to avoid kickback situations:

1. Hold the chainsaw firmly with both hands and maintain a secure grip.
2. Be aware of the location of the guide bar nose at all times.
3. Never let the nose of the guide bar contact any object. Do not cut limbs with the nose of the guide bar. Be especially careful when cutting small, tough limbs, small size brush and saplings which may easily catch the chain.
4. Don't overreach.
5. Don't cut above shoulder height.
6. Begin cutting and continue at full throttle.
7. Cut only one log at a time.
8. Use extreme caution when reentering a previous cut.
9. Do not attempt to plunge cut if you are not experienced with these cutting techniques.
10. Be alert for shifting of the log or other forces that may cause the cut to close and pinch the chain.
11. Maintain saw chain properly. Cut with a correctly sharpened, properly tensioned chain at all times.
12. Stand to the side of the cutting path of the chainsaw.

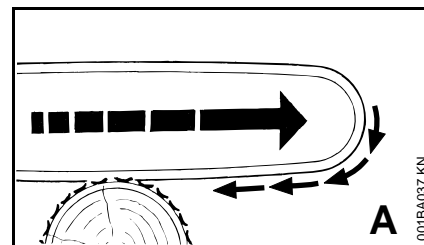

A = Pull-in:

Pull-in occurs when the chain on the bottom of the bar is suddenly stopped when it is pinched, caught or encounters a foreign object in the wood. The reaction of the chain pulls the saw forward and may cause the operator to lose control.

Pull-in frequently occurs when the bumper spike of the saw is not held securely against the tree or limb and when the chain is not rotating at full speed before it contacts the wood.

Warning!

Use extreme caution when cutting small size brush and saplings which may easily catch the chain and pull you off balance.

To avoid pull-in

1. Always start a cut with the chain rotating at full speed and the bumper spike in contact with the wood.
2. Pull-in may also be prevented by using wedges to open the kerf or cut.

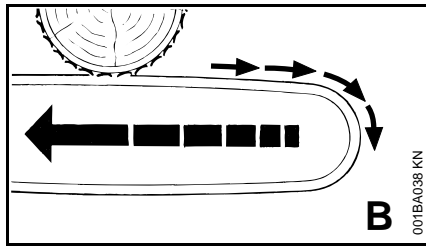

B = Pushback:

Pushback occurs when the chain on the top of the bar is suddenly stopped when it is pinched, caught or encounters a foreign object in the wood. The reaction of the chain drives the saw straight back toward the operator and may cause loss of saw control. Pushback frequently occurs when the top of the bar is used for cutting.

To avoid pushback

1. Be alert to forces or situations that may cause material to pinch the top of the chain.
2. Do not cut more than one log at a time.
3. Do not twist the saw when withdrawing the bar from a plunge cut or underbuck cut because the chain can pinch.

Cutting Techniques

Felling

Felling is cutting down a tree.

Before felling a tree, consider carefully all conditions which may affect the direction of fall, including:

The intended direction of the fall.

The natural lean of the tree.

Any unusually heavy limb structure.

Surrounding trees and obstacles.

The wind direction and speed.

⚠ Warning!

Always observe the general condition of the tree. Inexperienced users should never attempt to cut trees which are decayed or rotted inside or which are leaning or otherwise under tension. There is an increased risk that such trees could snap or split while being cut and cause serious or fatal injury to the operator or bystanders. Also look for broken or dead branches which could vibrate loose and fall on the operator. When felling on a slope, the operator should stand on the uphill side if possible.

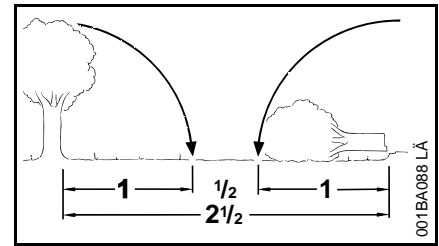

Felling Instructions:

When felling, maintain a distance of at least $2\frac{1}{2}$ tree lengths from the nearest person.

When felling in the vicinity of roads, railways and power lines, etc., take extra precautions. Inform the police, utility company or railway authority before beginning to cut.

⚠ Warning!

The noise of your engine may drown any warning call.

⚠ Warning!

There are a number of factors that may affect and change the intended direction of fall, e.g. wind, lean of tree, sloping ground, one-sided limb structure, wood structure, decay, snow load, etc. To reduce the risk of severe or fatal injury to yourself or others, look for these conditions prior to beginning the cut, and be alert for a change in direction while the tree is falling.

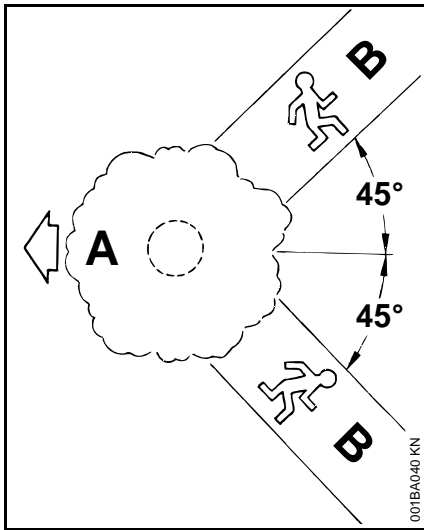

Escape path

First clear the tree base and work area from interfering limbs and brush and clean its lower portion with an ax.

Then, establish two paths of escape (B) and remove all obstacles. These paths should be generally opposite to the planned direction of the fall of the tree (A) and about at a 45° angle. Place all tools and equipment a safe distance away from the tree, but not on the escape paths.



Buttress roots

If the tree has large buttress roots, cut into the largest buttress vertically first (horizontally next) and remove the resulting piece.

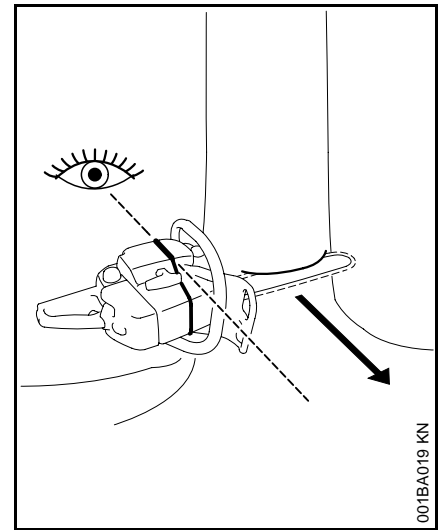

Gunning sight

When making the felling notch, use the gunning sight on the shroud and housing to check the required direction of fall:

- Position the saw so that the gunning sight points exactly in the direction you want the tree to fall.

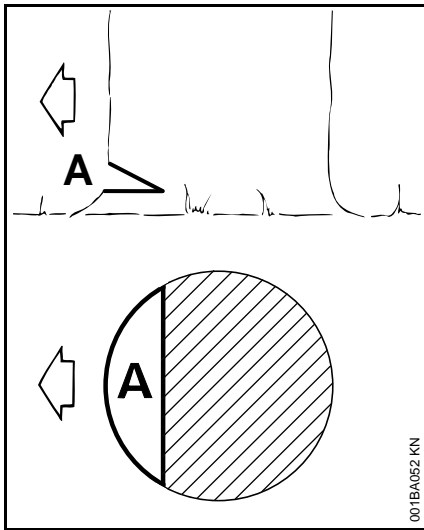

Conventional cut

A = felling notch - determines the direction of the fall

For a conventional cut:

- Properly place felling notch perpendicular to the line of fall, close to the ground
- Cut down at app. 45-degree angle to a depth of about 1/5 to 1/4 of the trunk diameter
- Make second cut horizontal
- Remove resulting 45-degree piece

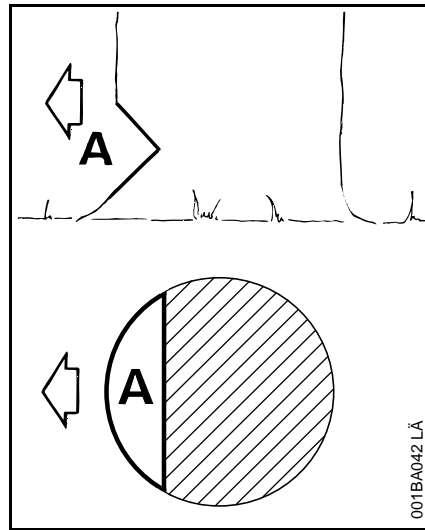

Open-face technique

A = felling notch - determines the direction of the fall

For an open-face cut:

- Properly place felling notch perpendicular to the line of fall, close to the ground
- Cut down at app. 50-degree angle to a depth of app. 1/5 to 1/4 of the trunk diameter
- Make second cut from below at app. 40 degree angle
- Remove resulting 90-degree piece

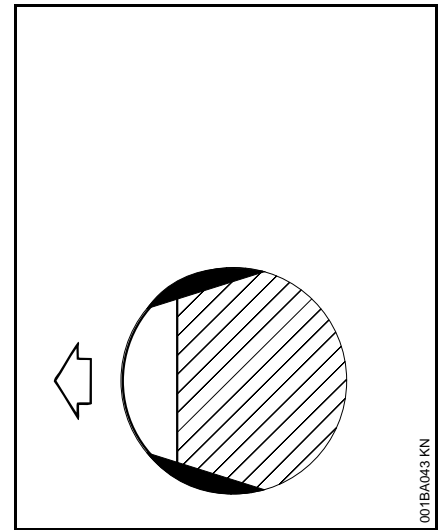

Making sapwood cuts

- For medium sized or larger trees make cuts at both sides of the trunk,
- at same height as subsequent felling cut.
- Cut to no more than width of guide bar.

This is especially important in softwood in summer - it helps prevent sapwood splintering when the tree falls.

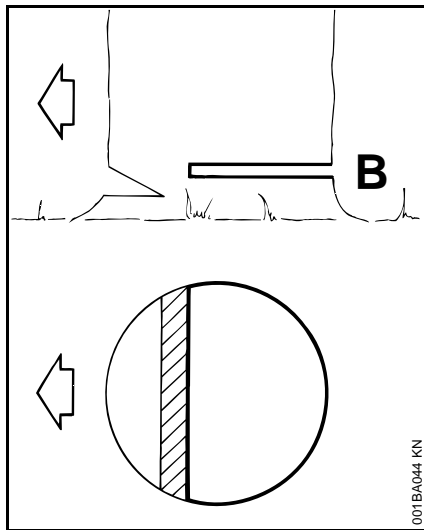

B = Felling cut

Conventional and open-face technique:

- Begin 1 to 2 inches (2,5 to 5 cm) higher than centre of felling notch
- Cut horizontally towards the felling notch
- Leave approx. 1/10 of diameter uncut. This is the hinge
- Do not cut through the hinge - you could lose control of the direction of the fall

Drive wedges into the felling cut where necessary to control the fall.

⚠ Warning!

If the tip of the bar contacts a wedge, it may cause kickback. Wedges should be of wood or plastic - never steel, which can damage the chain.

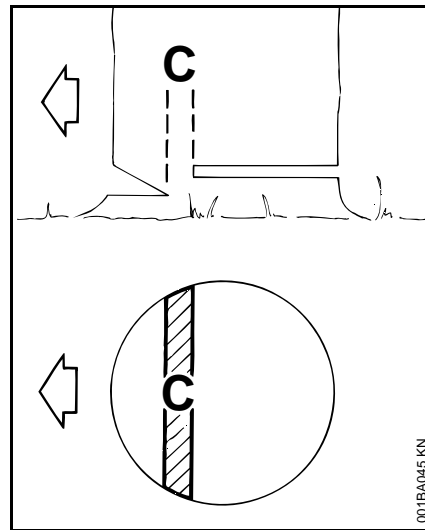

C = Hinge

- Helps control the falling tree
- Do not cut through the hinge - you could lose control of the direction of the fall

⚠ Warning!

In order to reduce the risk of personal injury, never stand directly behind the tree when it is about to fall, since part of the trunk may split and come back towards the operator (barber-chairing), or the tree may jump backwards off the stump. Always keep to the side of the falling tree. When the tree starts to fall, withdraw the bar, shut off the engine and walk away on the preplanned escape path. Watch out for falling limbs.

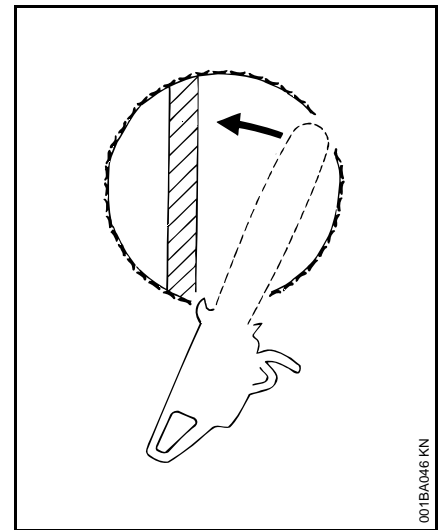

⚠ Warning!

Be extremely careful with partially fallen trees which are poorly supported. When the tree hangs or for some other reason does not fall completely, set the saw aside and pull the tree down with a cable winch, block and tackle or tractor. If you try to cut it down with your saw, you may be injured.

Felling cut for small diameter trees: simple fan cut

Engage the bumper spikes of the chainsaw directly behind the location of the intended hinge and pivot the saw around this point only as far as the hinge. The bumper spike rolls against the trunk.

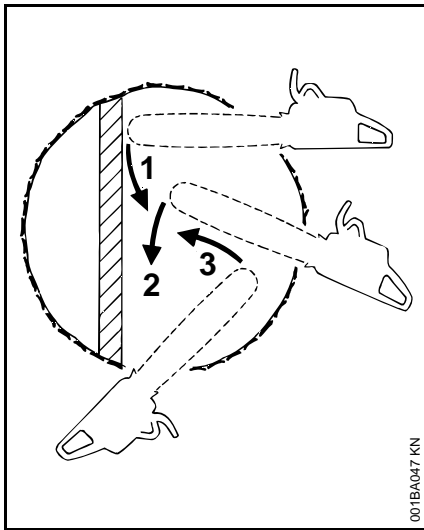

001BA047 KN

Felling cut for large diameter trees:

⚠ Warning!

Felling a tree that has a diameter greater than the length of the guide bar requires use of either the sectioning felling cut or plunge-cut method. These methods are extremely dangerous because they involve the use of the nose of the guide bar and can result in kickback. Only properly trained professionals should attempt these techniques.

Sectioning method

For the sectioning method make the first part of the felling cut with the guide bar fanning in toward the hinge. Then, using the bumper spike as a pivot, reposition the saw for the next cut.

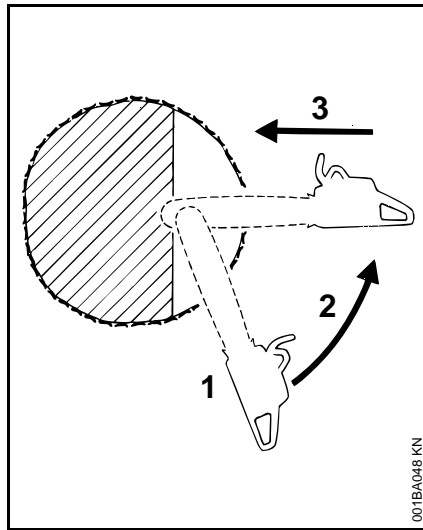

001BA048 KN

Avoid repositioning the saw more than necessary. When repositioning for the next cut, keep the guide bar fully engaged in the kerf to keep the felling cut straight. If the saw begins to pinch, insert a wedge to open the cut. On the last cut, do not cut the hinge.

Plunge-cut method

Timber having a diameter more than twice the length of the guide bar requires the use of the plunge-cut method before making the felling cut.

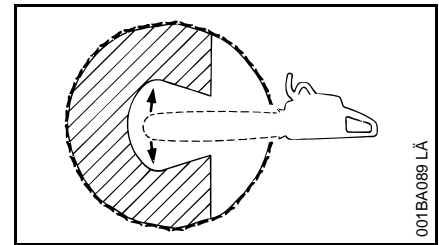

001BA089 LÄ

First, cut a large, wide felling notch. Make a plunge cut in the centre of the notch.

The plunge cut is made with the guide bar nose. Begin the plunge cut by applying the lower portion of the guide bar nose to the tree at an angle. Cut until the depth of the kerf is about the same as the width of the guide bar. Next, align the saw in the direction in which the recess is to be cut.

With the saw at full throttle, insert the guide bar in the trunk.

Enlarge the plunge cut as shown in the illustration.

⚠ Warning!

There is an extreme danger of kickback at this point. Extra caution must be taken to maintain control of the saw. To make the felling cut, follow the sectioning method described previously.

If you are inexperienced with a chainsaw, plunge-cutting should not be attempted. Seek the help of a professional.

Limbing

Limbing is removing the branches from a fallen tree.

Warning!

There is an extreme danger of kickback during the limbing operation. Do not work with the nose of the bar. Be extremely cautious and avoid contacting the log or other limbs with the nose of the guide bar.

Do not stand on a log while limbing it - you may slip or the log may roll.

Start limbing by leaving the lower limbs to support the log off the ground. When underbucking freely hanging limbs, a pinch may result or the limb may fall, causing loss of control. If a pinch occurs, stop the engine and remove the saw, by lifting the limb.

Warning!

Be extremely cautious when cutting limbs or logs under tension (spring poles). The limbs or logs could spring back toward the operator and cause loss of control of the saw and severe or fatal injury to the operator.

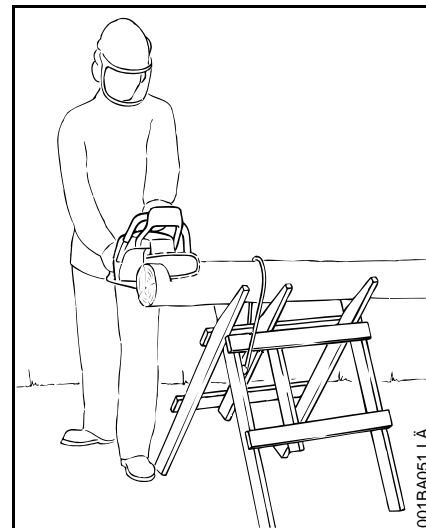
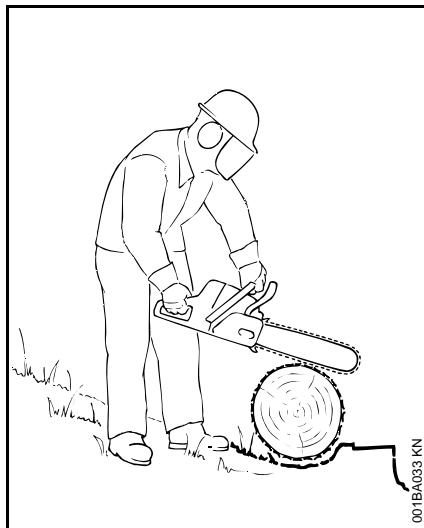

Bucking

Bucking is cutting a log into sections.

Warning!

1. When bucking, do not stand on the log. Make sure the log will not roll downhill. If on a slope, stand on the uphill side of the log. Watch out for rolling logs.

2. Cut only one log at a time.
3. Shattered wood should be cut very carefully. Sharp splinters of wood may be caught and flung in the direction of the operator of the saw.
4. When cutting small logs, place log through "V" - shaped supports on top of a sawhorse. Never permit another person to hold the log. Never hold the log with your leg or foot.

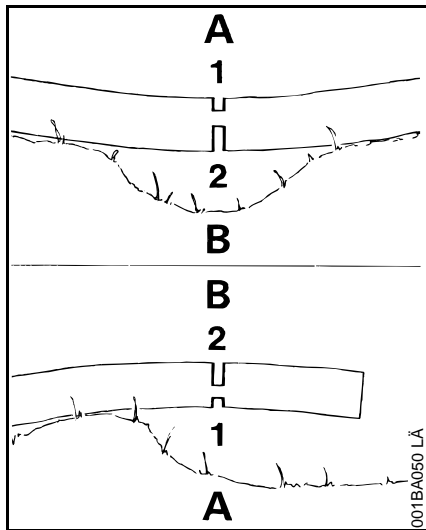

5. Logs under strain: Risk of pinching! Always start relieving cut (1) at compression side (A). Then make bucking cut (2) at tension side (B). If the saw pinches, stop the engine and remove it from the log.
6. Only properly trained professionals should work in an area where the logs, limbs and roots are tangled. Working in blow down areas is extremely hazardous.
7. Drag the logs into a clear area before cutting. Pull out exposed and cleared logs first.

MAINTENANCE, REPAIR AND STORING

Maintenance, replacement, or repair of the emission control devices and systems may be performed by any nonroad engine repair establishment or individual. However if you claim warranty for a component which has not been serviced or maintained properly or if nonapproved replacement parts were used, STIHL may deny warranty.

Never operate a chainsaw that is damaged, improperly adjusted or not completely or securely assembled. Follow the maintenance and repair instructions in the appropriate section of your Owner's Manual, especially those in the chapters "Mounting the Bar and Chain", "Maintaining and Sharpening" and "Chain Brake".

Warning!

Use only STIHL replacement parts for maintenance and repair. Use of parts manufactured by others may cause serious or fatal injury.

Warning!

Always stop the engine and ensure that the chain is stopped before making any adjustments, maintenance or repair work,

changing the saw chain or cleaning the saw. Do not attempt any maintenance or repair work not described in your Owner's Manual. Have such work performed at your STIHL service shop only.

Warning!

Never test the ignition system with ignition wire terminal removed from sparkplug or with unseated spark plug, since uncontained sparking may cause a fire.

Warning!

To reduce the risk of fire and burn injury, use only spark plugs authorized by STIHL. Always press spark plug boot snugly onto spark plug terminal of the proper size. (Note: If terminal has detachable SAE adapter nut, it must be attached.) A loose connection between spark plug terminal and ignition wire connector in the boot may create arcing that could ignite combustible fumes and cause a fire. Keep spark plug clean, and make sure ignition lead is in good condition.

Warning!

Do not operate your chainsaw if the muffler is damaged, missing or modified. An improperly maintained muffler will increase the risk of fire and hearing loss. Never touch a hot muffler or burn will

result. If your muffler was equipped with a spark-arresting screen to reduce the risk of fire (e. g. in the USA, Canada and Australia), never operate your saw if the screen is missing or damaged.

Remember that the risk of forest fires is greater in hot or dry weather.

Keep the chain, bar and sprocket clean; replace worn sprockets or chains. Keep the chain sharp.

You can spot a dull chain when easy-to-cut wood becomes hard to cut and burn marks appear on the wood.

Keep the chain at proper tension.

Tighten all nuts, bolts and screws except the carburetor adjustment screws after each use.

Warning!

In order for the chain brake on your STIHL chainsaw to properly perform its function of reducing the risk of kickback and other injuries, it must be properly maintained. Like an automobile brake, a chainsaw chain brake incurs wear each time it is engaged.

The amount of wear will vary depending upon usage, conditions under which the saw is used and other factors. Excessive wear will reduce the effectiveness of the chain brake and can render it inoperable.

For the proper and effective operation of the chain brake the brake band and clutch drum must be kept free of dirt, grease and other foreign matter which may reduce friction of the band on the drum.

For these reasons, each STIHL chainsaw should be returned to trained personnel such as your STIHL servicing dealer for periodic inspection and servicing of the brake system according to the following schedule:

Heavy usage - every three months,

Moderate usage - twice a year,

Occasional usage - annually.

The chainsaw should also be returned immediately for maintenance whenever the brake system cannot be thoroughly cleaned or there is a change in its operating characteristics.

For any maintenance please refer to the maintenance chart **and to the warranty statement** near the end of this manual.

Additionally, the daily maintenance schedule for your chainsaw set forth in your STIHL Owner's Manual should be strictly followed.

Store chainsaw in a dry place and away from children. Before storing for longer than a few days, always empty the fuel tank (see chapter "Storing the Machine" in this manual).

Maintenance Chart

Please note that the following maintenance intervals apply for normal operating conditions only. If your daily working time is longer than normal or cutting conditions are difficult (very dusty work area, resin-rich wood, tropical wood etc.), shorten the specified intervals accordingly. If you only use the saw occasionally, extend the intervals accordingly.		before starting work	after finishing work or daily	after each refueling stop	weekly	monthly	every 12 months	if problem	if damaged	as required
Complete machine	Visual inspection (condition, leaks)	X		X						
	Clean		X							
Throttle trigger, trigger interlock, Master Control	Check operation	X		X						
Chain brake	Check operation	X		X						
	Check ¹⁾²⁾									X
Pickup body/filter in fuel tank	Check					X				
	Clean, replace filter element					X		X		
	Replace pickup body						X		X	X
Fuel tank	Clean					X				
Chain oil tank	Clean					X				
Chain lubrication	Check	X								
Saw chain	Inspect, also check sharpness	X		X						
	Check chain tension	X		X						
	Sharpen									X
Guide bar	Check (wear, damage)	X								
	Clean and turn over									X
	Deburr				X					
	Replace								X	X
Chain sprocket	Check				X					
	Clean							X		X
Air filter	Replace								X	
	Inspect							X		X
AV elements (rubber buffers, springs)	Replace ¹⁾								X	
	Inspect							X		X
Cooling inlets	Clean		X							
Cylinder fins	Clean		X			X				

1) STIHL dealer

2) see "Chain brake"

Please note that the following maintenance intervals apply for normal operating conditions only. If your daily working time is longer than normal or cutting conditions are difficult (very dusty work area, resin-rich wood, tropical wood etc.), shorten the specified intervals accordingly. If you only use the saw occasionally, extend the intervals accordingly.		before starting work	after finishing work or daily	after each refueling stop	weekly	monthly	every 12 months	if problem	if damaged	as required
Carburetor	Check idle adjustment – chain must not rotate	X		X						
	Readjust idle									X
Spark plug	Readjust electrode gap						X			
All accessible screws and nuts (not adjusting screws) ²⁾	Retighten									X
Spark arresting screen* in muffler	Inspect						X			
	Clean or replace								X	
Chain catcher	Check	X								
	Replace								X	

- 2) Firmly tighten cylinder base screws of professional saws (3.4 kW or more) after 10 to 20 hours of operation

* see “Guide to Using this Manual“

Main Parts of the Saw

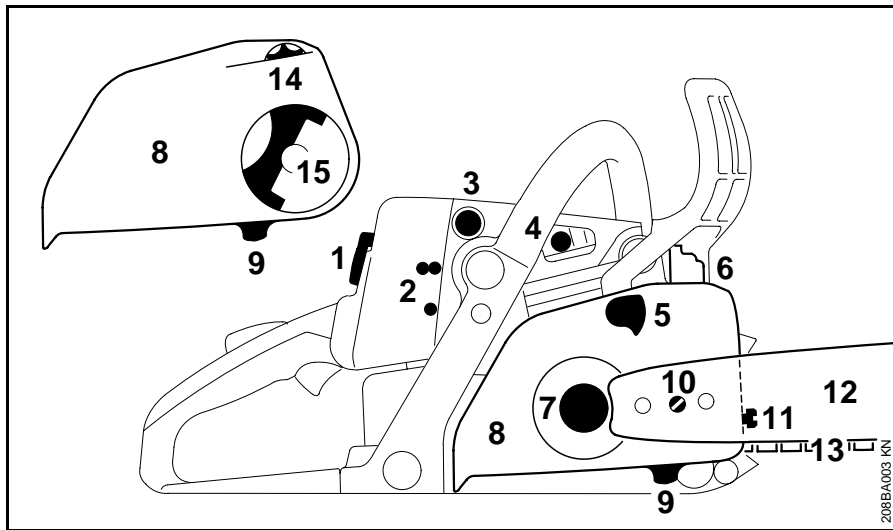

- 1 Twist lock
- 2 Carburetor adjusting screws
- 3 Fuel pump (easy start*)
- 4 Decompression valve*
- 5 Chain brake
- 6 Muffler
- 7 Chain sprocket
- 8 Chain sprocket cover
- 9 Chain catcher
- 10 Chain tensioner (side)
- 11 Chain tensioner (front)
- 12 Guide bar
- 13 Oilomatic saw chain
- 14 Adjusting wheel of quick tensioner*
- 15 Handle of wingnut* (quick chain tensioner)

* see "Guide to Using this Manual"

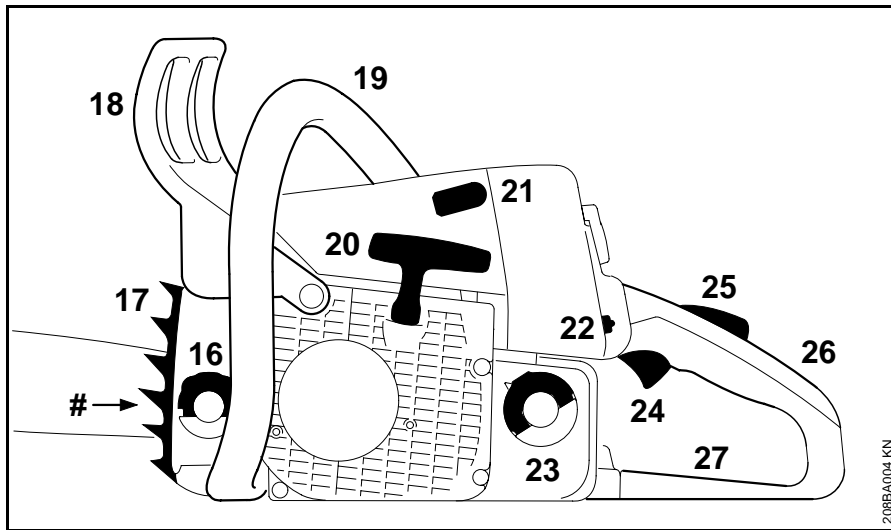

- 16 Oil filler cap
- 17 Bumper spike
- 18 Front hand guard
- 19 Front handle (handelbar)
- 20 Starter grip
- 21 Spark plug boot
- 22 Master Control lever
- 23 Fuel filler cap
- 24 Throttle trigger
- 25 Throttle trigger interlock
- 26 Rear handle
- 27 Rear hand guard
- # Serial number

Definitions

- 1 Twist Lock**
Lock for carburetor box cover.
- 2 Carburetor Adjusting Screws**
For fine tuning the carburetor.
- 3 Fuel Pump**
Fills carburetor with fuel to simplify starting.
- 4 Decompression Valve**
Releases compression pressure to make starting easier.
- 5 Chain Brake**
A device to stop the rotation of the chain if activated in a kickback situation by the operator's hand or by inertia.
- 6 Muffler**
Reduces engine exhaust noise and directs the exhaust gases.
- 7 Chain Sprocket**
The toothed wheel that drives the saw chain.
- 8 Chain Sprocket Cover**
Covers the clutch and the sprocket.
- 9 Chain Catcher**
Helps to reduce the risk of operator contact by a chain if it breaks or comes off the bar.
- 10 Chain Tensioner**
Permits precise adjustment of chain tension.
- 11 Chain Tensioner**
Permits precise adjustment of chain tension.
- 12 Guide Bar**
Supports and guides the saw chain.
- 13 Oilomatic Saw Chain**
A loop consisting of cutters, tie straps and drive links.
- 14 Adjusting Wheel**
Permits precise adjustment of chain tension.
- 15 Handle of Wingnut**
Must be released to allow chain to be tensioned with adjusting wheel.
- 16 Oil Filler Cap**
For closing the oil tank.
- 17 Bumper Spike**
Toothed stop for holding saw steady against wood.
- 18 Front Hand Guard**
Provides protection against projecting branches and helps prevent left hand from touching the chain if it slips off the handlebar. It also serves as the lever for chain brake activation.
- 19 Front Handle (Handlebar)**
Handlebar for the left hand at the front of the saw.
- 20 Starter Grip**
The grip of the starter, for starting the engine.
- 21 Spark Plug Boot**
Connects the spark plug with the ignition wire.
- 22 Master Control Lever**
Lever for choke control, starting throttle, run and stop positions.
- 23 Fuel Filler Cap**
For closing the fuel tank.
- 24 Throttle Trigger**
Controls the speed of the engine.
- 25 Throttle Trigger Interlock**
Must be depressed before the throttle trigger can be activated.

26 Rear Handle

The support handle for the right hand, located at the rear of the saw.

27 Rear Hand Guard

Gives added protection to operator's right hand.

Guide Bar Nose

The exposed end of the guide bar.
(not illustrated, see chapter "Tensioning the Saw Chain")

Clutch

Couples engine to chain sprocket when engine is accelerated beyond idle speed (not illustrated).

Anti-Vibration System

The anti-vibration system includes a number of buffers designed to reduce the transmission of vibrations created by the engine and cutting attachment to the operator's hands (not illustrated).

 **WARNING!**

The engine exhaust from this product contains chemicals known to the State of California to cause cancer, birth defects or other reproductive harm.

0457 184 3021

englisch / English USA