

# **STIHL 031, 032**

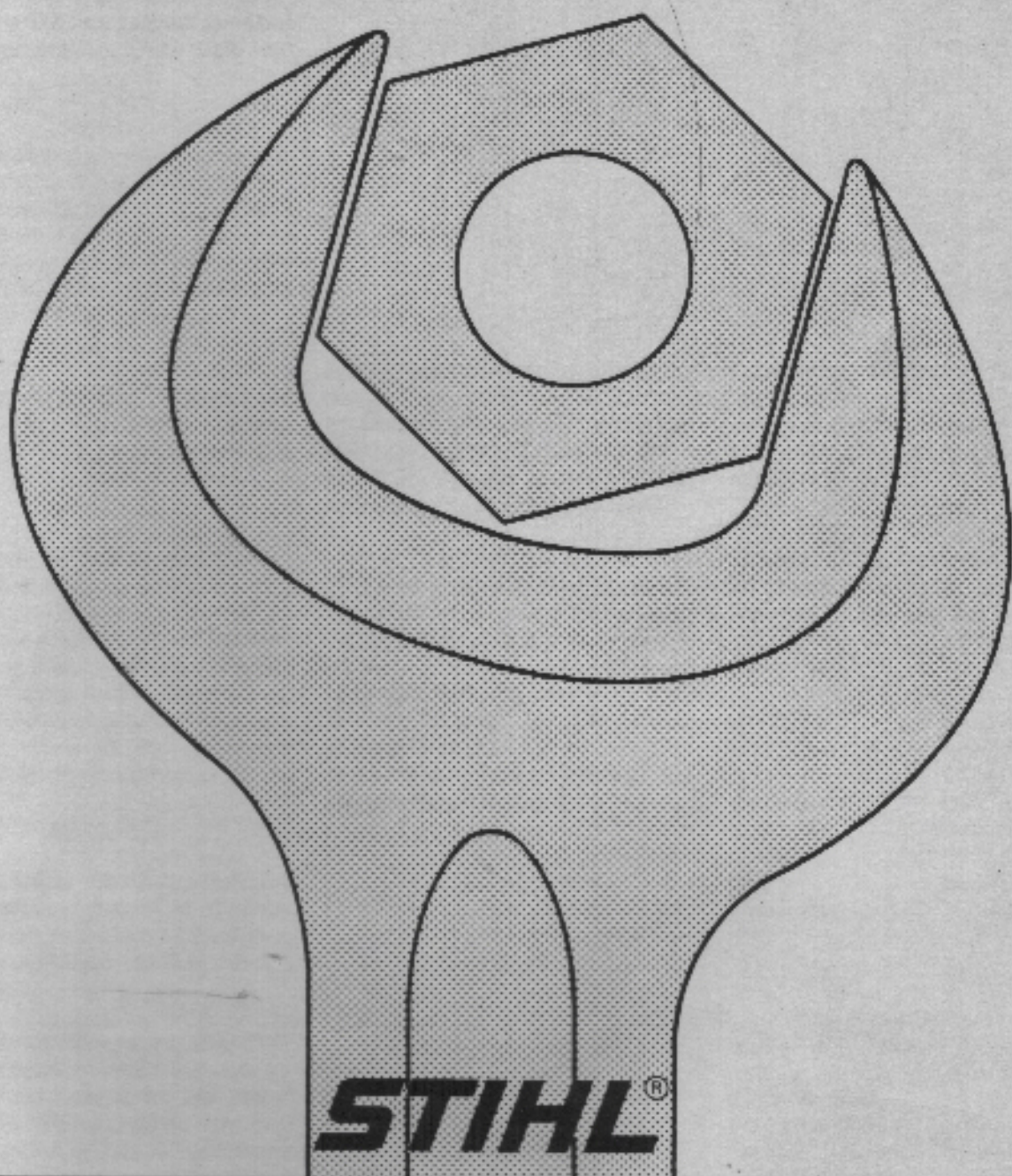



**SERVICE MANUAL**  
**032 AV (031 AV, 030 AV)**

**SPECIAL TOOL MANUAL**

**FOREWORD**

This service manual covers model 032 chain saws from machine No. 532 9921 onward (start of production) and can thus be used as a basis for professional overhauls and repairs.

The previous service manual for models 030 AV and 031 AV has been discontinued. As the models are substantially identical in their engineering design, the repair procedures in this manual can also be used for models 031/030.

Differences in construction have been dealt with separately and identified by the supplement "031 (030)".

In the event of faults it is quite possible that a single condition may have several causes. It is therefore advisable to consult the "Troubleshooting Charts" in all chapters when tracing faults. We also recommend you make use of the exploded views in the illustrated parts lists when carrying out repairs.

Our technical information bulletins give details of engineering changes which have been introduced since publication of this service manual.

This service manual and all technical information bulletins are intended exclusively for the use of STIHL servicing dealers and staff and must not be passed on to third parties.

Assembly stand

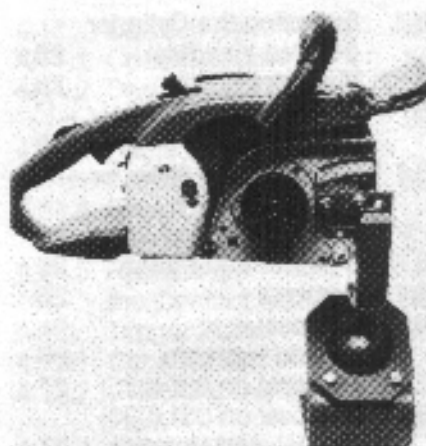

Repair work is made considerably easier if the chain saw is mounted on assembly stand 5910 850 3100. The saw is quickly attached to the stand by means of the two bar mounting studs and collar nuts.

While on the assembly stand the saw can be swivelled into any required position to suit the repair in question. This not only has the advantage of keeping the component in the best position for the repair but also leaves both hands free for the work and thus effects a considerable time saving.

Special tool manual

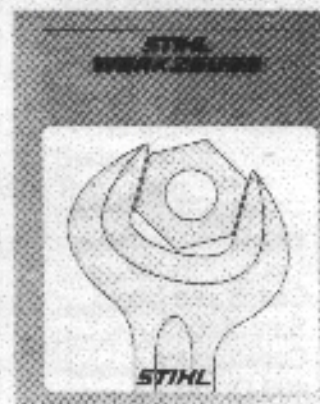

Our special tool manual illustrates and lists the part numbers of all available machine-related tools as well as general purpose tools for all machines.

The special tool manual is available in various languages and can be ordered by quoting the appropriate part number listed hereunder.

German	0455 901 0023
English	0455 901 0123
French	0455 901 0223
Spanish	0455 901 0323
Yugoslav	0455 901 0423
Swedish	0455 901 0523
Italian	0455 901 0723
Portuguese	0455 901 1223

**STIHL®**

Andreas Stihl  
 Postfach 1760  
 D-7050 Waiblingen  
 West Germany

## CONTENTS

1.	<b>Specifications - 032</b>	5	3.3.1	Exposing the Cylinder (Heated Handles)	23	3.8.2	Vacuum Test	38
1.1	Specifications - 031 (030)	8	3.4	Visual Inspection	23	3.8.3	Leakage Testing the Crankcase - 031 (030)	38
			3.5	Exposing the Cylinder - 031 (030)	23	3.8.4	Replacing the Oil Seals	39
			3.5.1	Exposing the Cylinder - 031 (030)				
2.	<b>Clutch, Chain Drive and Chain Brake</b>	9		Heated Handles	25	4.	<b>Ignition System</b>	
			3.6	Cylinder and Piston	26	4.1	Construction	40
			3.6.1	Removal	26	4.2	Description of Operation	40
2.1	Clutch and Chain Sprocket	9	3.6.1.1	Removal, Heated Handles	26	4.2.1	General	40
2.1.1	Construction and Operation	9	3.6.2	Removal on 031 (030)	27	4.2.2	Breaker-Controlled Magneto Ignition	40
2.1.2	Troubleshooting Chart	10	3.6.2.1	Removal on 031 (030) with Heated Handles	27	4.2.3	Transistor-Controlled Magneto Ignition	42
2.1.3	Disassembly and Repair	11	3.6.3	Visual Inspection	27	4.3	Troubleshooting Chart	43
2.1.3.1	Standard Clutch with 3 Springs	11	3.6.4	Installation	27	4.3.1	Breaker-Controlled Ignition	43
2.1.3.2	Standard Clutch with Ring Spring	12	3.6.4.1	Installation with Heated Handles	30	4.3.2	Electronic Ignition	44
2.1.3.3	Quickstop Clutch (with Isolating Clutch)	12	3.6.5	Installation on 031 (030)	30	4.4	Spark Plug	45
2.1.4	Installation	13	3.6.5.1	Installation on 031 (030) with Heated Handles	30	4.4.1	Description of Operation	45
2.1.4.1	Standard Clutch	13	3.7	Crankcase, Crankshaft	31	4.4.2	Troubleshooting Chart	45
2.1.4.2	Quickstop Clutch (with Isolating Clutch)	13	3.7.1	Removal of Crankshaft	31	4.4.3	Checking and Cleaning Spark Plug	45
2.2	Chain Brake	14	3.7.1.1	Removal of Crankshaft (Heated Handles)	33	4.4.4	Installation of Spark Plug	46
2.2.1	Construction and Operation	14	3.7.2	Removal of Crankshaft - 031 (030)	34	4.5	Ignition Lead	46
2.2.1.1	Band Brake	14	3.7.2.1	Removal of Crankshaft on 031 (030) with Heated Handles	34	4.5.1	Description of Operation	46
2.2.1.2	Shoe Brake	15	3.7.3	Visual Inspection	34	4.5.2	Removal of Ignition Lead on 032 with Heated Handles	46
2.2.2	Troubleshooting Chart	15	3.7.4	Installation of Crankshaft	34	4.5.3	Removal of Ignition Lead 031 (030)	47
2.2.3	Disassembly and Repair	16	3.7.4.1	Installation of Crankshaft (Heated Handles)	35	4.5.4	Visual Inspection	47
2.2.3.1	Band Brake	16	3.7.5	Installation of Crankshaft - 031 (030)	36	4.5.5	Installation of Ignition Lead (Heated Handles)	47
2.2.3.2	Shoe Brake	17	3.7.5.1	Installation of Crankshaft on 031 (030) with Heated Handles	36	4.5.6	Installation of Ignition Lead - 031 (030)	47
2.2.4	Installation	18	3.8	Leakage Testing the Crankcase	36	4.6	Ground Lead	48
2.2.4.1	Band Brake	18	3.8.1	Pressure Test	37	4.6.1	Description of Operation	48
2.2.4.2	Shoe Brake	19				4.6.2	Checking the Ground Lead	48
3.	<b>Engine</b>	20						
3.1	Construction	20						
3.2	Troubleshooting Chart	20						
3.3	Exposing the Cylinder	21						



4.6.3	Exposing the Ground Lead	48	4.11	Contact Set	56	5.3	Removal of Rope Rotor	67
4.6.4	Exposing the Ground Lead - 031 (030)	48	4.11.1	Construction	56	5.3.1	Visual Inspection	67
4.7	Stop Switch	48	4.11.2	Description of Operation	56	5.3.2	Replacing the Starter Rope	67
4.7.1	Description of Operation	48	4.11.3	Replacing the Contact Set	56	5.3.3	Replacing the Rewind Spring	68
4.7.2	Checking the Stop Switch	48	4.11.4	Replacing the Contact Set - 031	57	5.3.3.1	Tensioning the Rewind Spring	68
4.7.3	Removal of Stop Switch	48	4.11.5	Replacing the Contact Set - 030	58	5.3.4	Starter Rope Guide Bush	69
4.7.4	Installation of Stop Switch	48	4.12	Trigger Plate	58	5.3.4.1	Replacing the Rope Guide Bush	69
4.8	Flywheel	49	4.12.1	Construction	58	5.4	Rewind Starter - 031 (030)	70
4.8.1	Description of Operation	49	4.12.2	Checking the Trigger Plate	58	5.4.1	Construction and Operation	70
4.8.2	Removal of Flywheel	49	4.12.3	Replacing the Trigger Plate	58	5.4.2	Troubleshooting Chart	70
4.8.3	Installation of Flywheel	50	4.12.4	Replacing the Trigger Plate - 031	59	5.4.3	Removal of Rope Rotor	71
4.8.4	Removal of Flywheel - 031 (030)	50	4.13	Ignition Timing	59	5.4.4	Visual Inspection	71
4.8.5	Installation of Flywheel - 031 (030)	50	4.13.1	Checking Breaker - Controlled Ignition	59	5.4.5	Replacing the Starter Rope	71
4.9	Ignition Armature	51	4.13.2	Adjusting Breaker - Controlled Ignition	60	5.4.6	Replacing the Rewind Spring	71
4.9.1	Construction	51	4.13.3	Checking Breaker - Controlled Ignition - 031	61	5.4.6.1	Tensioning the Rewind Spring	72
4.9.2	Resistance Test on Primary Winding	51	4.13.4	Adjusting Breaker - Controlled Ignition - 031	61	5.4.7	Replacing the Starter Rope Guide Bush	72
4.9.3	Resistance Test on Secondary Winding	51	4.13.5	Adjusting Breaker - Controlled Ignition - 031	62	5.5	Routine Maintenance	72
4.9.4	Testing with Ignition Coll Tester	52	4.13.6	Checking Electronic Ignition	63	5.6	Replacing the Pawls and Springs	72
4.9.5	Removal of Ignition Armature	52	4.13.7	Correcting Electronic Ignition	64			
4.9.6	Installation of Ignition Armature	53	4.14	Magneto Edge Gap	65	6.	<b>AV Handle System</b>	73
4.9.7	Removal of Ignition Armature - 031 (030)	54	4.14.1	Magneto Edge Gap - 031 (030)	65	6.1	Construction and Operation	73
4.9.8	Installation of Ignition Armature - 031 (030)	54				6.2	Replacing the Vibration Dampers	73
4.10	Condenser	54				6.2.1	Rear Handle	73
4.10.1	Description of Operation	54	5.	<b>Rewind Starter</b>	66	6.2.2	Handlebar	73
4.10.2	Checking the Condenser	54	5.1	Construction and Operation	66	6.2.3	Handle Frame	73
4.10.3	Replacing the Condenser	55	5.2	Troubleshooting Chart	66	6.3	AV Handle System - 031 (030)	73
4.10.4	Replacing the Condenser - 031 (030)	55				6.3.1	Replacing the Vibration Dampers	73



7.	<b>Electrically Heated Handles</b>	74	9.	<b>Fuel System</b>	82
7.1	Construction	74	9.1	Construction	82
7.2	Description of Operation	74	9.2	Operation of Fuel Pump	82
7.3	Troubleshooting	74	9.3	Operation of Carburetor	82
7.4	Component Parts	76	9.4	Troubleshooting Chart	84
7.4.1	Switch	76	9.5	Leakage Testing the Carburetor	86
7.4.2	Heating Element in Rear Handle	76	9.6	Removal of Carburetor	86
7.4.3	Heating Element in Handlebar	76	9.7	Repairing Fuel Pump	86
7.4.4	Generator	76	9.7.1	Removal	86
7.5	Heated Handles - 031	77	9.7.2	Visual Inspection	86
7.5.1	Construction and Operation	77	9.8	Repairing the Carburetor	87
7.5.2	Troubleshooting	77	9.8.1	Disassembly	87
7.5.3	Disassembly	77	9.8.2	Reassembly	88
			9.9	Repairing the Carburetor - 031 (030)	88
			9.10	Adjusting the Carburetor	89
8.	<b>Chain Lubrication</b>	78	9.10.1	Fine Adjustment of Carburetor	89
8.1	Construction	78	9.11	Adjusting the Carburetor - 031 (030)	89
8.2	Description of Operation	78	9.12	Fuel Line and Tank Vent	90
8.3	Troubleshooting Chart	79	9.12.1	Operation	90
8.4	Oil Tank/Tank Vent	80	9.12.2	Cleaning the Pickup Body	90
8.4.1	Construction and Operation	80	9.12.3	Removal and Installation of Hose	90
8.5	Pickup Body	80			
8.5.1	Removal and Installation, Repair	80	10.	<b>Air Filter and Choke Valve</b>	91
8.6	Valve	80	10.1	Operation	91
8.6.1	Removal and Installation	80	10.2	Removing and Cleaning the Filter	91
8.7	Oil Pump	81		Set of Special Tools	92
8.7.1	Removal	81		Set of Testing Tools	92
8.7.2	Disassembly of Oil Pump	81			
8.7.3	Assembly of Oil Pump	81			
8.7.4	Installation of Oil Pump	81			



## 1. SPECIFICATIONS — 032

<b>Engine</b>	Single cylinder two-stroke engine with specially processed cylinder bore.	
	Displacement:	51 cm <sup>3</sup>
	Bore:	45 mm
	Stroke:	32 mm
	Compression ratio:	9,5:1
	Power output:	2.6 kW (3.5 DIN HP) at 10,000 r.p.m.
	Max. torque:	3 Nm at 6,500 r.p.m.
	Max. permissible engine speed:	12,000 r.p.m.
	Mean idle speed:	2,200 r.p.m.
	Crankshaft:	two-part drop forging
	Crankshaft bearings:	2 deep-groove ball bearings
	Crankpin:	14.4 mm diam.
	Big-end bearing:	Needle cage
	Piston pin:	10 mm diam.
	Small-end bearing:	Needle cage
	Rewind starter:	Pawl engagement with automatic starter rope rewind mechanism
	Starter rope:	3.5 mm diam., 1060 mm long
Clutch:	Centrifugal clutch without linings, 69 mm diam.	
Clutch engages at:	3,200 r.p.m.	
Crankcase leakage test with overpressure:	0.5 bar	
with vacuum:	0.5 bar	
<b>Fuel System</b>	Carburetor:	All position diaphragm carburetor with integral fuel pump
	Adjustment:	
	High-speed adjustment screw H:	Open 1½ turns
	Low-speed adjustment screw L:	Open 1½ turns (basic setting with screws initially lightly against their seats)
	Carburetor leakage test with overpressure:	0.4 bar
	Fuel capacity:	0.53 liter
	Fuel mixture:	Regular grade gasoline and two-cycle engine oil Mix ratio 1:40 with STIHL two-cycle engine oil; 1:25 with other branded two-cycle engine oils
Air filter:	Large area, double sided flat wire mesh element	



**Ignition System****032 AV and 032 AVQ**

Type:	Breaker-controlled magneto ignition
Magneto edge gap:	4.7-8.5 mm
Air gap:	0.2-0.3 mm
Ignition timing:	2.1-2.3 mm before T.D.C.
Advance angle:	27-28°
Breaker point gap:	0.3-0.4 mm
Condenser:	Capacitance 0.15-0.19 $\mu$ F
Ignition armature:	Coil winding resistances
	Primary                      Secondary
	0.7-1.0 $\Omega$ 7.7-10.3 k $\Omega$

**032 AVE**

Type:	Transistor-controlled (breakerless) magneto ignition with automatic advance
Air gap:	0.2-0.3 mm
Ignition timing:	2.7 mm before T.D.C. at 8,000 r.p.m.
Advance angle:	30° at 8,000 r.p.m.
Ignition armature:	as 032 AV/032 AVQ

**All models**

Spark plug (suppressed):	Bosch WSR 6 F or Champion RCJ 6 Y Heat range 200 Electrode gap 0.5 mm Spark plug thread M 14 x 1.25, 9.5 mm long
--------------------------	---

**Tightening torques**

Crankshaft nut (ignition side) M 8 x 1:	30 Nm
Hub/clutch carrier (sprocket side):	40 Nm
M 5 socket head screws:	8 Nm
M 5 pan head screws:	5 Nm
M 4 pan head screws:	2.5 Nm
M 5 nuts:	5 Nm
Spark plug:	25 Nm



CHAIN DRIVE AND  
CHAIN BRAKE

SHOIFACHIDING  
NR 000 10 100

Chain and Chain  
Sprocket

STIHL Chain

STIHL Chain

STIHL Chain and Chain Sprocket

STIHL Chain

STIHL Chain

STIHL Chain and Chain Sprocket

### Cutting Attachement

Guide bars:

STIHL Duromatic guide bars with stellite-tipped nose.  
STIHL Rollomatic guide bars with sprocket nose.  
Both types with corrosion-resistant finish and induction hardened rails.

Bar lengths:

Duromatic 40, 45 and 50 cm  
Rollomatic 32, 37, 40 and 45 cm

Chain:

8.25 mm (0.325") Oilomatic  
Rapid-Micro  
8.25 mm (0.325") Oilomatic  
Rapid-Micro S

Chain sprocket:

9.32 mm (3/8") Oilomatic  
Rapid-Standard  
9.32 mm (3/8") Oilomatic  
Rapid-Standard S  
7-tooth for 3/8" pitch  
8-tooth for 0.325" pitch

Chain speed:

18.5 m/s at 8,500 r.p.m.

Chain lubrication:

Fully automatic speed-controlled oil pump with plunger; operative only when chain is running.  
Additional flow quantity control by means of adjusting screw.

Oil delivery rate:

10 cm<sup>3</sup> at 6,000 r.p.m.

Oil tank capacity:

0.31 liter

### Weights

Model:

AV/AVE/  
AVEW

AVQ/AVEQ/  
AVEQW

Dry powerhead less  
bar and chain:

5.6 kg

6.0 kg

Dry powerhead with  
32 cm bar and chain:

6.5 kg

6.9 kg

### Special Accessoires

STIHL repair kit 032

1113 900 5001

STIHL repair kit 030

1113 900 5000

and 031

Gasket set 032

1113 007 1051

Gasket set 031

1113 007 1050

**SPECIFICATIONS**  
**031 AV (030 AV)**

<b>Engine</b>	Displacement:	48 cm <sup>3</sup> (45 cm <sup>3</sup> )
	Bore:	44 mm (42 mm)
	Power output:	2.4 kW/3.2 DIN HP (2.2 kW/3.0 DIN HP) at 8,500 r.p.m.
	Max. torque:	2.85 Nm at 6,000 r.p.m.
	Rewind starter:	Two-pawl starter with automatic starter rope rewind mechanism
	Starter rope:	3.5 mm diam., 960 mm long
<b>Fuel System</b>	Carburetor setting:	
	High-speed adjustment screw H:	Open 1/4 turns
	Low-speed adjustment screw L:	Open 1/4 turns
<b>Ignition System</b>	Type:	Breaker-controlled magneto ignition
	Magneto edge gap:	3.5–7.5 mm
	Ignition timing:	2.0–2.3 mm before T.D.C.
	Ignition armature:	Coil winding resistance
		Primary            Secondary
		0.8–1.1 Ω        6.5–8.0 kΩ
	<b>031 AVE</b>	
	Type:	Transistor-controlled (breakerless) magneto ignition
	Magneto edge gap:	0.15–0.25 mm
	Ignition timing:	2.5 mm before T.D.C. at 8,000 r.p.m.
	Advance angle:	25° at 8,000 r.p.m.



## 2. CLUTCH, CHAIN DRIVE AND CHAIN BRAKE

### 2.1 Clutch and Chain Sprocket

#### 2.1.1 Construction and Operation

The transmission of power from the engine to the saw chain is effected via a centrifugal clutch. On "Quickstop" models (up to machine No. 6375950) the centrifugal clutch incorporates an isolating clutch which is actuated by the chain brake.

On the **standard clutch** the carrier screwed to the crankshaft is the clutch element which absorbs the torque and acceleration of the crankshaft. It is essential that the carrier is always tightened down to the specified torque load.

On **Quickstop models with an isolating clutch** the driving plate is the element which absorbs the torque and acceleration of the crankshaft and must, therefore, always be tightened down to the specified torque load. The clutch spider is supported on the hub of the driving plate by a plain bearing bush, but not connected to it in any other way. The release plate and locking ring are positively connected to the driving plate, but free to move radially.

When the chain brake is disengaged the release plate is moved radially into its normal position by the cam of the actuating lever, while the locking ring is moved into mesh with the lugs of the clutch spider by spring force. The engine torque is transmitted positively to the clutch spider in this way. To sa-

Top:  
Standard Clutch  
Bottom:  
Component parts of standard clutch

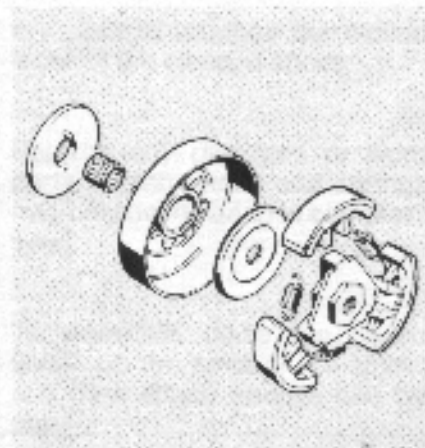
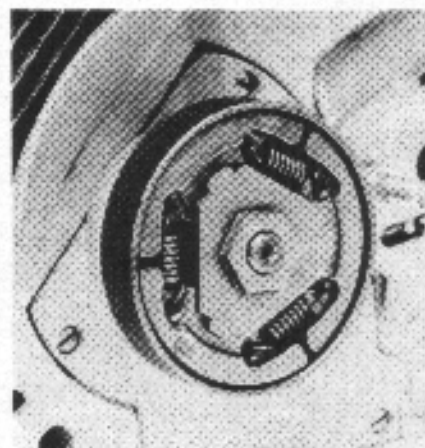

eguard against wear the shape of the locking ring and strength of the springs are designed so that the locking ring only engages below approx. 3,500 r.p.m. At higher speeds the centrifugal force of the asymmetric locking ring acts against the spring force - the locking ring does not engage.

When the chain brake is activated, the cam of the actuating lever disengages the release plate and thus the locking ring from the

Top:  
Isolating clutch  
Bottom:  
Component parts of isolating clutch

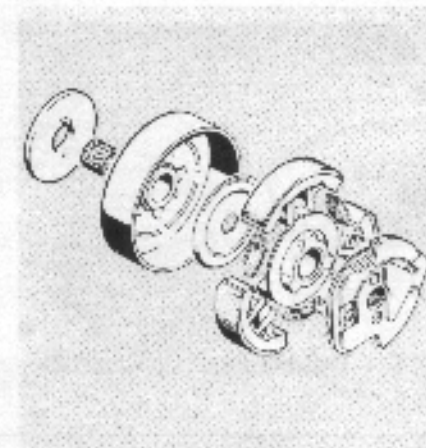
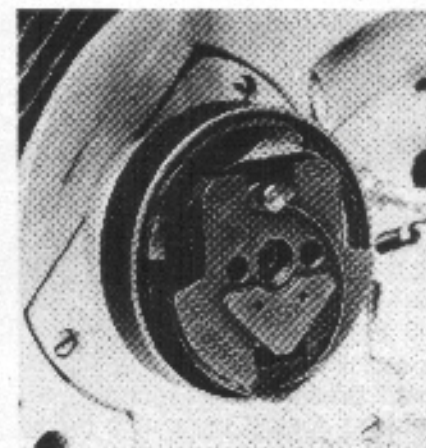

clutch spider. The clutch spider and driving plate can then rotate independently.

The centrifugal clutch has three clutch shoes; the clutch drum is rigidly connected to the chain sprocket.

When the engine is running at idle speed the clutch shoes are in a state of rest because the tension of the clutch spring(s) is greater than the centrifugal force. As engine speed increases the centrifugal force presses the clutch shoes outward against the clutch drum and thus transmit engine torque via

the clutch drum and chain sprocket to the saw chain.

The preload and strength of the clutch spring(s) are designed so that the clutch shoes begin to make contact with the clutch drum at an engine speed of approx. 3,200 r.p.m. (engagement speed). The clutch engages fully above this speed. It is therefore very important to set the carburetor to the correct idle speed in order to ensure that the clutch engagement

speed is not reached when the engine is idling.

### 2.1.2 Troubleshooting Chart

Condition	Cause	Remedy
Saw chain turns at idle speed	Engine idle speed too high	Readjust at idle speed adjusting screw
	Clutch spring(s) stretched or fatigued, spring hooks broken	Replace spring(s)
Isolating clutch does not engage when chain brake is released	Engine idle speed too high	Readjust at idle speed adjusting screw
	Locking ring, release plate or spring broken	Fit new locking ring, release plate or spring
Chain wears at high rate	Incorrect chain tension	Tension chain correctly



## 2.1.3 Disassembly and Repair

Disengage chain brake



Locking screw in position

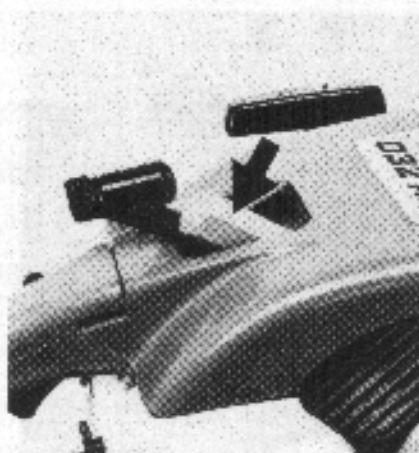

Top:  
Unscrew starter cover on 031  
Center:  
Unscrewing clutch spider  
Bottom:  
Refitting clutch shoes

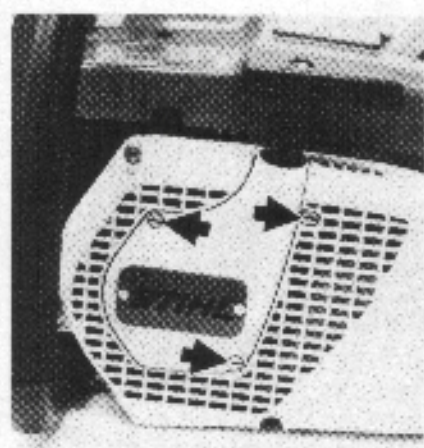

### 2.1.3.1. Standard Clutch with 3 Springs

First disengage the chain brake on Quickstop models and take off the sprocket cover, saw chain and bar. Remove the spark plug and fit the locking screw in its place – screw down by hand as far as it will go. On model 031 it is necessary to remove the starter cover as well.

Use a ring or socket wrench to release the clutch spider (left-hand thread – turn clockwise) and unscrew it from the crankshaft. Then take the support washer, chain sprocket with needle cage and cover plate off the crankshaft.

Pull the clutch shoes off the spider and detach the clutch springs. Wash out component parts of the clutch, including the clutch drum and the needle cage, in clean gasoline and blow out with compressed air, if available. If the clutch shoes have linings, use em-

ery cloth to roughen the friction faces of the cleaned shoes.

Replace any damaged or worn parts. Clutch shoes and springs may only be replaced **in complete sets!**

To assemble, place the clutch shoes on the arms of the spider and then attach springs one by one.

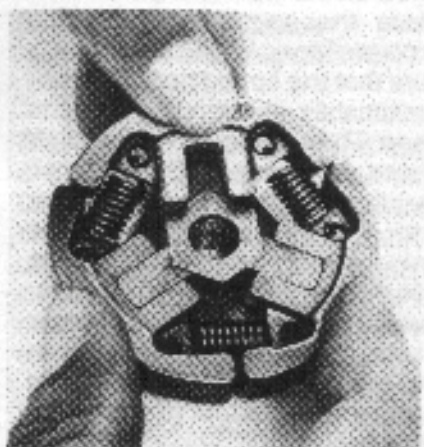
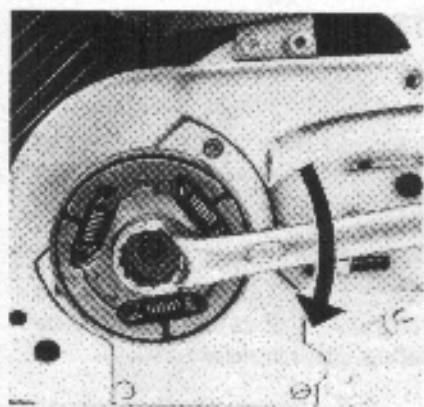

Standard clutch with ring spring

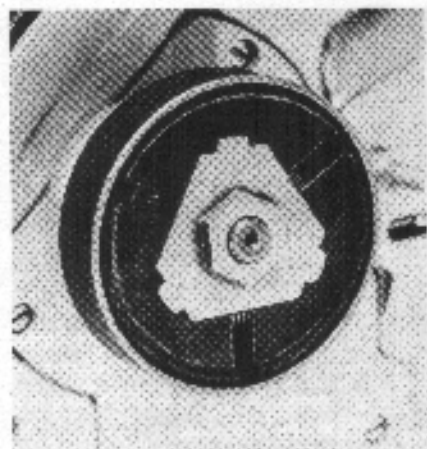

### 2.1.3.2 Standard Clutch with Ring Spring

Proceed as described under 2.1.3.2 for removal and disassembly.

Replace damaged or worn parts. The clutch shoes may only be replaced **in complete sets**.

To assemble, first hook the two ends of the spring together and place the spring in the spring groove of one clutch shoe, making sure that the spring hooks are approximately in the center of the shoe. Then place all three clutch shoes on the arms of the spider so that the spring grooves face away from the triangular plate on the spider. Now press the ring spring into the spring grooves of the other two clutch shoes with both your thumbs. Use a blunt tool to push the whole length of the spring down to the bottom of the clutch shoes.

Pressing ring spring into position

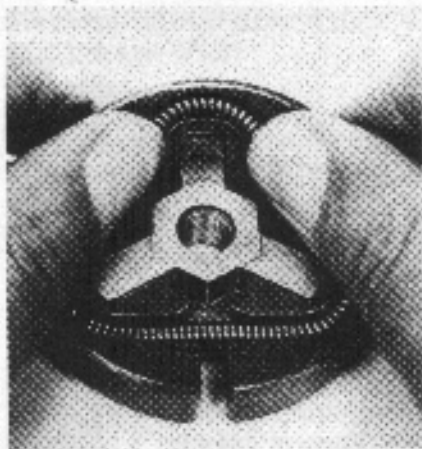

### 2.1.3.3 Quickstop Clutch (with Isolating Clutch)

First disengage the chain brake and take off the sprocket cover, chain and bar. Remove the spark plug and fit the locking screw in its place - screw down by hand as it will go. On model 031 it is necessary to remove the starter cover as well.

Use the face wrench to release the driving plate (left-hand thread - turn clockwise) and unscrew it together with the centrifugal clutch from the crankshaft.

The repair procedure is otherwise as described under 2.1.3.1.

Top:  
Unscrew starter cover on 031  
Center:  
Face wrench 11138903600  
Bottom:  
Releasing the driving plate

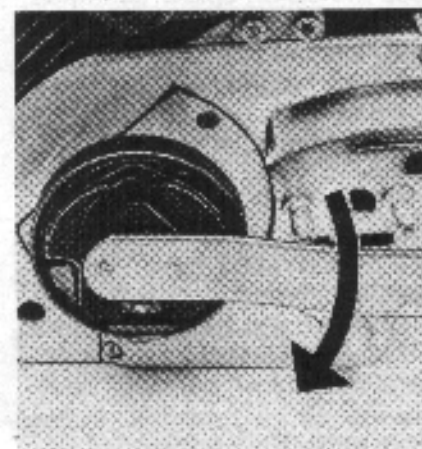
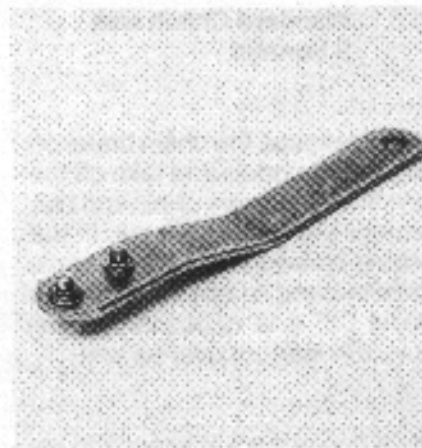
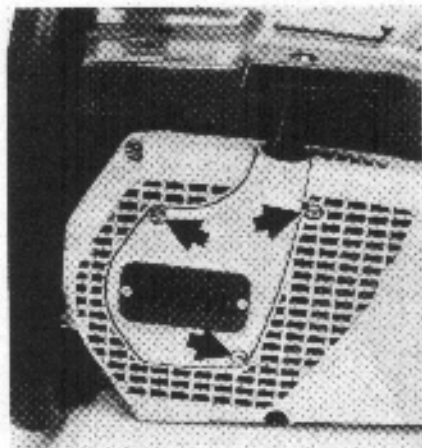



## 2.1.4 Installation

Top:  
Drive pin must engage in spur gear  
Bottom:  
Tightening the clutch spider

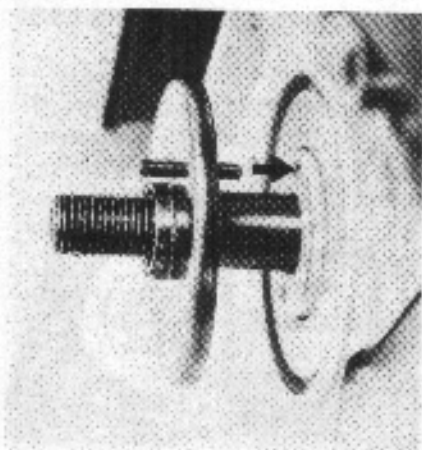

Fit chain sprocket on needle cage

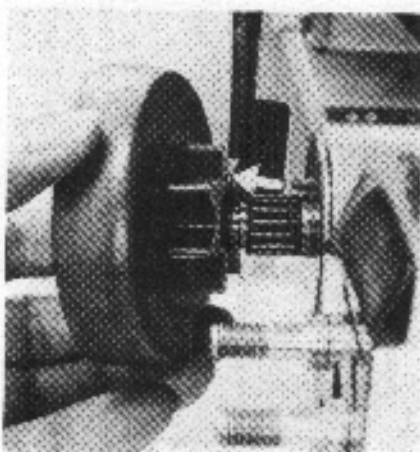

Top:  
Support washer correctly positioned  
Bottom:  
Fit clutch correctly on hub of spider

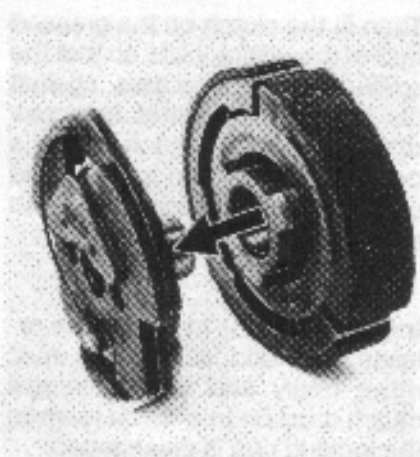
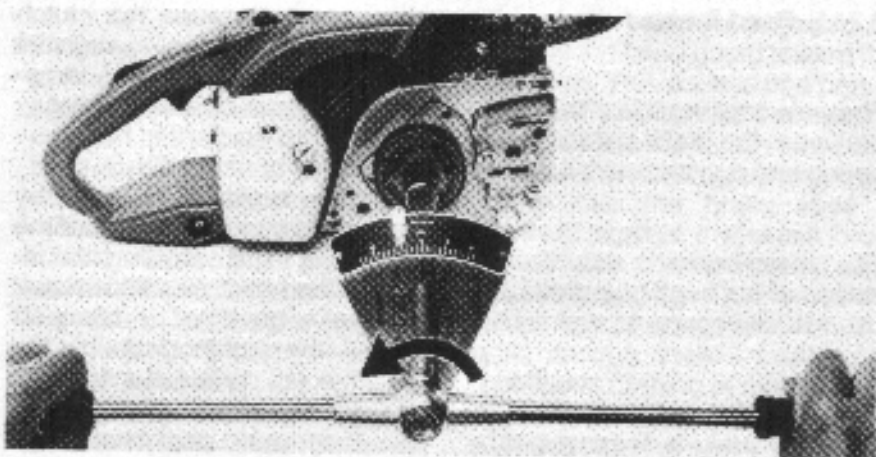
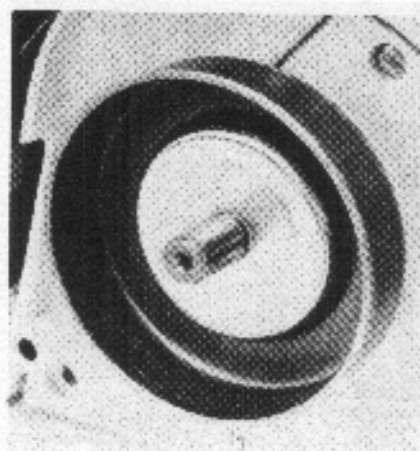

### 2.1.4.1 Standard Clutch

First fit the cover plate on the crankshaft so that the drive pin (bearing pin) for the oil pump drive engages in the spur gear. Lubricate needle cage with antifriction bearing grease and fit along with chain sprocket and support washer on the crankshaft.

Now screw clutch spider onto crankshaft (left-hand thread) so

that its triangular plate faces away from the crankshaft and tighten it down with a 19 mm ring or socket wrench to a torque load of 40 Nm.

Finish off by removing the locking screw, refitting the spark plug and sprocket cover. The starter cover must also be fitted on the model 031.

### 2.1.4.2 Quickstop Clutch (with Isolating Clutch)

First fit the cover plate on the crankshaft so that the drive pin (bearing pin) for the oil pump drive engages in the spur gear. Lubricate needle cage with antifriction bearing grease and fit along with chain sprocket and support washer on the crankshaft.

## 2.2 Chain Brake

### 2.2.1 Construction and Operation

Tightening the clutch spider

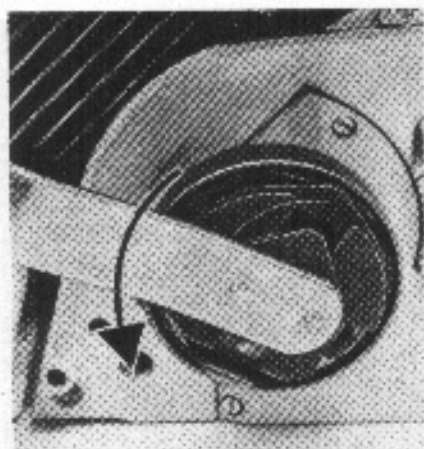

Then fit the clutch on the greased hub of the driving plate so that the spider's washer locates against the locking ring. Carefully screw driving plate with clutch onto the crankshaft (left-hand thread!) and use the face wrench to tighten down to a torque load of 40 Nm.

**Important:** Once installed, the release plate and locking ring must move freely and the centrifugal clutch must be free to rotate when the locking ring is disengaged.

Finish off by removing the locking screw, refitting spark plug and sprocket cover. The starter cover must also be fitted on the model 031.

Chain brake released

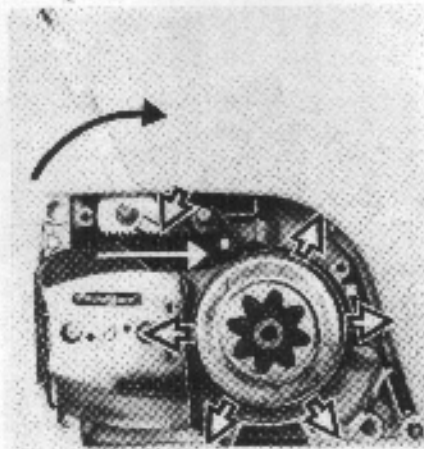

#### 2.2.1.1 Band Brake

The main components of this chain brake are the brake band, tension spring and a system of levers.

The chain brake is actuated by means of the hand guard which is used to disengage as well as engage the brake.

The **chain brake is disengaged** by pulling the hand guard back toward the handlebar. This movement is transmitted via a lever system which preloads the tension spring and releases the brake band. The brake lever, which is connected to the tension spring and brake band, is thus locked in the idle position by the relay lever and remains so even when the hand guard is released.

If the chain brake has been activated at full throttle, the throttle must be released immediately (back to

Chain brake engaged



idle speed) because the clutch shoes would otherwise run against the blocked clutch drum and generate excessive frictional heat.

The **chain brake is engaged** by moving the hand guard toward the bar nose. This movement unlatches the brake lever and causes the brake band to be clamped around the clutch drum by the force of the preloaded tension spring. The clutch drum (chain sprocket) and saw chain are brought to a standstill in a fraction of a second.



### 2.2.1.2 Shoe Brake

The main components of this chain brake are the brake shoe, compression springs and the actuating lever with cam – which controls the isolating clutch as well.

The chain brake is actuated by means of the hand guard which is used to disengage as well as engage the brake.

The **chain brake is disengaged** by pulling the hand guard back against the handlebar. This causes one part of the cam on the end of the actuating lever to lift the brake shoe off the clutch drum and the other part of the cam to move the rotating release plate into its normal position. This makes the isolating clutch engage (providing the engine is running at idle speed). The cam is locked in position by the brake shoe so that the hand guard can then be released.

Chain brake released

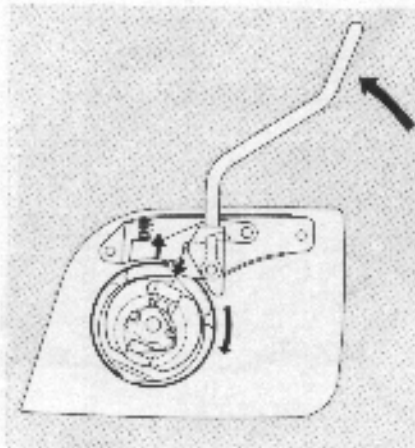

Chain brake engaged

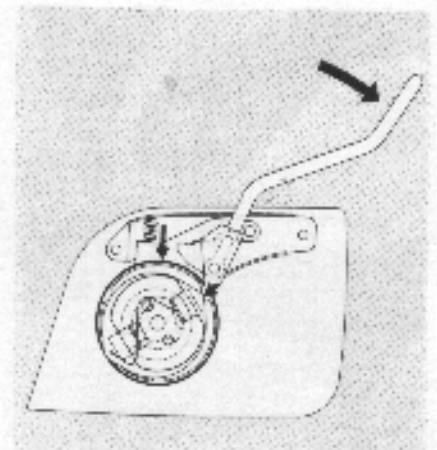

The **chain brake is engaged** by moving the hand guard toward the bar nose. This causes one part of the cam to displace the rotating release plate radially and thus disengage the isolating clutch. At the same time the brake shoe is pressed against the clutch drum by the force of the preloaded compression springs. This brings the chain sprocket to a standstill in a split second even if the engine continues running at high speed.

### 2.2.2 Troubleshooting Chart

Condition	Cause	Remedy
Saw chain does not stop immediately when chain brake is engaged	Brake spring(s) broken	Fit new brake spring(s)
	Brake band broken	Fit new brake band

## 2.2.3 Disassembly and Repair

## 2.2 Chain Brake

## 2.2.1 Construction and Operation

Top:  
Release chain brake  
Bottom:  
Engage chain brake on disassembled sprocket cover

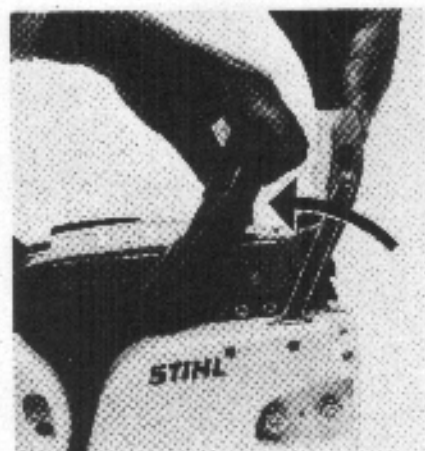

Top:  
Unscrew side plate and cover  
Bottom:  
Lever brake band out of its seat

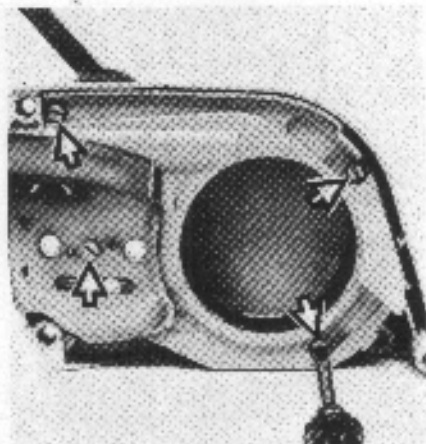

Top:  
Detaching brake band and tension spring  
Bottom:  
Removing retaining washers

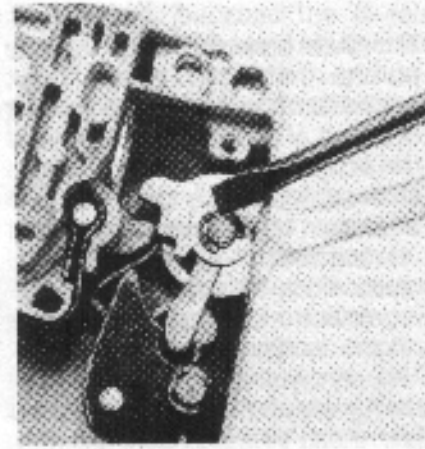
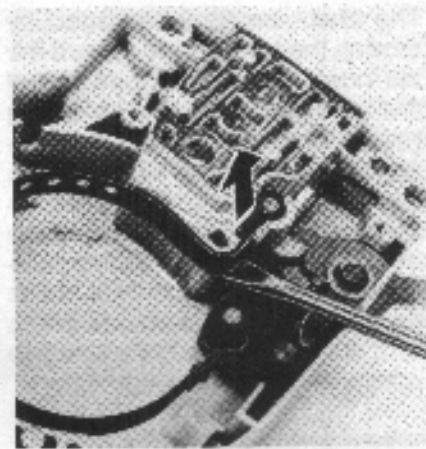
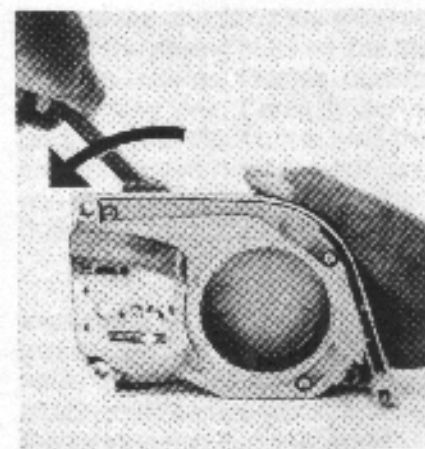
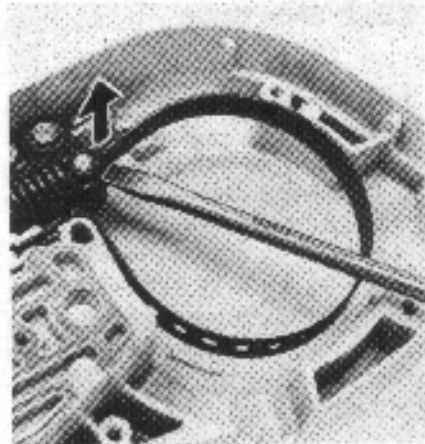

## 2.2.3.1 Band Brake

Release the chain brake by pulling the hand guard toward the handlebar and take off the sprocket cover. Then re-engage the chain brake and unscrew the side plate and cover.

Detach brake band and tension spring from the pivot pin.

Remove pin for tension spring from sprocket cover and withdraw the tension spring. Remove the retain-

ing washers and take off the actuating lever, relay lever and cam.

The brake band can now be levered out of its seat in the sprocket cover.

Wash all disassembled component parts in clean gasoline and inspect them for signs of wear. It is best to compare them against new parts.



Top:  
Release chain brake  
Bottom:  
Engage chain brake on disassembled sprocket cover



Top:  
Drive out notched pins  
Bottom:  
Unscrew cover plate

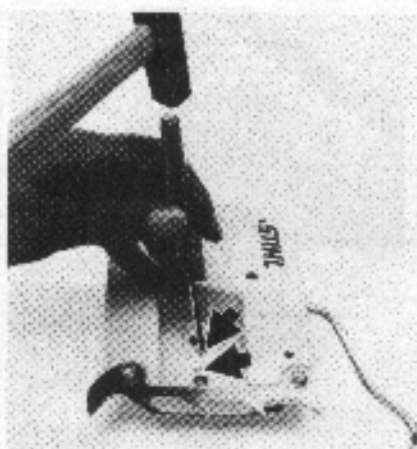

Top:  
Drive out pivot pin  
Bottom:  
Detach compression springs

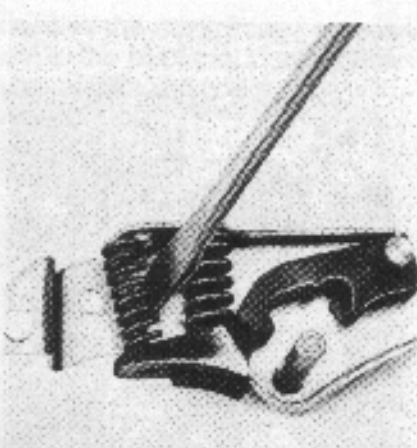
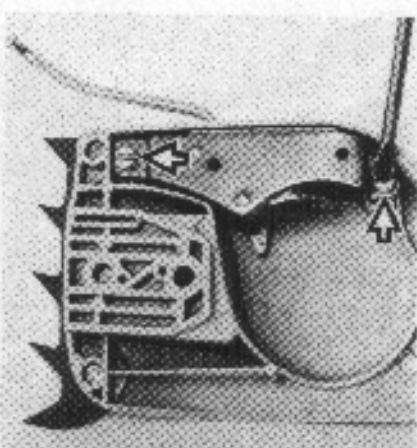
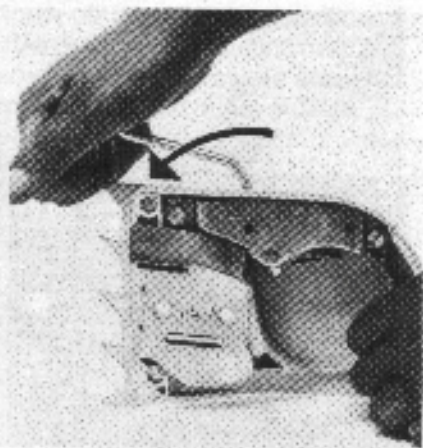
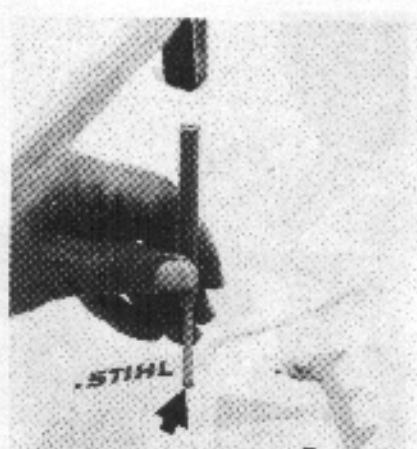

### 2.2.3.2 Shoe Brake

Release the chain brake by pulling the hand guard toward the handlebar and take off the sprocket cover. Then re-engage the chain brake so as to relieve the compression springs.

Use a suitable punch to drive out the notched pins which secure the outer side plate. Then remove the two screws which hold the cover

plate (they will be difficult to remove because they are secured with adhesive). Use a suitable punch to drive the cam's pivot pin - riveted to the cover plate - out of the sprocket cover, from the outside inwards. The cover plate can now be lifted off; the pivot pin slips out of the cam. Detach the compression springs and pull off the brake shoe.

Examine all disassembled parts for signs of wear - compare with new

parts where necessary. The brake shoe lining must have a minimum thickness of 1 mm or braking efficiency will otherwise be impaired.

## 2.2.4 Installation

Top:  
Actuating lever in position with pivot pin fitted  
Bottom:  
Tension spring and brake band fitted on cam

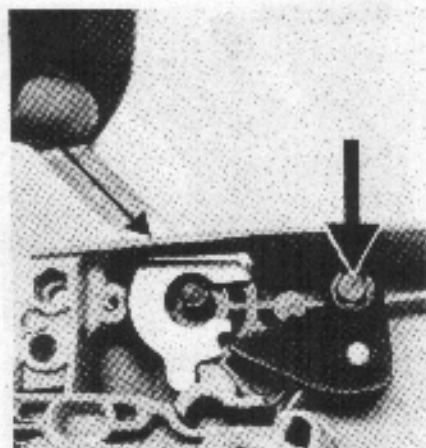

Top:  
Carefully drive retaining pin into loop  
Bottom:  
Fit tension spring in sprocket cover slot

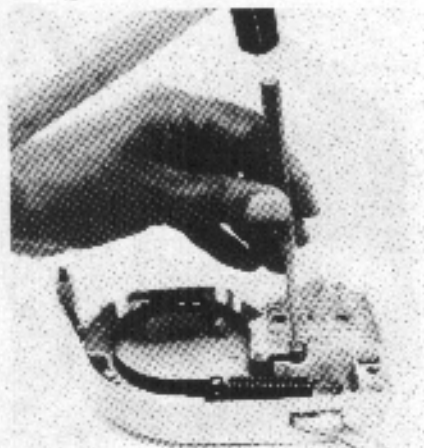

Top:  
Use a screwdriver to position tip of cam in notch  
Bottom:  
Relay lever correctly positioned

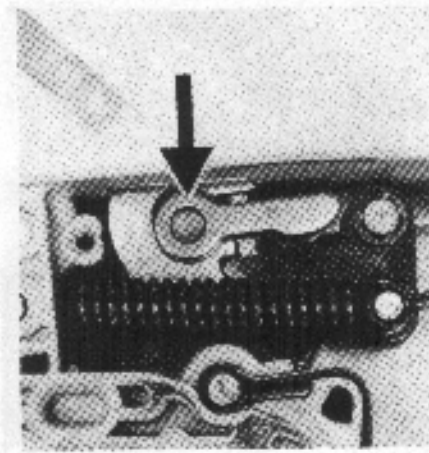
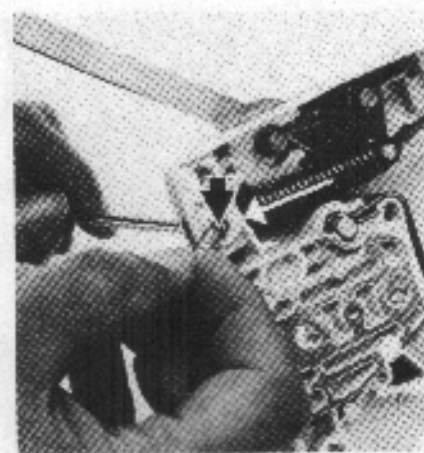
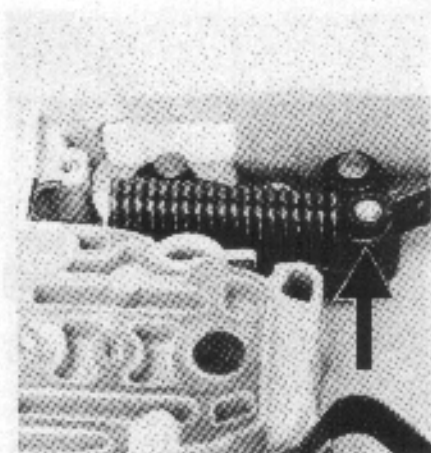
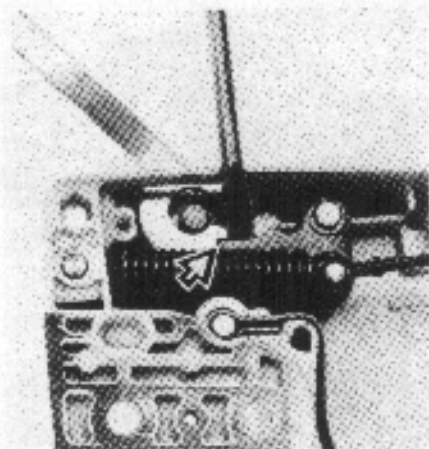

## 2.2.4.1. Band Brake

Insert actuating lever through slot in sprocket cover, grease the pivot pin and fit the cam so that its tip engages in the opening in the actuating lever. Fit the retaining washer on the cam pivot pin. Fit closed loop of tension spring in the slot in the brake band's loop and then slip both over the pin (lubricate with grease!) on the cam. At the same time engage the hook at the other end of the tension spring in the slot in the sprocket cover.

Then press the bent end of the brake band into its seat in the sprocket cover and carefully drive the retaining pin into the loop. Use a small screwdriver and insert it in the tension spring's pivot pin hole from the front of the sprocket cover and push the spring loop forward up to the edge of the hole. Fit the pivot pin in the hole from the inside and push it in until the spring loop engages in the groove.

Use a screwdriver to turn the cam against the spring until its tip engages the notch in the actuating lever; the cam is thus locked in this position for the time being. Now push the relay lever over the pivot pin and line it up by hand so that it can be pressed into its seat in the actuating lever.

Then fit plain and retaining washers on the relay lever's pivot pin. Coat friction faces of cam and relay lever with ample grease.



Actuating lever assembled

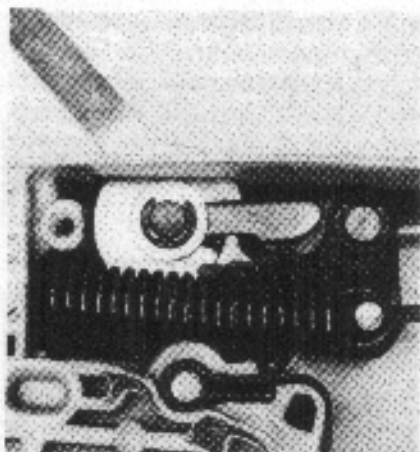

Finish off by checking function of chain brake; refit plastic cover and side plate as well as the sprocket cover. The chain brake must be released before the sprocket cover can be fitted.

Top:  
Brake shoe in position  
Bottom:  
Compression springs correctly  
positioned

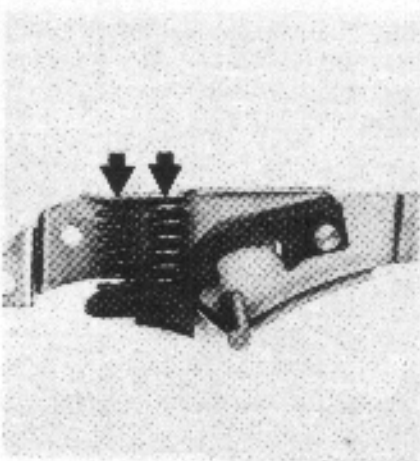

#### 2.2.4.2 Shoe Brake

Slip the brake shoe over the short pivot pin (lubricate with grease first!). Fit the large diameter compression spring outside and the other spring inside between the cover plate and brake shoe.

Then push the cam onto the pivot pin in the cover plate (lubricate with grease first!) so that the cam which controls the brake shoe en-

Cam engages in recess

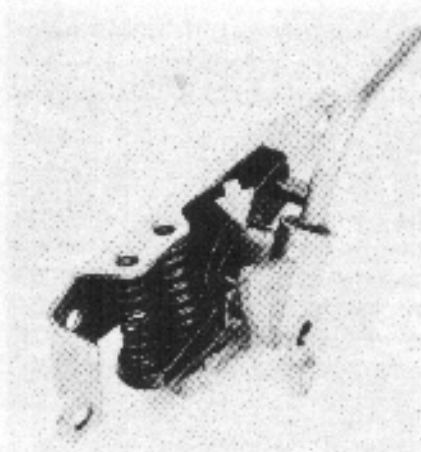

gages in the semicircular recess next to the pivot pin. Coat friction faces of cam and brake shoe with ample grease.

Now insert the actuating lever through the slot in the sprocket cover, locate the pivot pins on the cover plate in their respective holes and use a hammer to drive home the cam pivot pin until it is flush with the front side of the sprocket cover. Coat cover mounting screws with adhesive 0786111109 (LOCTITE 270 or 73), insert them and tighten down securely.

Finish off by refitting the side plate, checking the function of the chain brake and mounting the sprocket cover. The chain brake must be released before the sprocket cover can be fitted.

## 3. ENGINE

## 3.1. Construction

Model 032 and 031 (030) chain saws are powered by an air-cooled, single cylinder two-stroke engine.

The crankcase is a two-part pressure die casting made of a special magnesium alloy. The two-piece, drop-forged crankshaft is supported in two-ball bearings. Two oil seals, in the crankcase at the igni-

tion side and in the ball bearing at the sprocket side, hermetically seal the crank chamber.

The connecting rod, also drop-forged, is supported in needle cages on both the crankpin and the piston pin. Once the needle cage and the connecting rod have been fitted, the two halves of the crankshaft are pressed together to

form a torsionally rigid assembly and then machine finished. For this reason **a replacement crankshaft can only be supplied complete with connecting rod and needle cage.**

The cylinder and piston are made of a special aluminium alloy. The cylinder bore is coated on a special process.

## 3.2 Troubleshooting Chart

Check fuel system, carburetor, air filter and ignition system before looking for faults in the engine.

Condition	Cause	Remedy
Engine does not start easily, stalls at idle speed, but runs normally at full throttle	Oil seals in crankcase leaking	Replace oil seals
	Manifold leaking	Seal or replace manifold
	Crankcase damaged (cracks)	Replace crankcase
Engine does not deliver full power or runs erratically	Secondary air seepage into engine through poorly mounted or faulty manifold	Mount manifold correctly or replace
	Piston rings leaking or broken	Replace piston rings
Engine overheats	Insufficient cylinder cooling. Air inlets in fan housing blocked or cylinder cooling fins clogged with dirt	Thoroughly clean all cooling air passages



### 3.3 Exposing the Cylinder

See Chapter 1.2

Top:  
Unscrew slotted nut on carburetor  
box cover  
Bottom:  
Uncrew slotted nuts on air filter

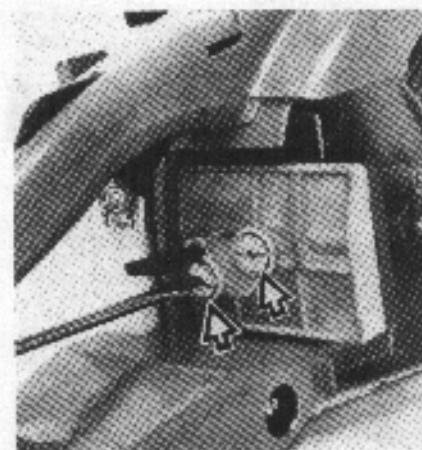
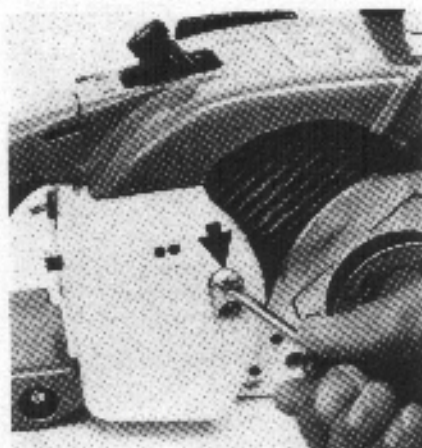

Disassemble the sprocket cover, cutting attachment and fan housing. (Disengage the chain brake on Quickstop models.)

Unscrew the slotted nut on the carburetor box cover and take off the carburetor box cover.

Remove both slotted nuts on the air filter and pull off the air filter.

Top:  
Remove retaining washer and  
disconnect throttle rod  
Bottom:  
Remove carburetor mounting nuts

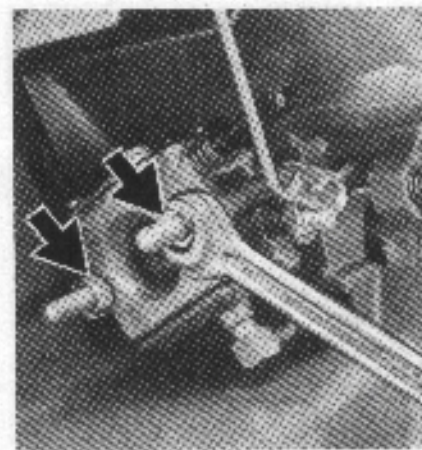
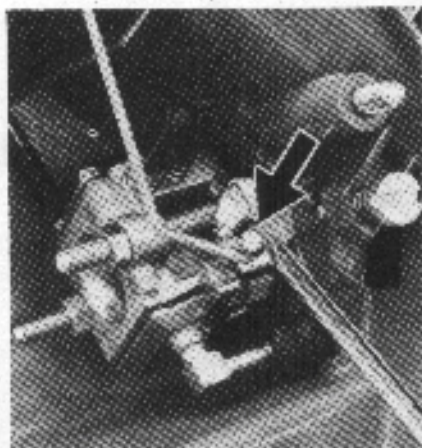

Press the retaining washer out of the groove in the throttle shaft and disconnect the throttle rod.

Unscrew the two mounting nuts from the carburetor studs. Pull the carburetor off the studs but use pliers to hold the impulse hose securely in its housing slot. Take off the fuel hose. Remove shim on right-hand stud and take sleeve out of manifold. Push the manifold and the impulse hose into the space

3.4 Exposing the Cylinder  
(3-330)

Top:  
Pull off carburetor, hold impulse hose  
securely  
Bottom:  
Take out shim and sleeve

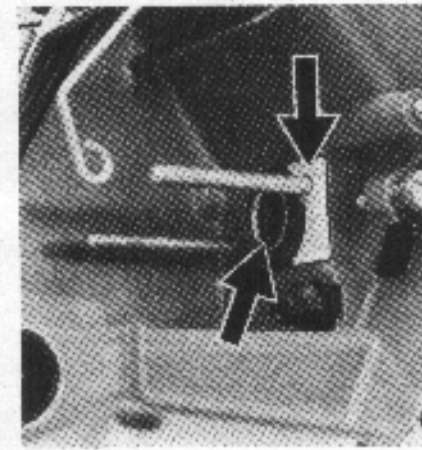
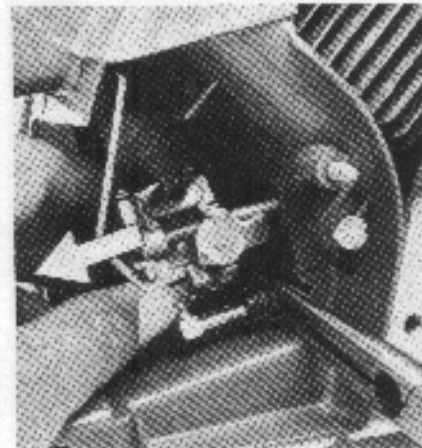

between the cylinder and handle frame.



Top:  
Push manifold and impulse hose  
inwards  
Bottom:  
Unscrew handlebar

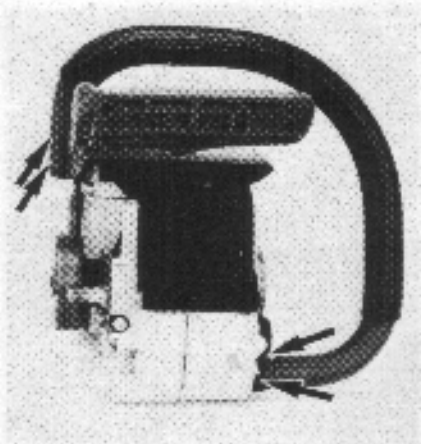
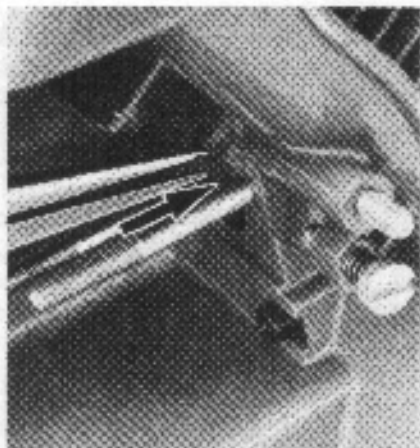

Unscrew handlebar at handle frame and crankcase.

Remove the two collar screws in the handle frame (rear vibration dampers) and one collar screw at the annular buffer.

Pull the fuel hose off the elbow connector. The elbow connector is behind the fuel filler cap.

Top:  
Remove collar screws from handle frame  
Bottom:  
Pull fuel hose off elbow connector

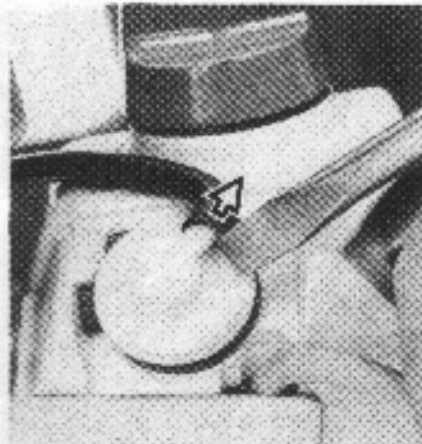

Take off the handle frame.

Remove the socket head screw(s) securing the muffler cover. Separate the muffler cover from the casing by tapping lightly with a plastic-faced hammer.

Unscrew the muffler casing at the cylinder exhaust port. The socket head screw on the crankcase is located directly above the front collar screw.

Top:  
Unscrew muffler cover  
Center:  
Split muffler cover and casing  
Bottom:  
Unscrew muffler casing

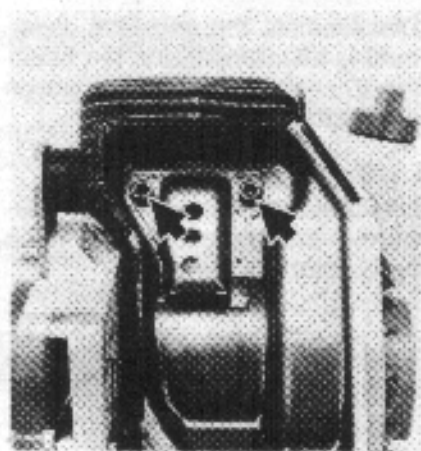
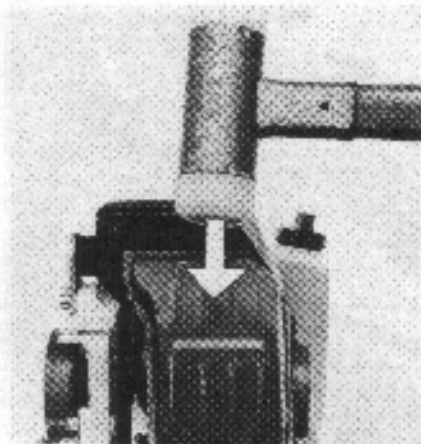
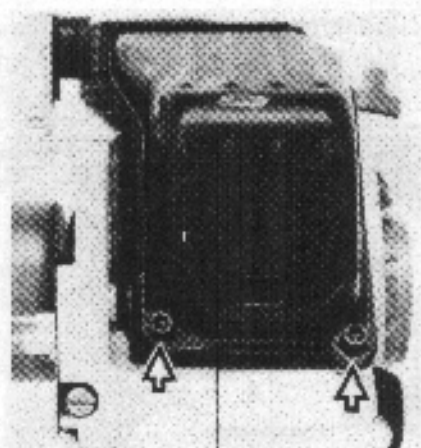



### 3.3.1 Exposing the Cylinder (Heated Handles)

See Chapter 3.3

Top:  
Remove handle cover retaining screw  
Bottom:  
Unscrew ground wire

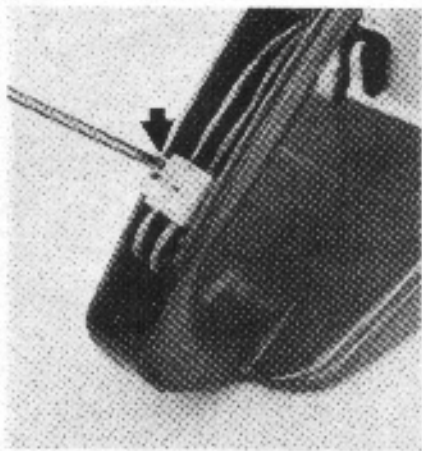
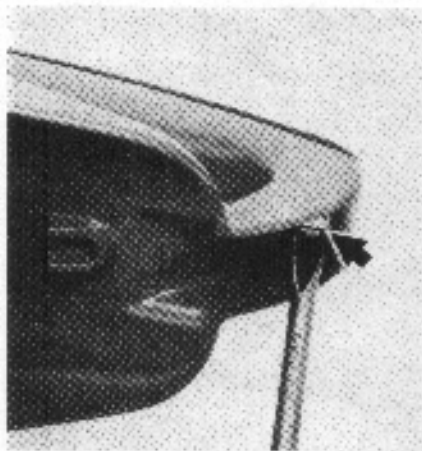

#### Difference

Unscrew the handle cover retaining screw and remove the handle cover and lever (safety throttle lock).

Disconnect the ground wire at the terminal strip.

Remove the nut on the stop switch.

Unscrew nut on stop switch

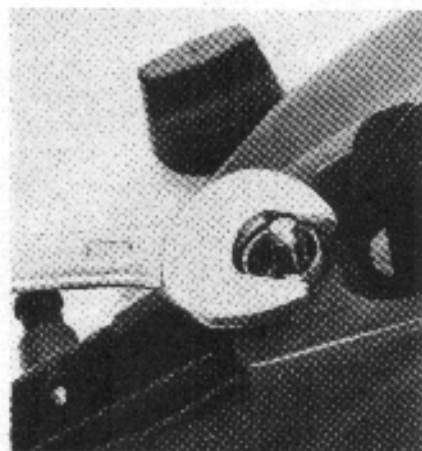

Take off the handle frame and handlebar. Handlebar is still connected to leads of electric handle heating.

### 3.4 Visual Inspection

Thoroughly clean dirt off the cylinder fins, especially in the cooling air intake area (fan housing).

Examine cylinder for broken cooling fins.

### 3.5 Exposing the Cylinder 031 (030)

Top:  
Remove slotted nuts from air filter  
Bottom:  
Remove retaining washer and  
disconnect throttle rod

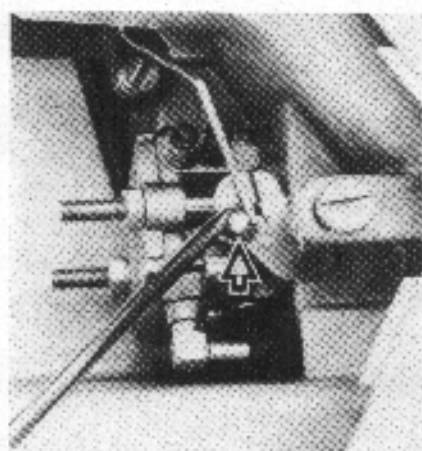
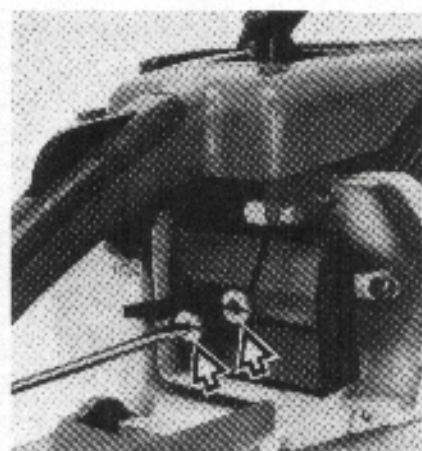

Disassemble the sprocket cover and cutting attachment. Take off the carburetor box cover.

Remove both slotted nuts from the air filter; pull off the air filter, press off the retaining washer and disconnect the throttle rod.

Top:  
Unscrew handlebar  
Bottom:  
Remove collar screws from vibration dampers

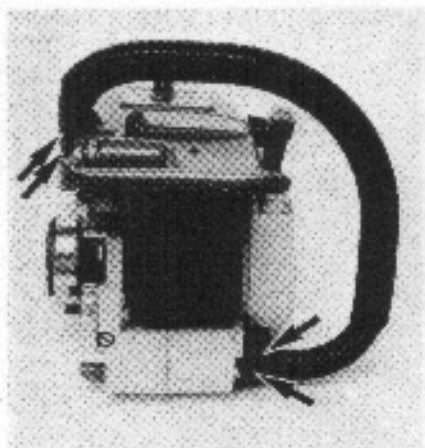

Top:  
Remove pan head screws from carburetor box cover  
Bottom:  
Unscrew carburetor mounting nuts

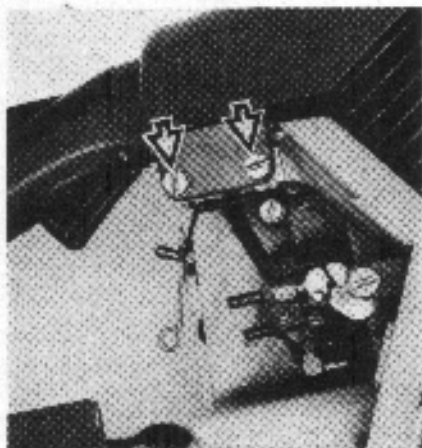

Top:  
Take off carburetor and hold impulse hose securely  
Center:  
Take sleeve out of muffler  
Bottom:  
Take off carburetor box cover and pull out impulse hose

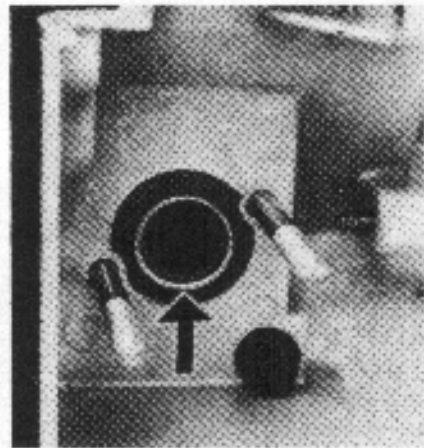
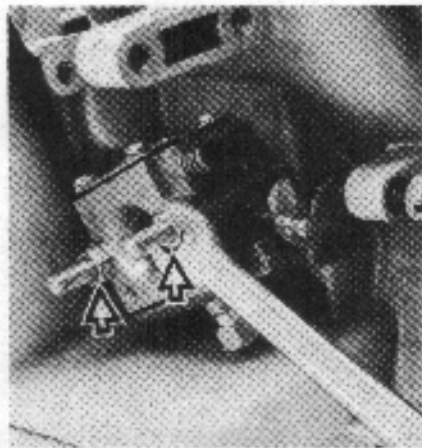
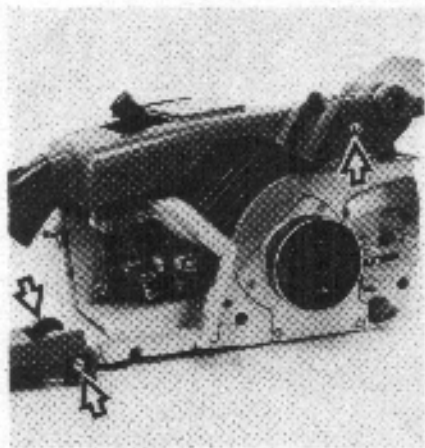
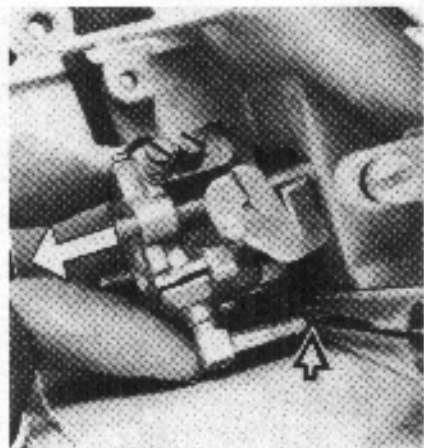

Unscrew the handlebar at the handle frame and crankcase and remove. Take out the two collar screws in the handle frame (rear vibration dampers) and one collar screw at the front annular buffer. Unscrew handle frame at carburetor box cover (three pan head screws); lift off the handle frame.

Unscrew the two carburetor mounting nuts from the studs. Pull carburetor off the studs while holding the impulse hose firmly in position with a pair of pliers.

Pull off the fuel hose.

Take the sleeve out of the manifold. Push the manifold into the space between the cylinder and carburetor box. Take off the carburetor box and pull the impulse hose off the connector on the crankcase at the same time.

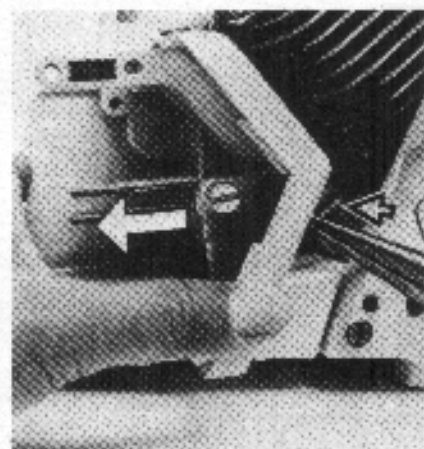



Top:  
Pull short circuit lead out of stop switch  
Bottom:  
Remove pan head screws from fan housing

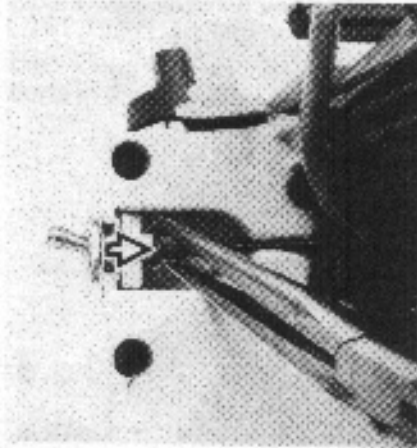

Top:  
Unscrew pan head screw at sprocket side  
Bottom:  
Unscrew muffler from cylinder

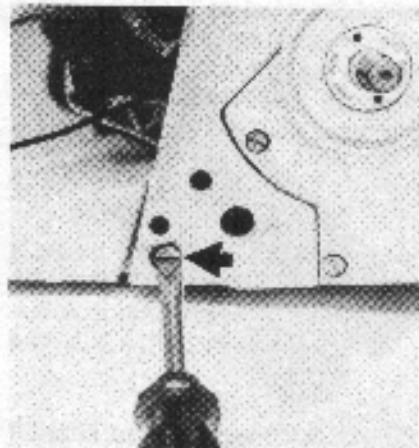

Unscrew muffler from crankcase

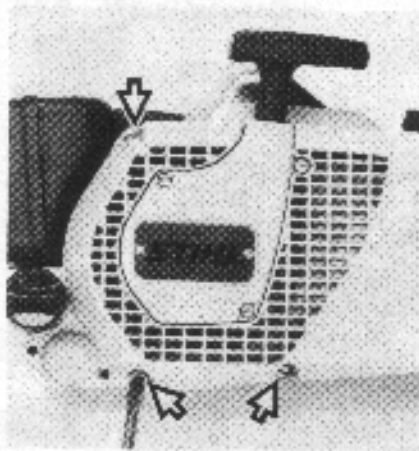
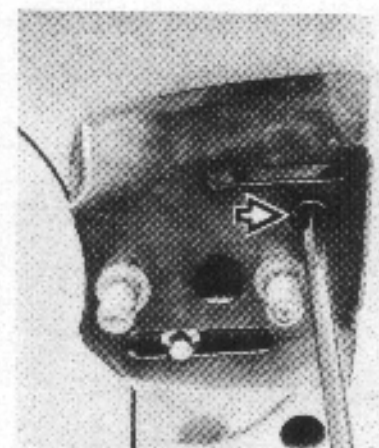

Pull off short circuit lead at the stop switch. Disassemble the fan housing and tank housing. To do this, unscrew 3 pan head screws at the fan housing side and 1 pan head screw at the sprocket side.

Unscrew the muffler at the cylinder exhaust port and crankcase. The pan head screw on the crankcase is located directly above the front collar screw.

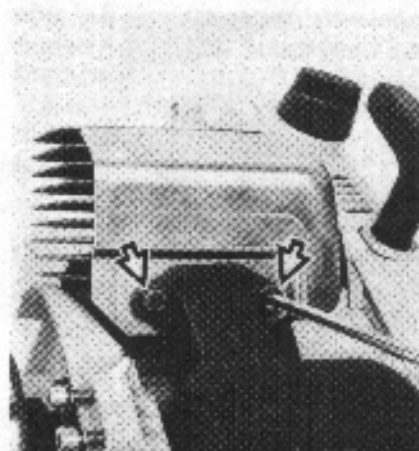

Take off the muffler with air guide plate.

### 3.5.1 Exposing the Cylinder - 031 (030) Heated Handles

See Chapter 3.5

#### Difference

The flexible heating tube is located about 40 mm down inside the handlebar. Take care when removing the handlebar that the heating tube is not torn away.

The clamp at the transition point between the valve and muffler must be unscrewed and the valve pushed off the muffler connection before the handle frame is removed.

## 3.6 Cylinder and Piston

### 3.6.1 Removal

Top:  
Unscrewing the cylinder  
Bottom:  
Release clamp on manifold

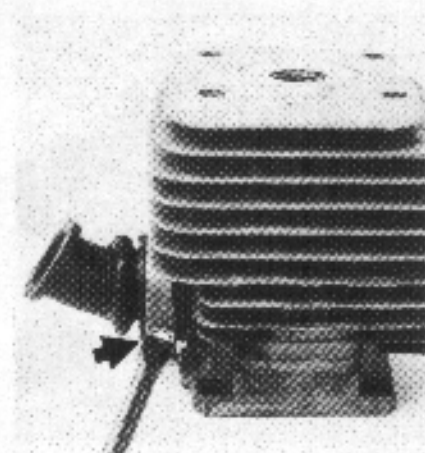
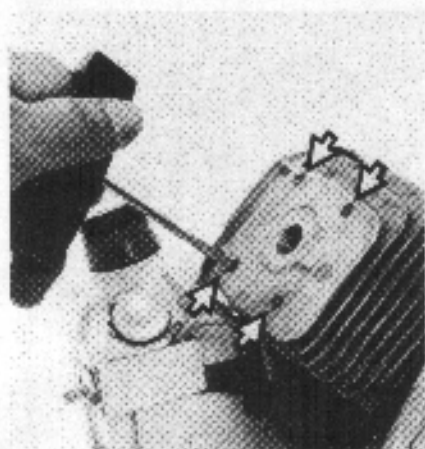

Top:  
Wooden assembly block  
1108 893 4800  
Bottom:  
Lock crankshaft with wooden assembly  
block

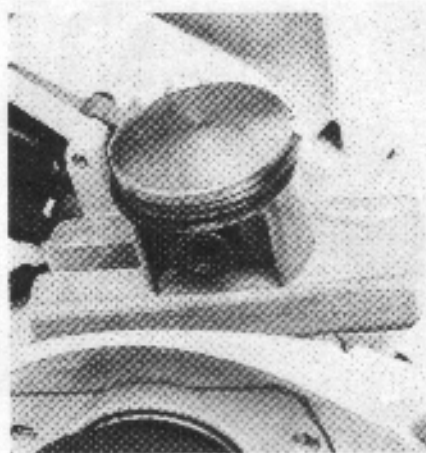
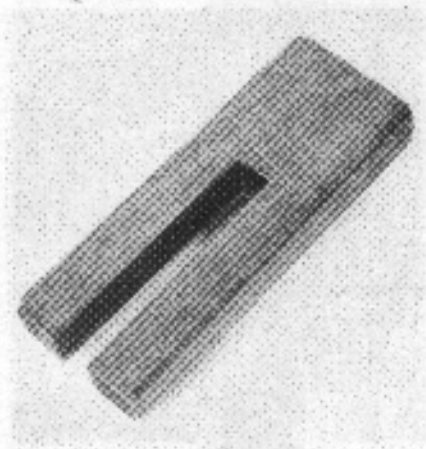

Top:  
Removing wire retainers  
Bottom:  
Pushing out piston pin with drift  
1110 893 4700

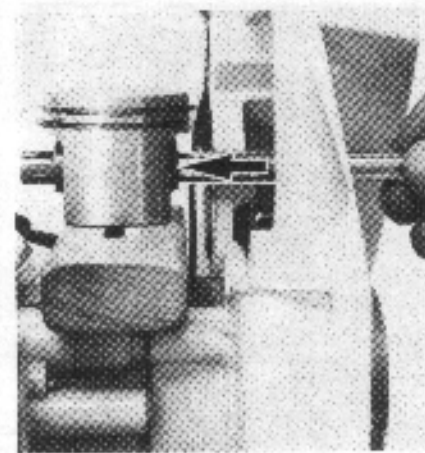
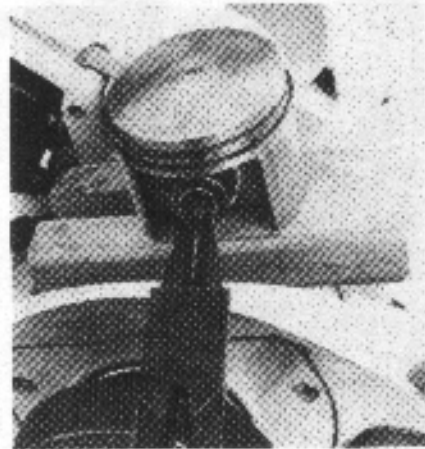

Preparations – see 3.3 or 3.3.1.

Detach the spark plug terminal and unscrew the spark plug. Remove the four socket head screws which secure the cylinder. Pull the cylinder off the piston. Release the clamp on the manifold sufficiently for the clamp to be removed over the manifold. Take manifold off cylinder intake port.

Before removing the piston it must be decided whether or not the

crankshaft is to be removed as well. This is important because the wooden block has to be fitted between the crankcase and piston in order to lock the crankshaft for removal of the flywheel and clutch.

Take out the wire retainers. Use the drift to push out the piston pin out of the piston and needle cage. If the piston pin is stuck as a result of carbonization of the piston boss, tap it out lightly with a hammer. It is essential to counterhold the piston

to ensure that no jolts are transmitted to the connecting rod.

#### 3.6.1.1 Removal, Heated Handles

See Chapter 3.6.1 and preparations in chapter 3.3.1.



**3.6.2 Removal on 031 (030)**  
See Chapter 3.6.1 and preparations in chapter 3.5.

### 3.6.4 Installation

**3.6.2.1 Removal on 031 (030) with Heated Handles**  
See Chapter 3.6.1 and preparations in chapter 3.5.1.

If the cylinder has to be replaced, the new cylinder must always be installed with a matching piston. Replacement cylinders are only supplied complete with matching pistons.

If only the piston is to be renewed on the 032 it is possible to use any replacement piston (marked "B") with any cylinder.

Pistons and cylinders of model 031 AV (030 AV) were previously available in 5 size groups with the letter codes A to E and subdivided into the 3 main groups A-B, C-D and E. The size group code is stamped on the piston crown and cylinder head.

For reasons of rationalization these groups were reduced to cylinders A, B and C with piston B and cylinders D and E with piston C. The pistons B and C can be installed in all cylinders of their respective groups.

Arrow and "A" point towards exhaust port

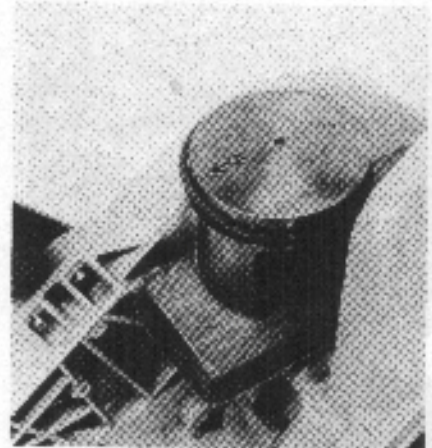

Coat the needle cage with oil and insert it in the piston boss. Place new cylinder gasket on the crankcase - cutouts face intake port. Position piston on connecting rod so that the arrow and "A" stamped on the piston crown point towards the cylinder exhaust port.

### 3.6.3 Visual Inspection

Examine the piston. Piston rings must move freely and not stick in their grooves. If the edges of the piston rings are worn round, fit new rings. Inspect small end needle cage. Make sure that manifold is in good condition.

Check cylinder bore. In the case of excessive wear and deep scores, fit a new cylinder.

**Table - 031 (030)**

Previous version for new cylinders		Previous version for broken-in cylinders		Simplified system	
Piston	for cylinder	Piston	for cylinder	Piston	for cylinder
A	AB	A	AB	-	-
B (AB)	BC	B	ABC	B	ABC
C (CD)	CD	C	BCD	C	DE
D (E)	DE	D	CDE	-	-
E	E	E	DE	-	-

Fit piston pin  
on assembly drift

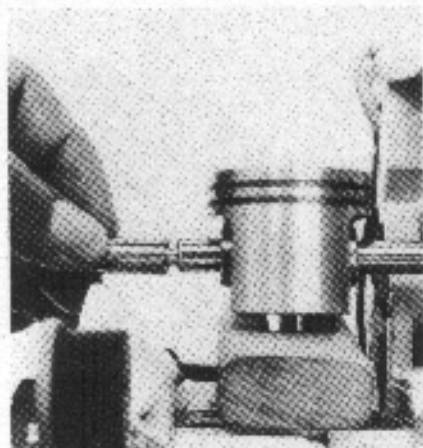

Fit the piston pin in the piston and connecting rod. To do this, push assembly drift through the piston bore and the connecting rod to align both bores concentrically. Fit piston pin on the spigot of the assembly drift and slide it into the piston. Gently move the piston to and fro to easy insertion of the piston pin.

Light thumb pressure is all that should be required to install the piston pin. Do not use any force during assembly. Fit the two wire retainers and make sure they are properly seated in their grooves.

In the case of a new cylinder or if the manifold is faulty, it is necessary to fit the manifold before mounting the cylinder.

Push the manifold on to the intake port; it must point upwards (towards cylinder head) and the molding seam should be vertical (parallel with the cylinder axis).

Top:  
Wire retainer fitted  
Bottom:  
Manifold correctly positioned on  
intake port

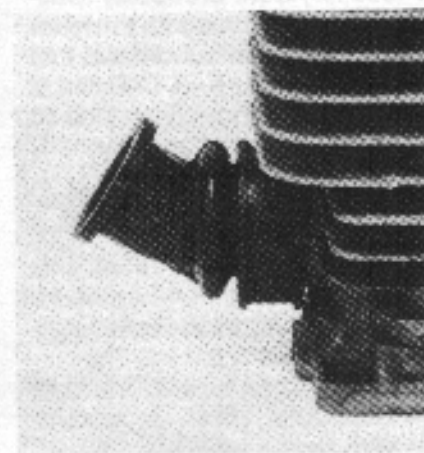
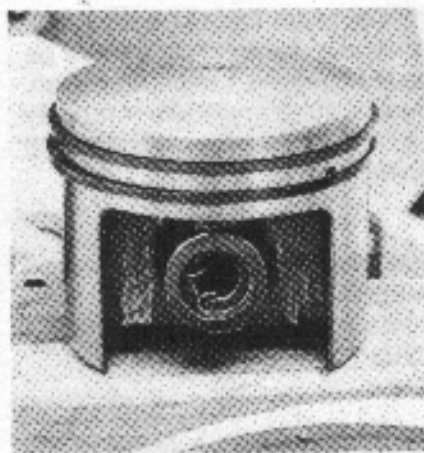

Attach and secure the hose clamp.

Make sure that manifold is correctly seated and properly sealed. Coat piston and its rings with engine oil (do not use old oil for this purpose).

Place the wooden assembly block on the crankcase so that the piston is resting on it. Turn the piston rings in their grooves so that the radii at the ring gaps locate (when the

Top:  
Clamp in position  
Bottom:  
Piston rings correctly  
positioned

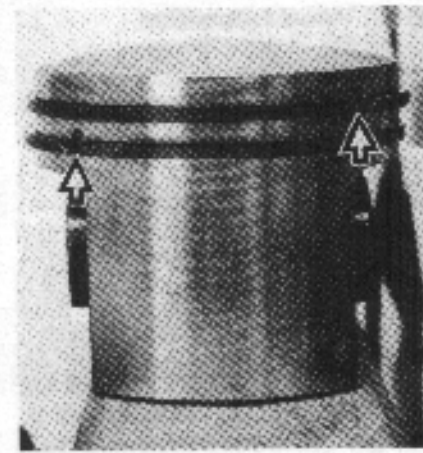
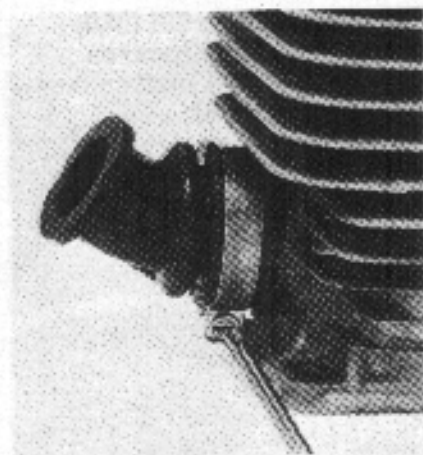

rings are compressed) against the fixing pins in the grooves.

Insert four M5x18 socket head screws (with captive washers) in the cylinder mounting holes. Use the clamping strap to encircle and compress the piston rings around the piston, but ensure they do not move out of position in the process.



Top:  
4 socket head screws in position  
Bottom:  
Clamping strap  
0000.89.3.2600

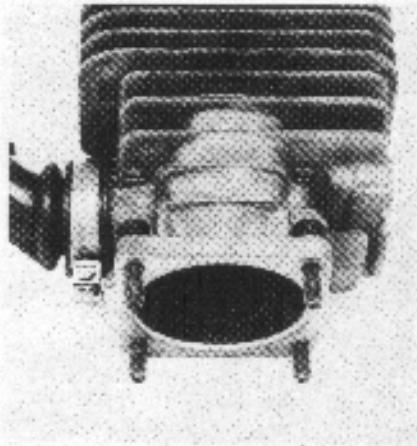

Top:  
Compress piston rings  
Bottom:  
Fitting the cylinder

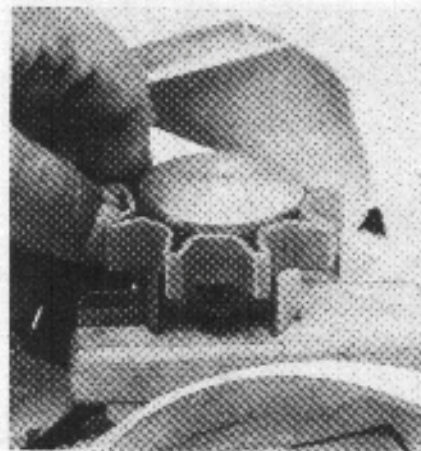

Tightening cylinder base screws

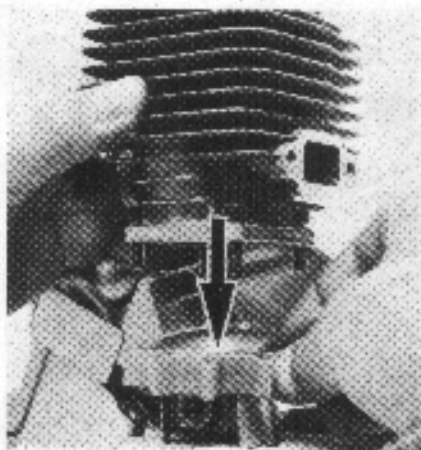
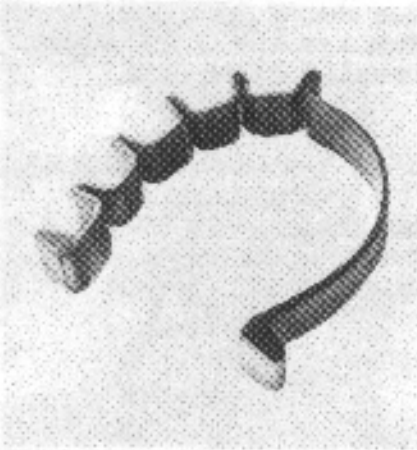
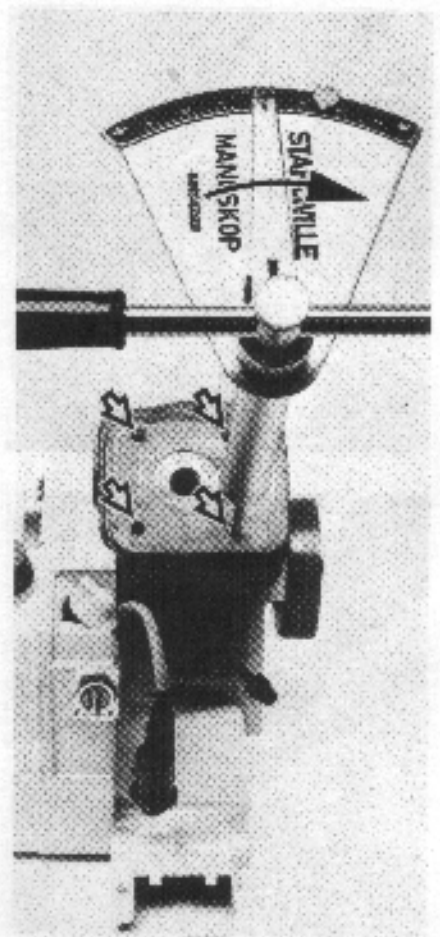

Fit the cylinder over the piston with the exhaust port facing in the direction of the bar nose. The cylinder must be exactly aligned in its normal installed position. If this is not done there is a risk of the piston rings breaking!

Take off the clamping strap and the wooden assembly block. Line up the gasket and cylinder. Screw down the cylinder base screws and tighten them in a diagonal pattern to a torque load of 8 Nm.

Assembly is then a reversal of the sequence in chapter 3.3.

**Note:** The M 5 x 16 screws used on early machines (before machine No. 5 090 200) should be replaced by M 5 x 18 screws.

### 3.6.4.1 Installation with Heated Handles

See chapter 3.6.4

Top:  
Push fuel hose onto  
elbow connector  
Bottom:  
Connect ground wire  
to terminal strip



Top:  
Slot in stop switch must  
point to "0"  
Bottom:  
Safety throttle lock lever  
and leg spring position

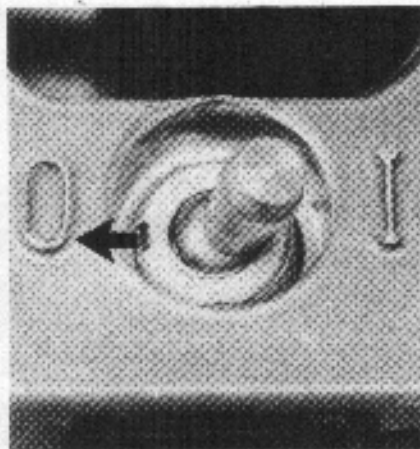

### 3.6.4 Installation on 031 (030)

Screw clamp 97710212540

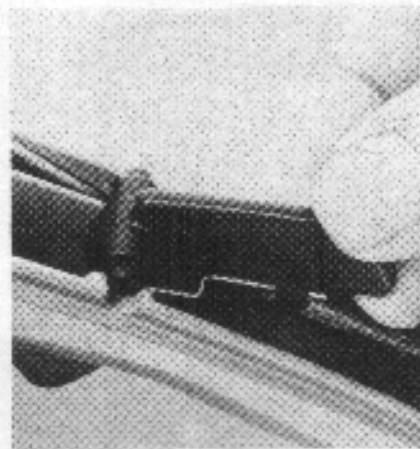
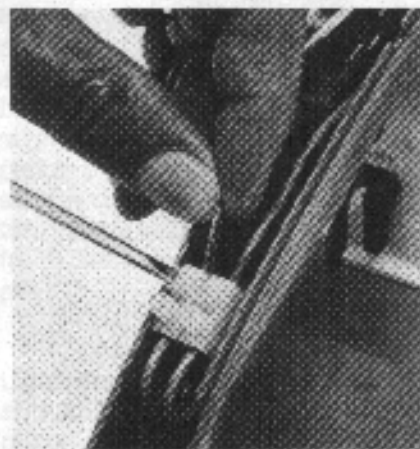
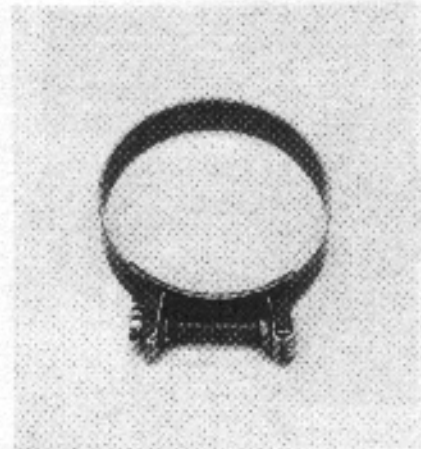

See chapter 3.6.4. Installation is then a reversal of the sequence described in chapter 3.5.

### 3.6.5.1 Installation on 031 (030) with Heated Handles

See chapter 3.6.4. Installation is then a reversal of the sequence described in chapter 3.5.1.

#### Difference

Fit handle frame together with the handlebar which is still connected to electric leads (tube); push the fuel hose onto the elbow connector at the same time.

Pull the ground wire through the opening in the handle frame and connect it to the terminal strip. Fit ground wire on the stop switch. Insert stop switch in the handle frame from below and secure in position with the nut.

#### Note:

The long slot in the thread must point to the "0" position.

Place safety throttle lock lever in position in the handle frame; the leg spring must also be located in the lever's groove. Fit and secure handle cover on handle frame.

**Note:** On machines before No. 4073060 a spring clip was used to secure the manifold. To avoid leaks in this area the spring clip should be replaced by screw clamp 97710212540.



### 3.7 Crankcase, Crankshaft

#### 3.7.1 Removal of Crankshaft

Top:  
Unscrew the stop switch  
Bottom:  
Unscrew ignition  
armature

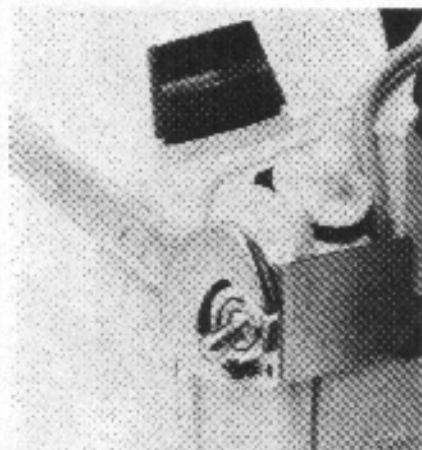

Top:  
Unscrew contact set  
with condenser and  
ground lead  
Bottom:  
Unscrew trigger plate  
and ground lead on  
electronic models

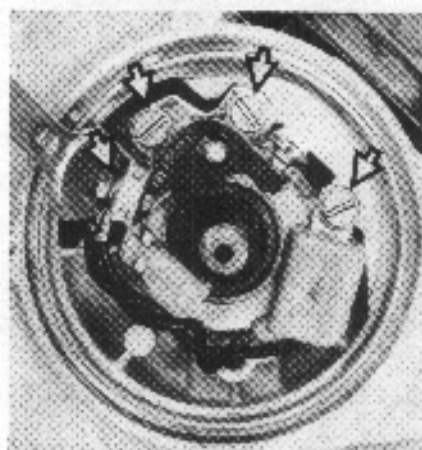

Top:  
Unscrew cover  
Bottom:  
Remove spur gear, worm  
and oil pump

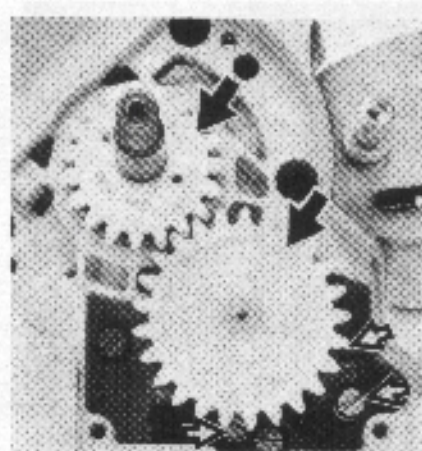
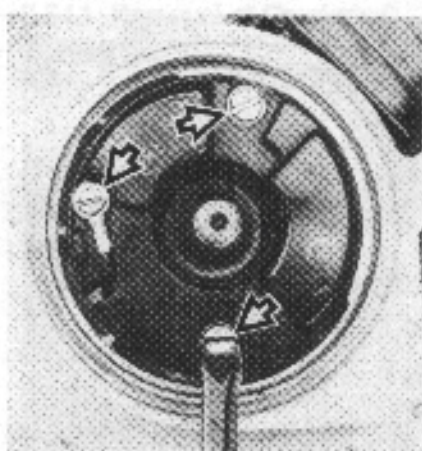
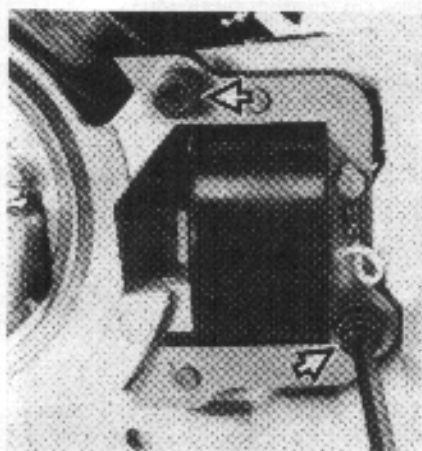
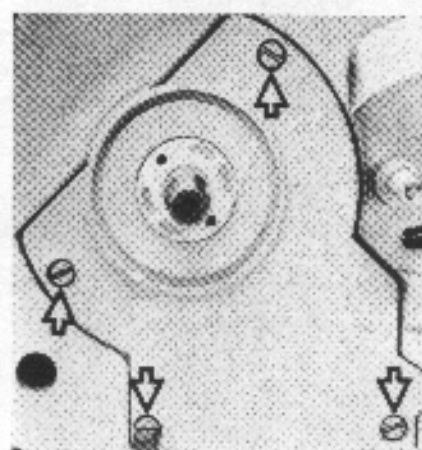

Drain the fuel and oil tanks, disassemble the clutch (2.1.3), expose the cylinder (3.3), remove the flywheel (4.8.2), remove the cylinder and piston (3.6.1), take off the cylinder gasket, unscrew the hexagon nut from the stop switch. Take off plate and cover plate. Unscrew the ignition armature. Unscrew the pan head screws, ground lead on contact set or trigger plate. Unscrew contact set with condenser. On machines with electronic ignition remove the trigger plate and take the ground lead out of the slot in

the trigger plate. Take off the ignition armature with ground lead, stop switch and ignition lead.

Unscrew the cover at the clutch side of the crankcase (8.7.1). Pull the spur gear, and the thrust washer behind it, off the crankshaft. Unscrew the worm from the oil pump by turning it clockwise. Unscrew oil pump from the crankcase. Take the crankcase off the assembly stand. Slip the M 8 stud wrench over the collar studs with

the splined face towards the side plate.

Use the collar nut to press the stud wrench firmly against the collar of the stud.

Remove both collar studs and the side plate. Remove the chain tensioning screw. Knock the two cylindrical pins back into the ignition side of the crankcase.



2.5.1 Installation of Crankcase  
 Sprocket  
 See Chapter 2.5.1

Top:  
 Stud wrench pressed firmly  
 against collar  
 Bottom:  
 Unscrew collar stud with  
 stud wrench

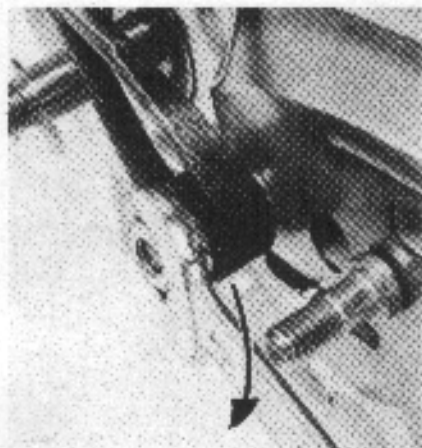

Top:  
 Knock back cylindrical  
 pins  
 Bottom:  
 Unscrew 7 pan head  
 screws

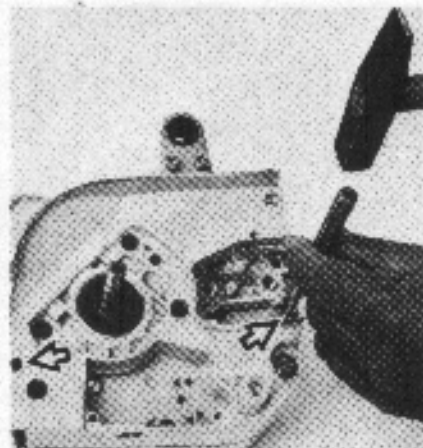

Top:  
 Removing key  
 Center:  
 Drive crankshaft out  
 of bearing  
 Bottom:  
 Knock out oil seals

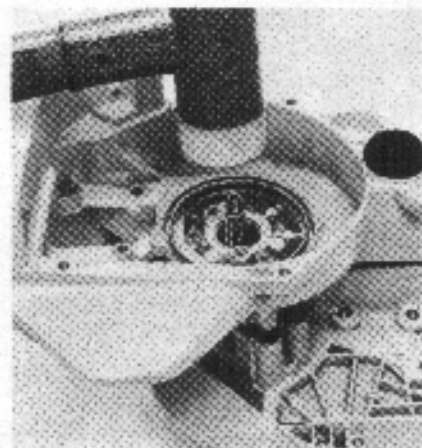
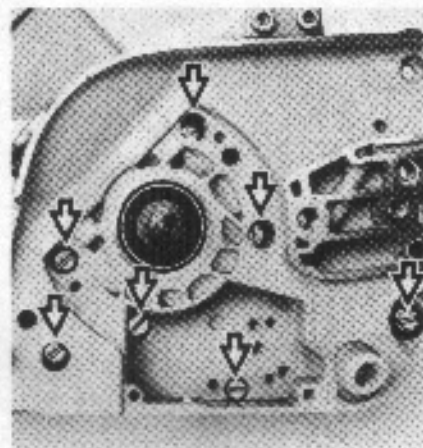
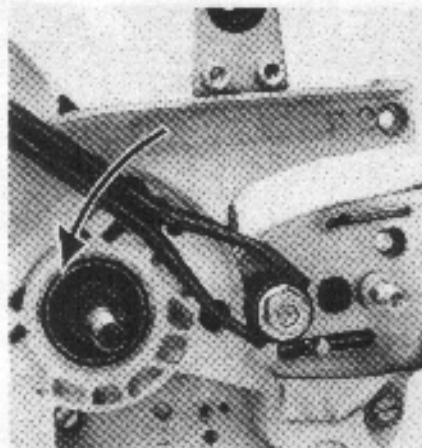
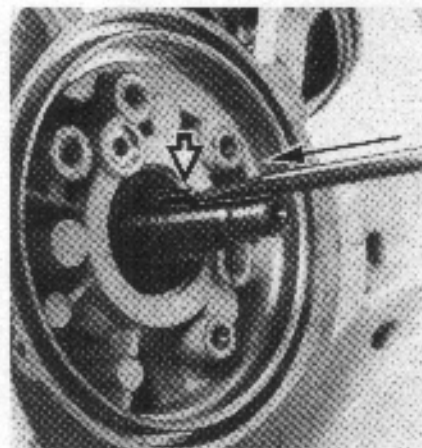

Unscrew the 7 pan head screws at the sprocket side. Hold the sprocket side of the crankcase and then split the two halves of the crankcase by tapping the crankshaft with a plastic-faced hammer.

Remove the key from the crankshaft, taking care not to damage the taper in the process.

Hold the ignition side of the crankshaft firmly and use the plastic-

faced hammer to drive the crankshaft out of the bearing.

Use a screwdriver to knock the oil seal out of the ignition side of the crankcase. Press the ball bearing out of its seat from the outside to the inside of the crankcase with press arbor 1118 893 7200.

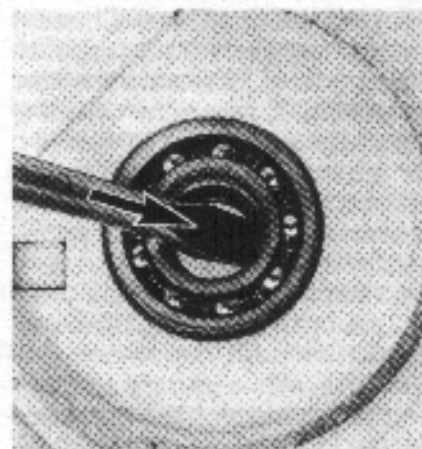



Top:  
Press arbor 1118 893 7200  
Bottom:  
Press out ball bearing at  
ignition side

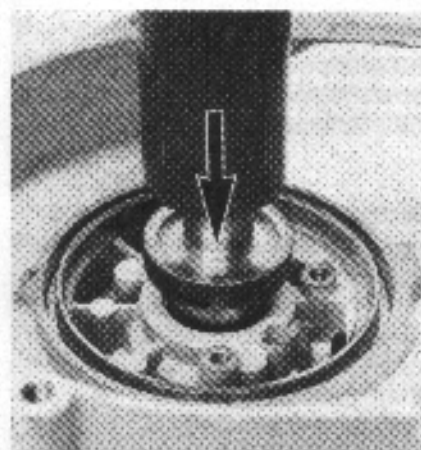
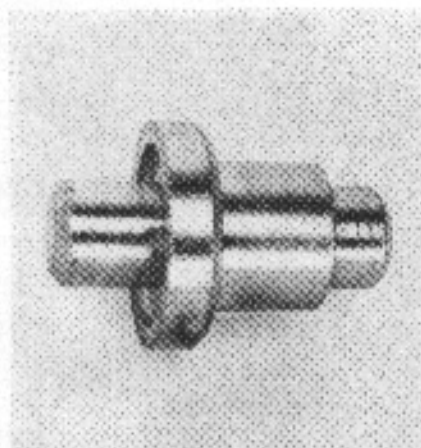

Press out the ball bearing at the clutch side with the assembly sleeve.

If only the oil seal is leaking, it can be removed and installed with the bearing in position. A screwdriver is used to lever it out of the bearing groove. It is installed with the special press sleeve for oil seals.

Press out ball bearing at  
clutch side

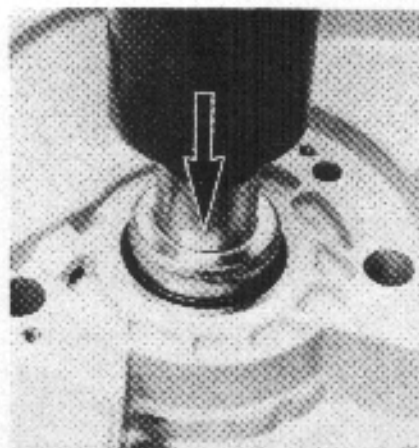

### 3.7.1.1 Removal of Crankshaft (Heated Handles)

Refer to chapter 3.7.1, plus the following:

Unscrew the ignition armature; take out two pan head screws and ground lead.

Remove the screw on the trigger plate. Press grommet out of crankcase and pull trigger plate out of the crankcase.

Unscrew the ground lead from the trigger plate. Take off the ignition armature with stop switch and ignition lead. Unscrew the generator; pull the ground wire through the housing. Unscrew the flange, it is centered on the crankcase and can be prised away with two screwdrivers.

Top:  
Unscrew trigger plate  
Center:  
Unscrew generator  
Bottom:  
Prise off flange

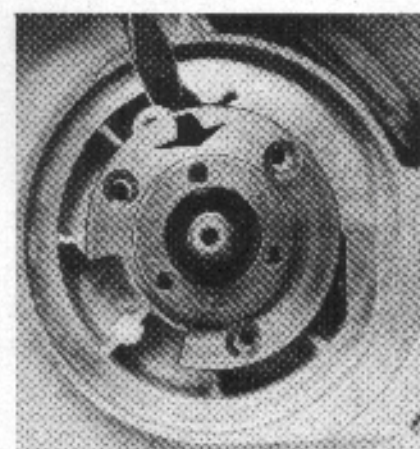
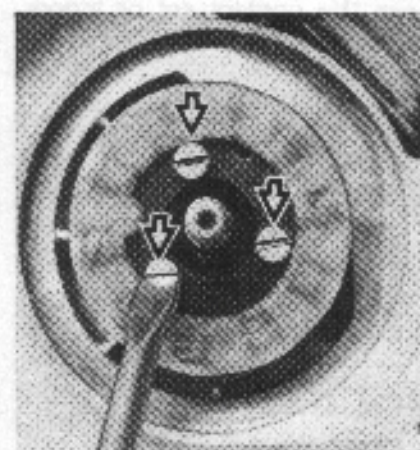
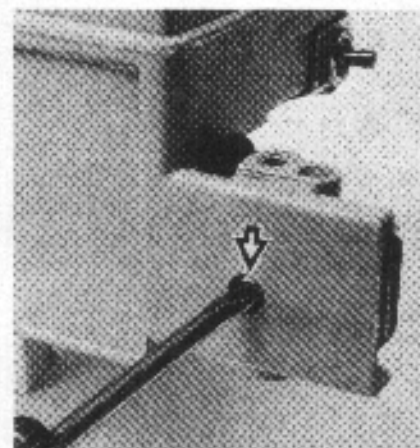

### 3.7.2 Removal of Crankshaft 031 (030)

Drain the fuel and oil tanks. Disassemble the clutch (2.1.3). Expose the cylinder (3.5), remove the flywheel (4.8.4).

Remove the cylinder and piston (3.6.2), take off the cylinder gasket. Unscrew the ignition amature. Unscrew the ground and primary leads at the contact set. On machines with electronic ignition unscrew the ground and primary leads at the trigger plate. Pull both leads along with the weatherproof grommet out of the crankcase bore. Remove the contact set or trigger plate.

Disassembly procedures are otherwise as described in chapter 3.7.1.

#### 3.7.2.1 Removal of Crankshaft on 031 (030) with Heated Handles

See chapters 3.7.2 and 3.5.1

#### 3.7.3 Visual Inspection

Examine the big end bearing. If it is faulty the complete crankshaft will have to be replaced. Inspect parts of crankcase for cracks.

### 3.7.4 Installation of Crankshaft

Snap ring in position

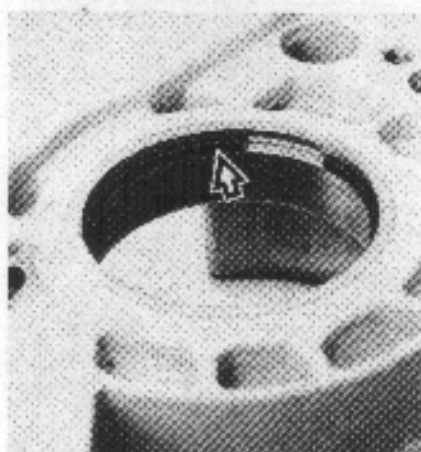

The crankshaft, connecting rod and needle bearing are an inseparable unit. This means that the crankshaft must always be replaced as a complete unit if any one of these parts is damaged. When installing a replacement crankshaft the ball bearings and oil seals should always be replaced as well. If the crankcase is damaged it must be replaced as a **complete unit** (ignition and clutch sides). All other parts which are still serviceable can then be transferred from the old to the new crankcase. However, this should first be done after installing the new bearings, i. e. the crankcase has to be heated for this purpose.

If the old crankcase is used again, remove the crankcase gasket and clean the sealing faces with a scraper.

The sealing faces must be absolutely clean to ensure a perfect seal. If a new crankcase is being

Installing ball bearing with  
press arbor 118 893 7200

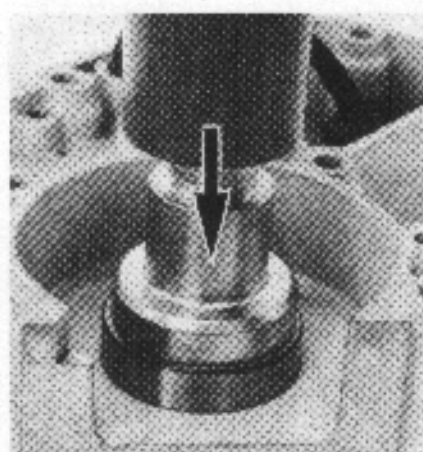

fitted, first insert a new snap ring in the groove of the bearing seat on the clutch side. Heat both halves of the crankcase to 150 to 180°C.

**Caution:** Before heating the crankcase, remove all plastic parts – fuel filler cap, oil filler cap, valve (oil tank vent), hose with pickup body in oil tank, impulse hose, elbow connector and fuel hose with pickup body, chain catcher bolt.

Fit the ball bearings squarely – without canting – from the inside of the crankcase so that the outer races butt against the crankcase shoulder or the snap ring. If the crankcase is heated as specified the ball bearings can be installed by hand. If there are no facilities for heating the crankcase, the bearings can be pressed home with a press arbor.



Installed cylindrical pins project slightly

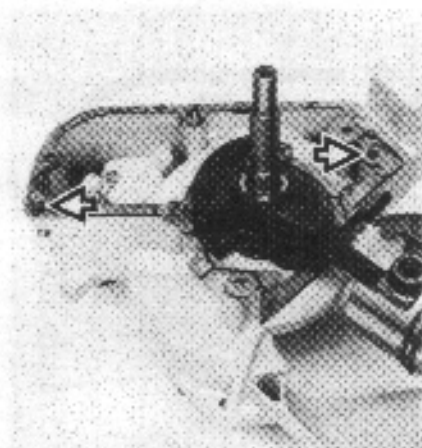

The inner races of the ball bearings must also be heated for insertion of the crankshaft. This is best done with a soldering iron and a suitable attachment.

Push the tapered stub of the crankshaft into the bearing on the ignition side of the crankcase until the crankshaft shoulder butts against the inner race.

Coat the mating faces of the two crankcase halves with jointing paste. Knock cylindrical pins into the ignition half of the crankcase so that they project slightly. Fit the gasket on the ignition half of the crankcase. Fit clutch half of crankcase over the straight stub of the crankshaft.

Align and assemble the two halves of the crankcase and drive the cylindrical pins fully home. Insert and tighten down the seven pan head screws to a torque load of 5 Nm in a diagonal pattern.

Tightening the 7 screws with a torque wrench

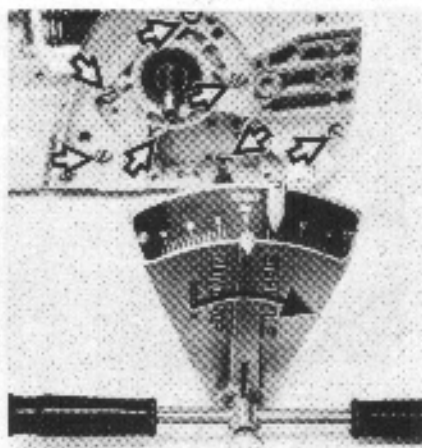

Cut away any excess gasket material at the cylinder mounting face. Place the chain adjusting screw with nut and clamping block in the housing slot.

Place the inner side plate on the crankcase; the curved faces must point towards the crankcase. Use special tool to fit the two collar studs and tighten them down firmly.

Refit the parts disassembled before crankcase was heated. Apply a little grease to the valve seat and press in the valve (oil tank vent).

Lubricate the oil seals with a little grease before assembly. Install both oil seals with assembly sleeve 1113 893 4600. The top face of the oil seal at the ignition side must be installed flush with the recessed housing shoulder. Fit the oil pump (8.7.4). Fit the contact breaker set or trigger plate and ignition armature (4.12.3; 4.9.6).

Top:  
Installing oil seal (clutch side)  
Bottom:  
Installing oil seal (ignition side)

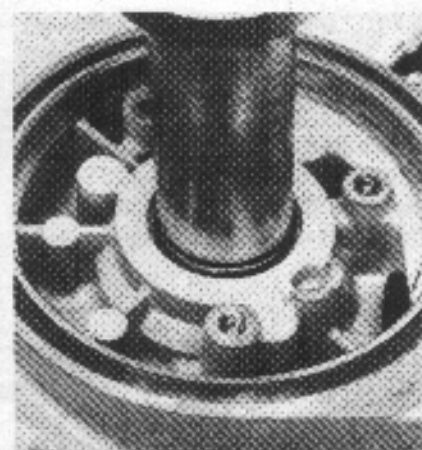
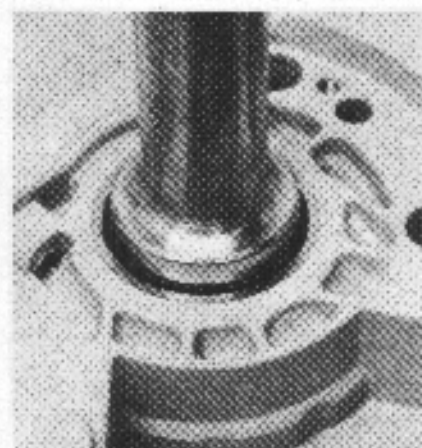

Assembly of the remaining parts is a reversal of the disassembly procedure.

### 3.7.4.1 Installation of Crankshaft (Heated Handles)

See chapter 3.7.4 plus assembly of generator (7.4.4).

### 3.7.2 Removal of Carburetor 031 (030)

### 3.8 Leakage Testing the Crankcase

Turn trigger plate clockwise

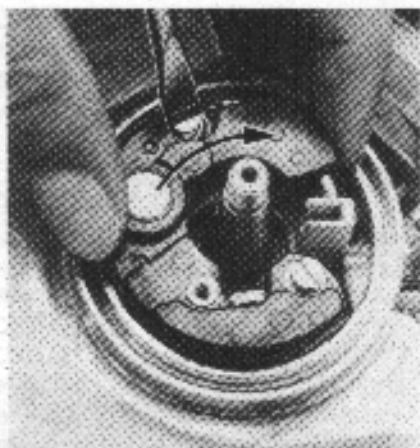

Top:  
Carburetor and crankcase tester  
11068502905  
Bottom:  
Vacuum pump for crankcase  
00008503500

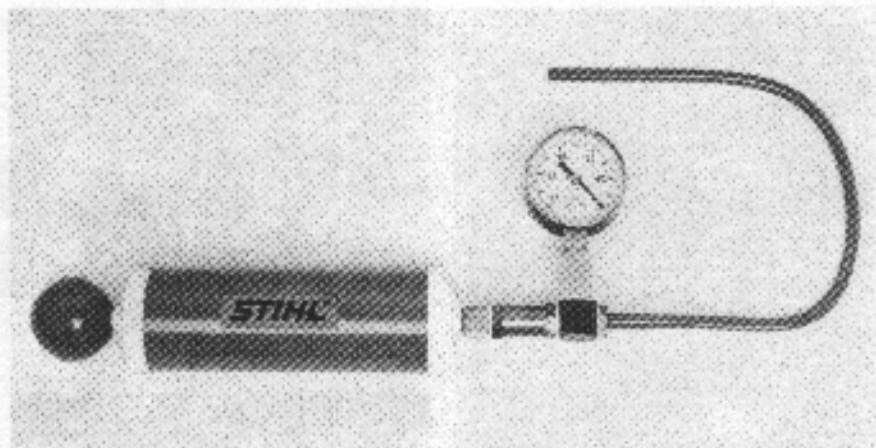

### 3.7.5 Installation of Crankshaft 031 (030)

See chapter 3.7.4.

**Note:** Before tightening down the mounting screws turn the trigger plate clockwise to ensure that it does not run against the flywheel.

#### 3.7.5.1 Installation of Crankshaft on 031 (030) with Heated Handles

See chapter 3.7.4, plus the following:

When fitting the handle frame, grip the impulse hose with a pair of pliers and push it onto the elbow connector on the crankcase. Before securing the handle frame tighten down the clamp at the transition between valve and muffler after pushing the valve into position.

Defective oil seals and gaskets or cracks in castings are the usual causes of leaks. Such faults allow supplementary air to enter the engine and thus upset the fuel-air mixture.

This makes adjustment of the prescribed idle speed difficult or even impossible. Moreover, the transition from idle speed to part or full throttle is not smooth.

The crankcase can be checked accurately for leaks with the carbu-

retor/crankcase tester and the vacuum pump.

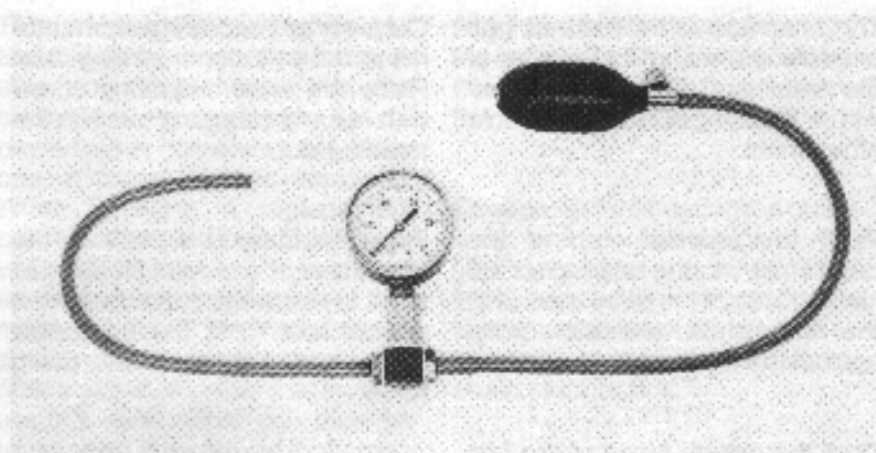



## 3.8.1 Pressure Test

Top:  
Test flange 11138504200  
Sealing plate 00008508100  
Bottom:  
Test flange in position

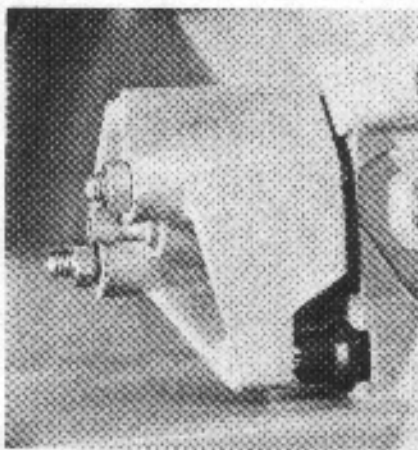
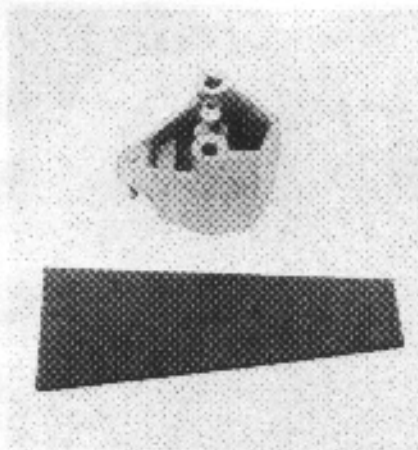

Remove carburetor. Fit the test flange over the studs and tighten it down moderately with the two M 5 nuts. One of the two pins in the test flange must seal the impulse hose. Unscrew the pan head screw which secures the muffler cover and take off the cover.

Unscrew the casting at the cylinder exhaust port and crankcase. The screws at the cylinder exhaust port can be released with a socket wrench applied through the two

Top:  
Unscrew muffler casing  
Bottom:  
Leakage test

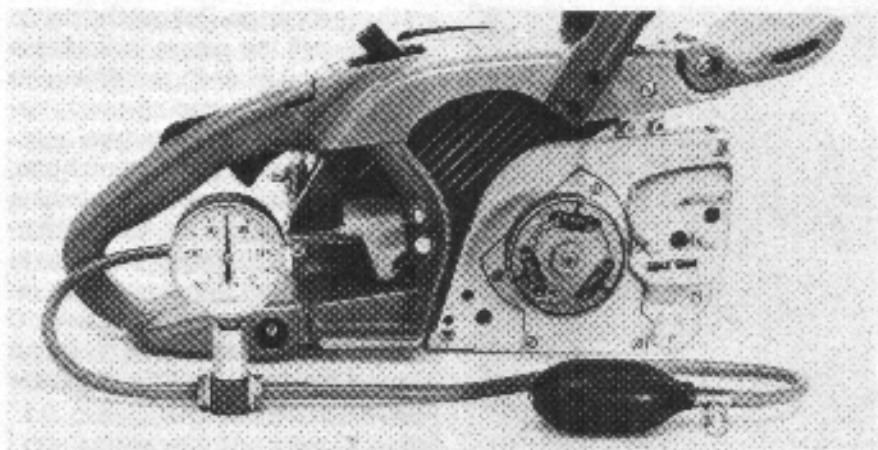
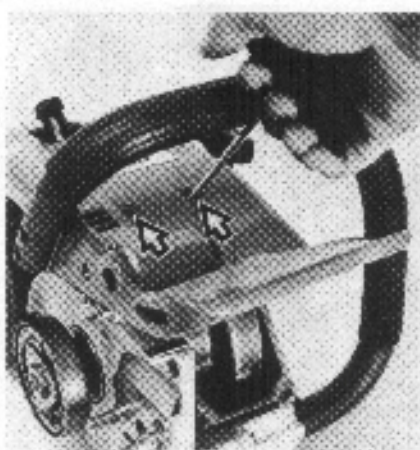

holes in the handle frame. Place the sealing plate over the cylinder exhaust port. Refit the casing with the two screws on the cylinder exhaust port. Do not overtighten the screws. Make sure the spark plug is securely tightened down and set the piston to top dead center (T.D.C.).

Connect tester's pressure hose to the nipple of the test flange. Close the bleed screw on the rubber bulb and pump air into the crankcase

Sealing plate on cylinder exhaust port

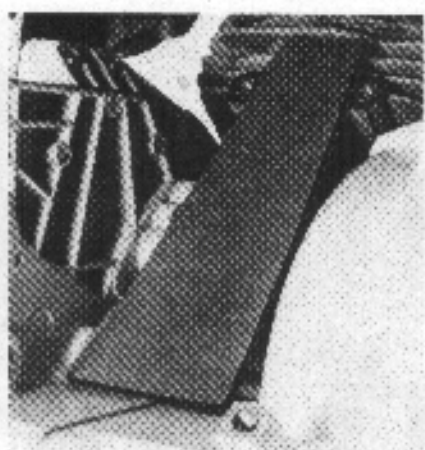

until the pressure gauge shows a pressure of 0.5 bar (7 psi). If this pressure remains constant, the crankcase is airtight. However, if the pressure reading drops the leak must be found and the faulty part replaced.

After completing the test open the bleed screw and disconnect the pressure hose.



## 3.8.2 Vacuum Test

Top:  
Vacuum Test  
Bottom:  
Suction hose connected

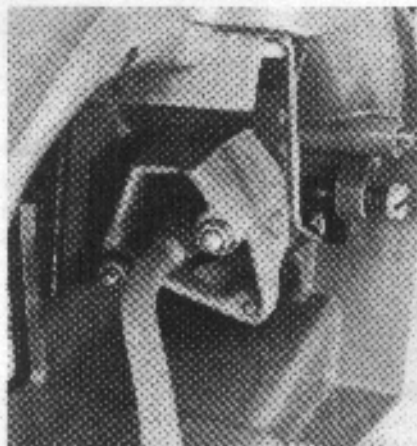
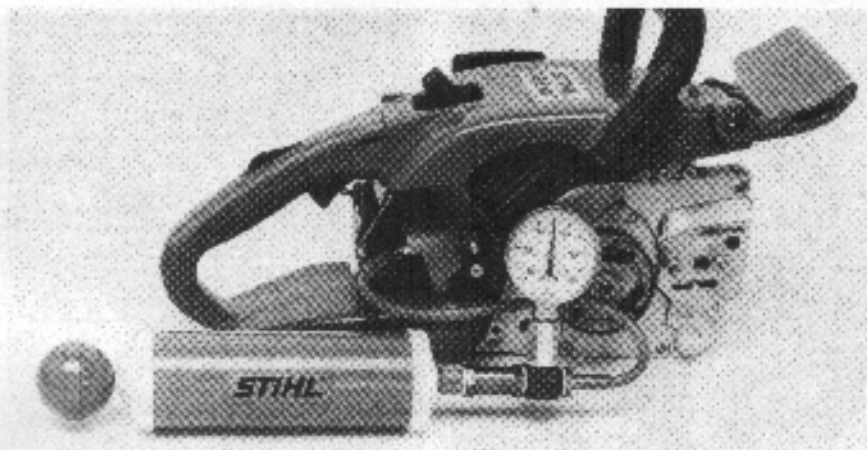

of the test flange. Pull out the pump piston until the gauge indicates a vacuum of 0.5 bar (7 psi). When the handle of the pump piston is released the non-return valve automatically closes the suction hose. If the vacuum reading remains constant or drops no further than 0.3 bar (4.5 psi), the oil seals are in good condition. However, if the vacuum continues to drop (down to 0 bar), the oil seals must be replaced – even if no leaks were found in the previous pressure test.

Oil seals tend to fail when subjected to a vacuum. During the piston's induction stroke the sealing lip lifts off the crankshaft owing to the lack of internal counterpressure.

An additional test can be carried out with the vacuum pump to detect this fault. The preparations for this test are the same as for the pressure test (3.8.16).

Connect suction hose to the nipple

## 3.8.3 Leaking Testing the Crankcase 031 (030)

Top:  
Unscrew carburetor box  
Bottom:  
Removing mounting screws

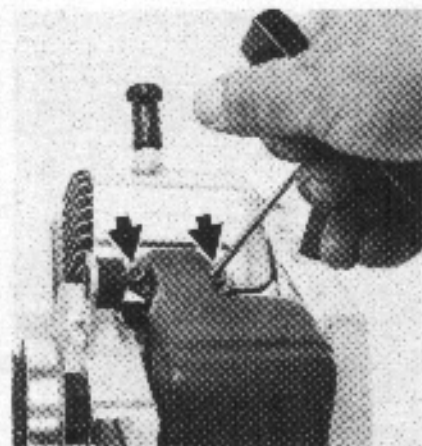
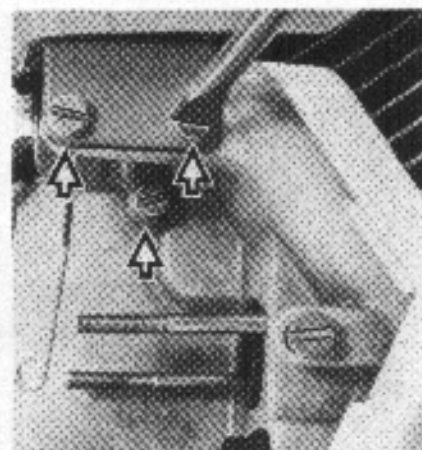

Remove carburetor (3.5). Take off the handle frame. The carburetor box must remain on the saw; it is secured to the handle frame by means of three pan head screws.

Remove the muffer mounting screws at the cylinder exhaust port, take off the air guide plate and fit the sealing plate in its place.



## 3.8.4 Replacing the Oil Seals

Top:  
Sealing plate in position  
Bottom:  
Test set up

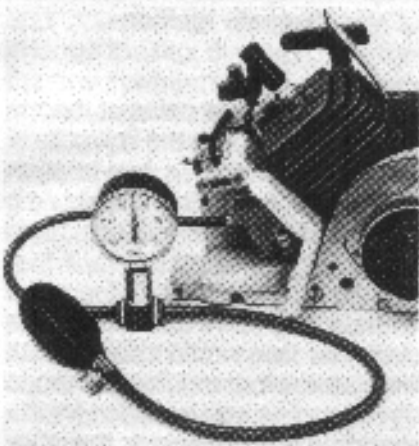
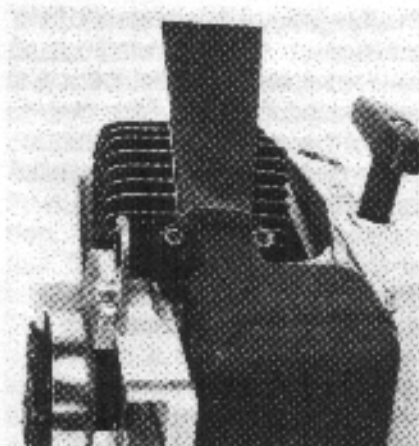

Refit screws at cylinder exhaust port but do not overtighten them.

Slip test flange over the studs on the carburetor box and tighten it down moderately with the two M 5 nuts. One of the two pins in the test flange must seal the impulse hose.

The test procedure is then as described in chapters 3.8.1 and 3.8.2.

Oil seal puller  
00008904400

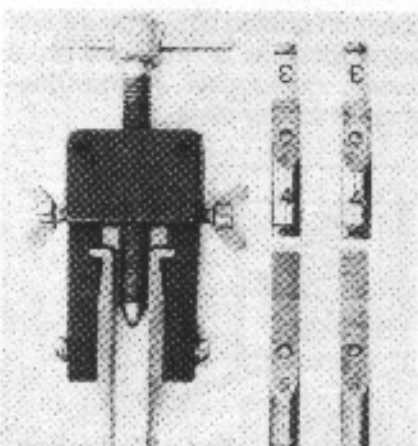

If the oil seals have to be replaced it is not necessary to disassemble the engine. Only the clutch, flywheel and trigger plate or contact set need to be removed.

The procedures are described in the corresponding chapters for the 032/031 and 030.

The oil seal at the Ignition side can be pulled out of its seat in the crankcase with the special puller fitted with No. 3 jaws.

The oil seal at the clutch side is prised out with a screwdriver. Care must be taken in both cases. Make sure the sealing face on the crankshaft is not damaged at the ignition side and the cage of the ball bearing at the clutch side.

See 3.7.4 for installation of the new oil seals.

Top:  
Extracting oil seal at  
ignition side  
Bottom:  
Levering out oil seal  
at clutch side

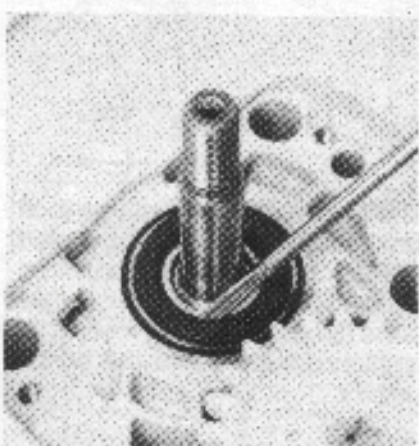
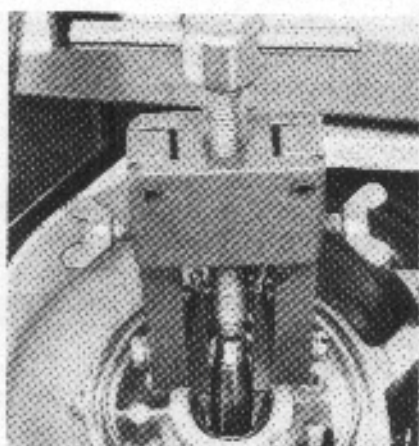

## 4. Ignition System

Like all STIHL gasoline chain saws the 032 and 031 (030) are equipped with a magneto ignition system that requires neither a battery nor a dynamo. Different ignition systems are used on the various models, i.e. a breaker-controlled magneto ignition system is installed on some models and a breakerless (electronic) magneto ignition system on others.

### 4.1. Construction

The Bosch ignition systems (both breaker and transistor-controlled) are of a component-type construction and consist of three main parts – the flywheel (magnet wheel), the ignition armature and the control unit.

The flywheel carries the permanent magnet with a north and south pole and is located on the crankshaft stub. The ignition armature (Bosch) is mounted in the crankcase on the periphery of the flywheel so that it can only be adjusted in the radial direction.

The control elements of the ignition systems, i.e. the contact set with condenser or the trigger plate, are installed in the crankcase behind the flywheel. All electronic control components are incorporated on a

common printed circuit board and embedded in a moisture-proof plastic compound in the ring-shaped trigger plate

### 4.2 Description of Operation

#### 4.2.1 General

A magneto ignition system operates on the basis of magnetic induction. On both the breaker and transistor-controlled ignition systems this involves only "dynamic induction".

In **dynamic induction** the electric current is generated in a conductor by moving the conductor through the flux lines of a magnetic field. The magnitude of the induced voltage is, among other things, dependent on the strength of the magnetic field and the speed of the flux change. This in turn is influenced mainly by the intensity of the movement.

In terms of the magneto ignition system this means: As the flywheel rotates the flux lines flowing between the poles of the permanent magnet, from north pole to south pole, create a magnetic flux in the iron core of the coils.

The flux lines of this magnetic field cut through the wire windings of the respective coil and induce a low-tension current. The magnitude of the voltage is, therefore, basically dependent on the rotational speed of the flywheel

#### 4.2.2 Breaker-Controlled Magneto Ignition

When the magnet poles of the rotating flywheel pass the iron core of the armature coils a low-tension voltage is induced in the coils as a result of the magnetic flux.

Without any form of control the magnetic flux would rise and fall like a sine-wave and finally change direction. The same applies for the electric voltage. However, the magnitude of a voltage pulse generated in this way would not be sufficient to produce a sparkover.



Diagram of ignition system

- |  |                   |
|--|-------------------|
| 1 Flywheel   | 4 Contact breaker |
| 2 Permanent magnet with north and south pole shoes | 5 Condenser       |
| 3 Armature with primary and secondary windings     | 6 Spark plug      |
|  | 7 Stop switch     |
|  | 8 Edge gap        |
|  | 9 Air gap         |

This means that the voltage curve must be controlled. In this system the mechanical contact breaker performs the control function. The contact breaker is opened by the cam lobe ground on the hub of the flywheel and closed by spring action. At the moment of maximum flux the contact breaker closes and thus closes the primary circuit. The induced voltage thus causes a current to flow in the primary winding which builds up a magnetic field (armature field) around the coil. This is opposed to the induced magnetic field (exciter field) and counteracts its tendency to change the flux direction. The further the flywheel rotates, the greater the tendency of the exciter field to change the flux direction. The opposing armature field and thus the primary current must also increase accordingly. When the current finally reaches its peak value the contact breaker opens - this instant is called "magnet breakdown". This causes the magnetic field in the armature core to suddenly change direction and induce a high-tension pulse in the secondary winding of the armature which is proportional to the high number of turns in the winding.

This pulse is fed via the high-tension ignition lead to the spark plug and is discharged as a sparkover from the center to the ground electrodes and thus ignites the fuel-air mixture.

A condenser is wired in parallel with the contact breaker in the

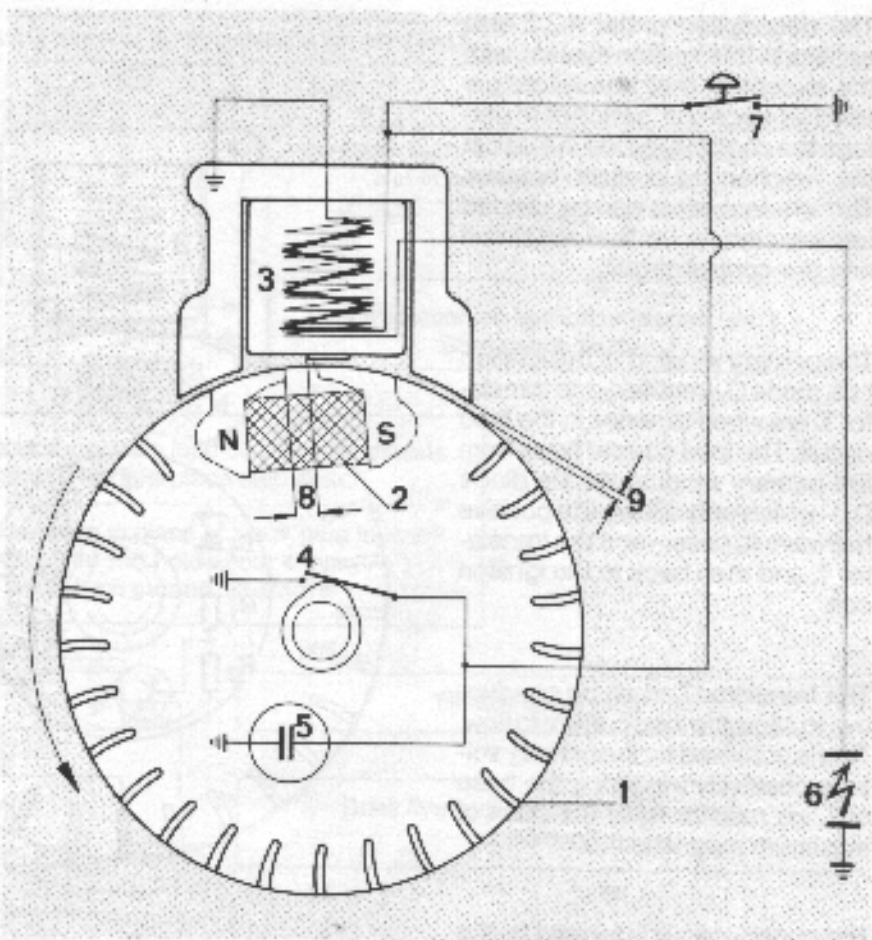

primary circuit in order to prevent excessive sparking (arcing) between the breaker points while they are opening and ensure that there is no loss of energy or premature erosion of the points.

The primary circuit is permanently closed by means of the stop switch. This suppresses the abrupt change in direction of the magnetic flux so that no further high-tension pulse can be induced.

### 4.2.3 Bosch Transistor-Controlled Magneto Ignition

The description under 4.2.2 also applies to this ignition system, with the exception that transistors are used as electronic switches in place of the mechanical contact breaker. The whole system can be divided into two circuits, i.e. the load circuit and the control circuit.

The primary winding of the ignition coil, diode  $D_2$  (rectifier) and transistor  $T_1$  are wired in series in the load circuit. The load current flows from the primary winding via the diode  $D_2$  – which only allows the positive halfwave to pass – and the transistor  $T_1$ , and then back to the ignition coil.

The transistor  $T_1$  must be conductive to allow the load current to flow. This is achieved by the primary voltage positively triggering the base of  $T_1$  via resistor  $R_3$  at the point of maximum magnetic flux.

The control circuit is formed by the primary winding of the ignition coil, zener diode  $D_1$ , the resistors  $R_1$  and  $R_2$  (voltage dividers) and the transistor  $T_2$ . Voltage rises as the load current increases. The voltage rises to the breakdown value of the zener diode  $D_1$  just before the load current reaches its peak value.  $D_1$  becomes conductive – the control circuit is closed, the base of  $T_2$  is positively triggered,  $T_2$  becomes conductive. The control current for  $T_1$  now flows via  $T_2$ , thus causing the potential at the base of  $T_1$  to return to the negative state,  $T_1$  inhibits current flow and the load circuit is

Diagram of ignition system

- |  |                 |
|--|-----------------|
| 1 Flywheel   | 4 Trigger plate |
| 2 Permanent magnet with north and south pole shoes | 5 Spark plug    |
| 3 Armature with primary and secondary windings     | 6 Stop switch   |
|  | 7 Air gap       |

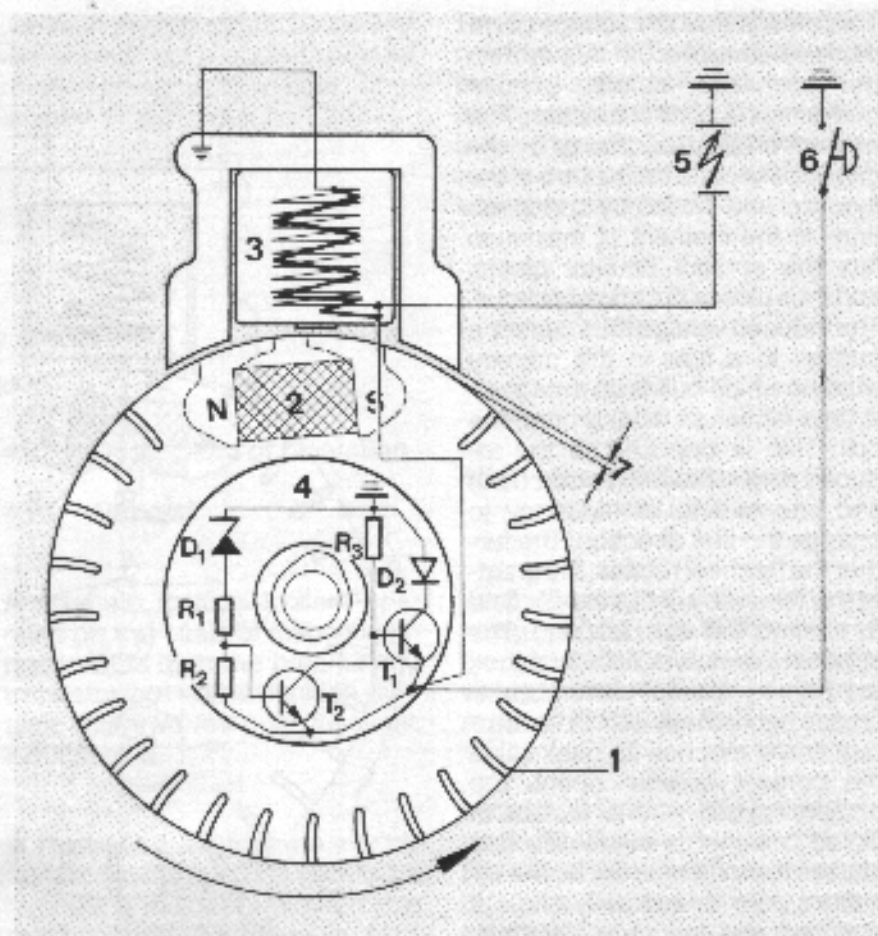

open. This corresponds to the opening of the contact breaker.

The process up to sparkover then takes place as described under 4.2.2.





## 4.3.2 Electronic Ignition

Extreme caution must be exercised during fault finding, maintenance and repair work in the ignition system. Serious accidents can result from the high voltages which occur!

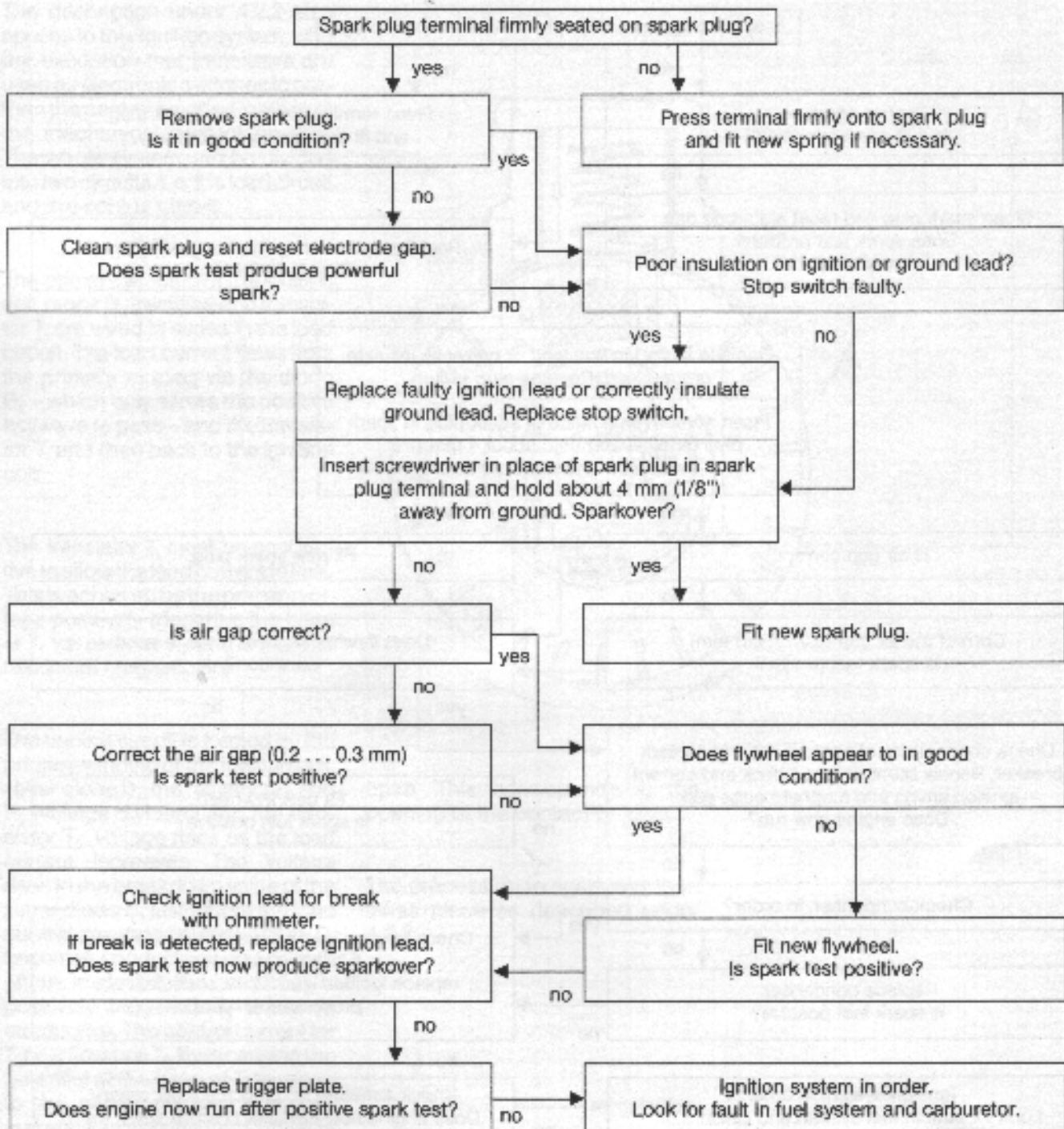



## 4.4 Spark Plug

## 4.4.3 Checking and Cleaning Spark plug

## 4.4.1 Description of Operation

The high-tension pulse generated in the ignition armature is fed to the spark plug and discharged as a sparkover between the center and ground electrodes. When the spark plug is in good condition and the electrode gap is correct, this spark ignites the fuel-air mixture.

Troubleshooting on the ignition system should always begin at the spark plug. In the event of starting difficulties, low engine power or misfiring, unscrew the spark plug and check whether it is a STIHL approved one. The Champion RCJ 6 Y suppressed spark plug is an approved alternative to the standard Bosch WSR 6 F (formerly WKA 200 TR 6). These spark plugs cover a

wide thermal range and offer good performance under arduous operating conditions.

Never use a steel wire brush for cleaning a sooted or carbonized spark plug. Always use a brass wire brush for this purpose and then blow out the plug with compressed air.

## 4.4.2 Troubleshooting Chart

The appearance of the spark plug's insulator nose gives important information with regard to the effects of various operating conditions:

Condition of insulator	Appearance	Some associated operating conditions
<b>Normal:</b>	greyish yellow to brown, dry	Enging in order, spark plug heat range is correct
<b>Sooted:</b>	velvet-like, dull black coating of soot	Mixture too rich, lack of air (dirty air filter, choke valve partly closed), electrode gap too wide, heat range too high
<b>Smearred with oil:</b>	Coating of damp oil carbon and soot	Too much oil in fuel mix
<b>Overheated:</b>	Welding beads on insulator nose, eroded electrodes	Mixture too lean, spark plug loose, heat range too low

Top:  
Spark plug brush 1105 894 4200  
Bottom:  
Checking electrode gap

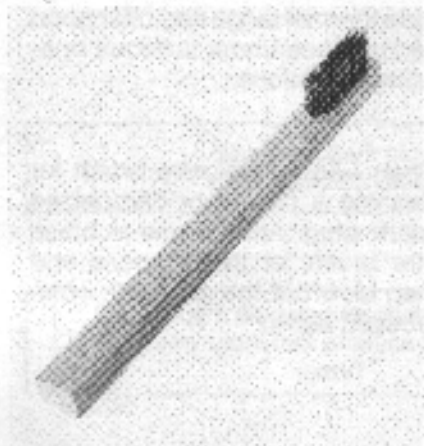

Resetting electrode gap  
with spark plug gauge



Unscrew nut from stop switch

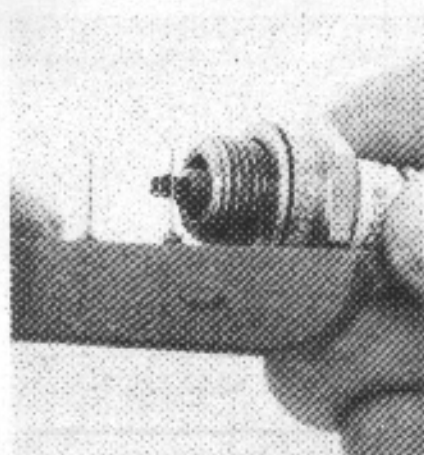
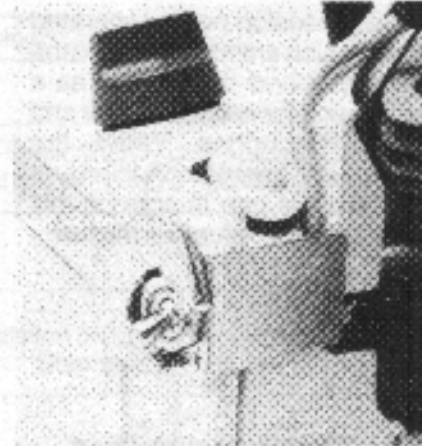

Accurate checking of the spark plug is only possible with a special spark plug tester. A provisional check can be carried out by fitting the clean spark plug in the ignition lead terminal and holding it against ground. There should be a healthy sparkover at the electrodes when the starter rope is pulled.

ground can occur and thus interrupt the ignition process. The ignition lead must be renewed in such a case.

#### 4.5.2 Removal of Ignition Lead on 032 Heated Handles

Remove handle frame (3.3., 3.3.1). Unscrew hexagon nut from stop switch. Take off plate and cover plate. Pull rubber boot off ignition armature connection. Unscrew ignition lead from wood screw on high-tension output of armature. Use a suitable pair of pliers to grip and pull leg spring with ignition lead forwards out of the lead terminal. Disconnect leg spring from ignition lead.

If the spark plug is smeared with oil, wash the insulator nose in a grease solvent and blow out with compressed air.

As the electrode gap becomes wider through normal erosion the gap must be checked with a spark plug gauge at regular intervals and reset as necessary. The specified gap is **0.5 mm** and can be restored by bending the ground electrode. However, a new spark plug should always be fitted if the electrodes are badly eroded.

#### 4.4.4 Installation of Spark Plug

Before refitting the spark plug in the cylinder, clean the plug's seat and make sure the sealing ring is in good condition. Screw in spark plug a few turns by hand and then tighten it down to a torque load of 25 Nm.

### 4.5. Ignition Lead

#### 4.5.1 Description of Operation

The ignition lead feeds the high-tension pulse generated in the ignition armature to the spark plug. If its insulation is brittle or damaged in any other way a sparkover to



Top:  
Cover plate removed  
from stop switch  
Bottom:  
Remove rubber boot

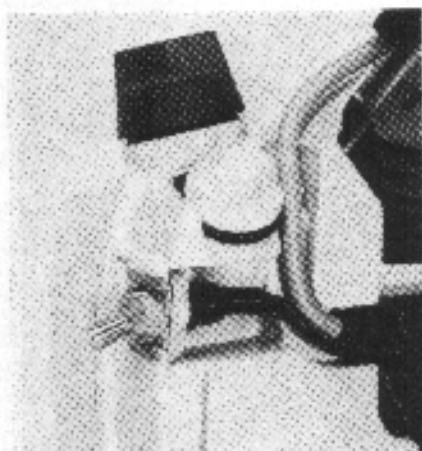

Top:  
Unscrew ignition lead  
Bottom:  
Pull out leg spring

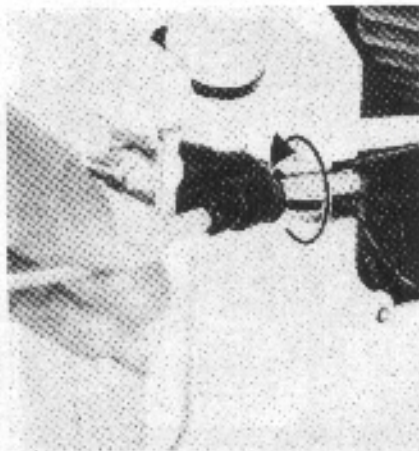

Pinch hook into ignition  
lead

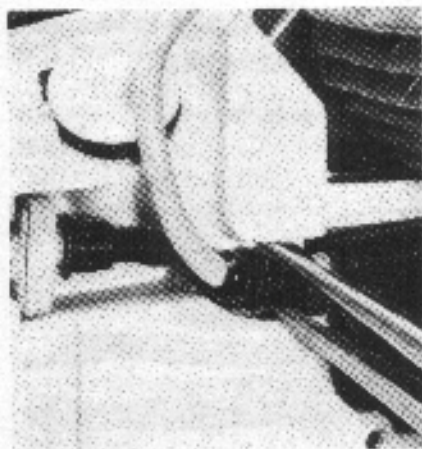
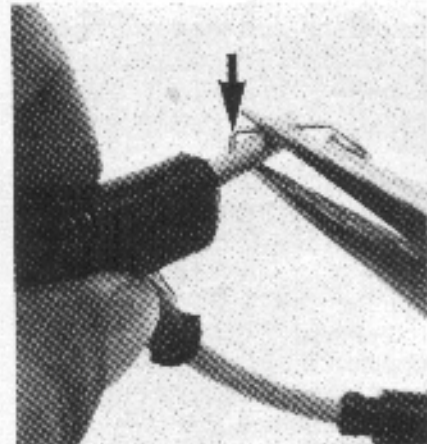

into the center of the lead cross section. Pull lead back so that the leg spring locates in the terminal. Push the rubber boot over the other end of the lead and screw the lead firmly onto the wood screw in the armature - this is made easier if a hole is made in the center of the lead with a pointed tool. Assembly is then a reversal of the disassemble sequence.

#### 4.5.3 Removal of Ignition Lead 031 (030)

Remove handle frame (3.5, 3.5.1)  
See chapter 4.5.2.

#### 4.5.4 Visual Inspection

Examine ignition lead for signs of damage to insulation; check continuity with ohmmeter if necessary. The rubber boot must be in perfect condition to ensure protection

against moisture. If this is not the case, fit a new rubber boot.

#### 4.5.5 Installation of Ignition Lead on 032 with Heated Handles

The new ignition lead has a length of 150 mm. Coat one end of the lead with a little oil and push it into the terminal. Use a suitable pair of pliers to grip and pull the end of the lead out through the terminal. Pinch the hook of the leg spring

#### 4.5.6 Installation of Ignition Lead - 031 (030)

The new ignition lead has a length of 115 mm. Installation is other as described in 4.5.5, but protective tube must be fitted over the ignition lead.

## 4.6 Ground Lead

## 4.6.1 Description of Operation

The ground lead short circuits the primary circuit to ground when the contacts of the Stop Switch are closed in order to stop the engine.

## 4.6.2 Checking the Ground Lead

Examine the insulation of the ground lead. It must be in perfect condition. If it is damaged, a short circuit to ground may occur at the point of damage and thus cause the ignition to operate erratically or even fail completely. As the ground lead cannot be replaced as a separate item, the defective insulation must be repaired in such a case.

## 4.6.3 Exposing the Ground Lead

Remove handle frame (3.3), fan housing, flywheel (4.8.2) and trigger plate (4.12.3). (Contact set need not be removed.)

## 4.6.4 Exposing the Ground Lead - 031 (030)

Remove handle frame (3.5), fan housing (3.5), flywheel (4.8.4) and trigger plate. (Contact set need not be removed.)

The primary circuit is shorted to ground when the stop switch is in the "STOP" position. This terminates the ignition process and shuts down the engine.

## 4.7 Stop Switch

## 4.7.1 Description of Operation

Stop switch and ground lead

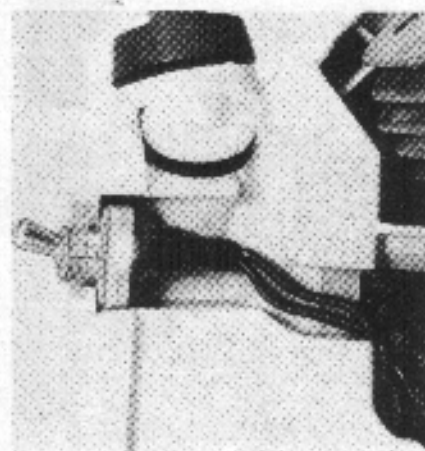

## 4.7.2 Checking the Stop Switch

Pull ground lead off the stop switch. Set ohmmeter to measure range " $\Omega \times 1$ ". Flick stop switch to "STOP". Hold one of the two test leads against the metallic housing and the other against the lead connector. The ohmmeter pointer must move to "0". When the switch is off, i.e. away from STOP, the pointer must be on " $\infty$ ". If these results are not obtained, the stop switch is faulty and must be replaced.

## 4.7.3 Removal of Stop Switch

Remove handle frame (3.3). Unscrew hexagon nut and push stop switch with cover plate and plate out of the side of the housing cut-out. Pull off the ground lead.

Top:  
Pull ground lead off the stop switch  
Bottom:  
Checking in "STOP" position

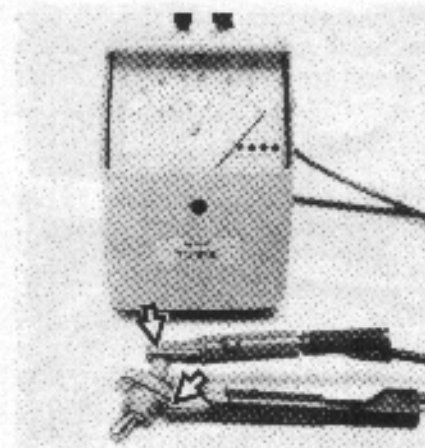
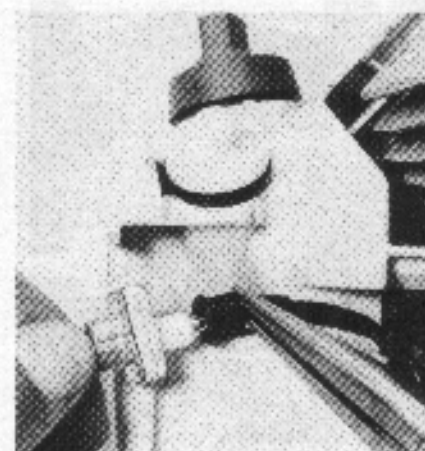

## 4.7.4 Installation of Stop Switch

Installation is a reversal of the disassembly procedure. Ensure that the slot in the stop switch body faces vertically upwards.



## 4.8. Flywheel

### 4.8.1 Description of Operation

Slot must face upwards



#### Removal of Stop Switch on 031 (030)

Remove handle frame and carburetor box (3.5). Unscrew the hexagon nut and push stop switch with plate out of the side of the housing cutout. Pull off the ground lead.

#### Installation of Stop Switch on 031 (030)

Installation is a reversal of the disassembly procedure. Ensure that the slot in the stop switch body faces vertically upwards.

The flywheel has several functions. It accommodates the permanent magnet with a north and south pole for the ignition system (polarized in the engine's normal direction of rotation). The relatively large flywheel mass ensures that the engine turns smoothly, i.e. it substantially suppresses the normal irregularities of the engine's combustion process.

Remove fan housing

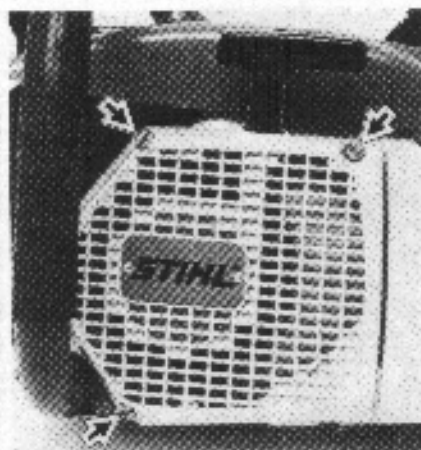

Releasing hexagon nut

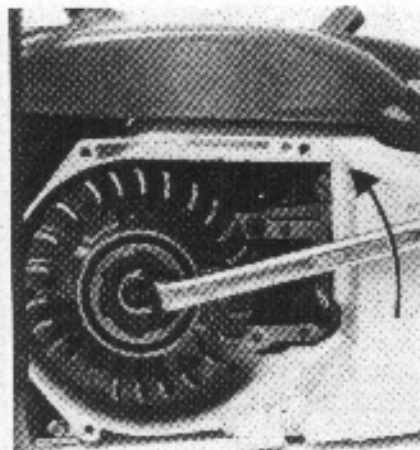

The front of the flywheel is designed as a fanwheel to provide the necessary air for engine cooling. Six pawl notches are machined in the hub on the front side of the flywheel and transmit the starting torque to crankshaft.

#### 4.8.2 Removal of Flywheel

The flywheel is mounted at the ignition end of the crankshaft on a taper seat, located by means of a key and secured with a hexagon nut.

To disassemble the flywheel, first remove the fan housing, unscrew the spark plug and fit the locking screw in its place and tighten down by hand. Turn the flywheel counterclockwise until the piston head butts against the locking screw. Use socket wrench to release and unscrew the hexagon nut counterclockwise. Screw flywheel puller into the thread of the flywheel hub as far as it will go.

Top:  
Puller 1110 890 4500  
Bottom:  
Pulling off flywheel



Key in position

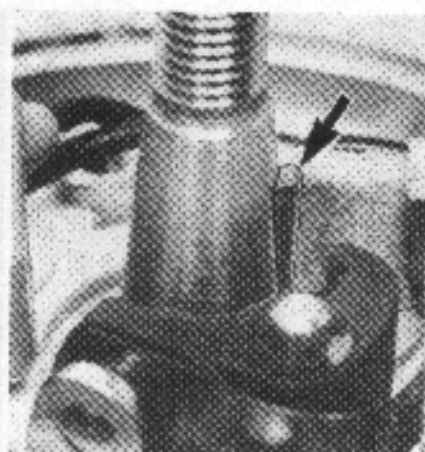

Top:  
Key slot in flywheel hub  
Bottom:  
Tighten the crankshaft nut

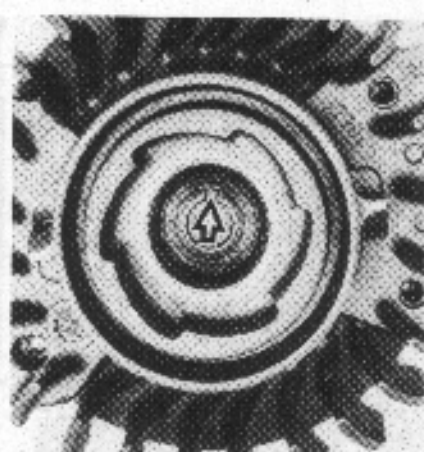

#### 4.8.3 Removal of Flywheel

Clean the crankshaft taper and flywheel hub bore with a suitable degreasing agent (e. g. trichlorethylene, diluted nitro). Make sure the key is properly positioned in its slot. Fit the flywheel on the crankshaft so that the key engages in the slot in the flywheel hub. Screw hexagon nut onto the crankshaft stub and tighten it down to a torque load of 30 Nm.



Hold the threaded sleeve of the puller with a 24 mm open-end or ring wrench and tighten down the thrust bolt with a 19 mm wrench until the flywheel hub is released from the crankshaft taper. The flywheel will come off its seat more easily if the puller's thrust bolt is tapped with a hammer after it has been tightened down.

The key is only provided to ensure that the flywheel is correctly positioned. The driving force between the crankshaft and flywheel must be absorbed entirely by the taper seat. It is therefore absolutely essential to ensure that the crankshaft nut is tightened down to the specified torque of 30 Nm.

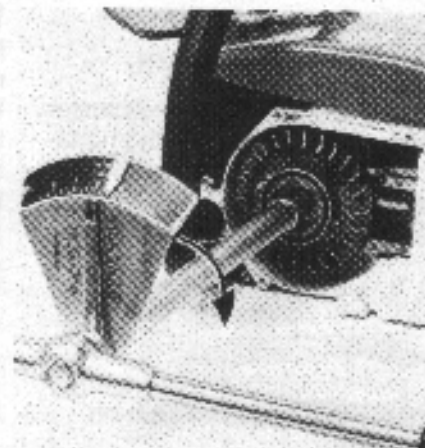

Finish off by removing the locking screw, refitting the spark plug and fan housing.

#### 4.8.4 Removal of Flywheel 031 (030)

Remove handlebar and fan housing with tank housing (3.5). Disassembly is otherwise as described in 4.8.2.

#### 4.8.5 Installation of Flywheel 031 (030)

See 4.8.3



## 4.9 Ignition Armature

### 4.9.1 Construction

#### Ignition armature

- 1 Primary connection
- 2 Secondary connection
- 3 Ground connection

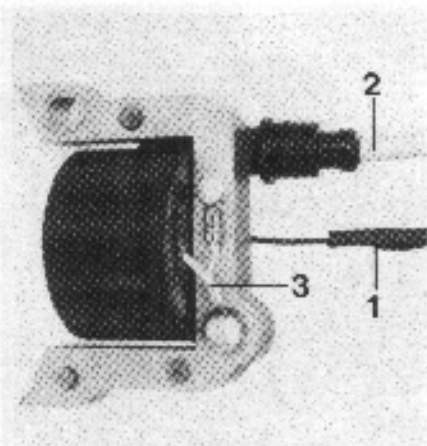

On the ignition armature the primary and secondary coils are arranged on the center arm of the iron core and encased in a plastic compound to make them moisture-proof. Three electrical connections emerge from the coil body, i.e. the primary and secondary connections and the common ground connection which is riveted to the core.

#### 4.9.2 Resistance Test on Primary Winding

There are two ways of testing the ignition armature:

1. The resistance of both coil windings can be checked with the aid of an ohmmeter.
2. An ignition coil tester must be used for accurate testing.

To test the primary winding, remove the handle frame and fly-

Top:  
Stop switch away from "STOP"  
Bottom:  
Resistance test on primary winding

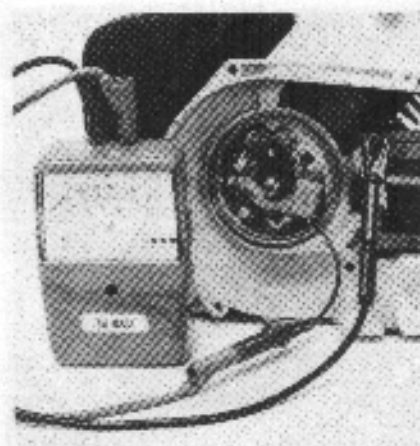

wheel (3.3 and 4.8.2) and disconnect lead from the contact set or trigger plate. Flick stop switch away from "STOP". Clip one of the two test leads to the primary lead and the other to ground of ignition armature.

In measuring range " $\Omega \times 1$ " the ohmmeter should show a value between 0.7 and 1.0  $\Omega$ . If this value is not obtained, replace the ignition armature.

Resistance test on secondary winding

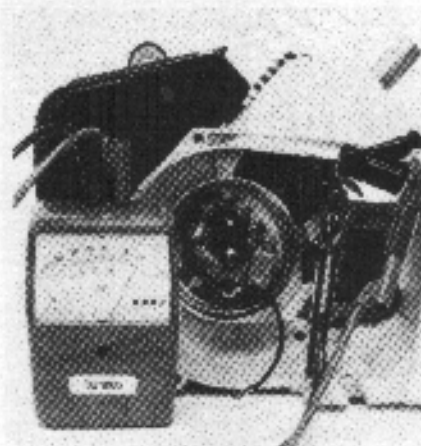

#### 4.9.3 Resistance Test on Secondary Winding

Connect one of the two test leads to the leg spring in the spark plug terminal and the other test lead to ground of ignition armature. In measuring range " $\Omega \times 1000$ " ( $k\Omega$ ) the ohmmeter should indicate a value between 7.7 and 10.3  $k\Omega$ .

If the reading obtained deviates from this value, carry out a second measurement. To do this, unscrew the ignition lead from the armature and connect the test lead directly to the secondary output of the armature. If the reading is still not within the defined limits, the ignition armature must be replaced.

Armature test with ignition coil tester

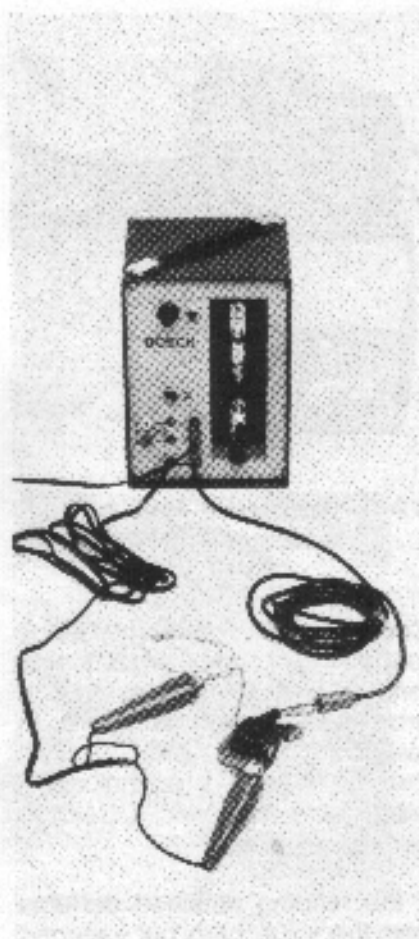

#### 4.9.4 Testing with Ignition Coil Tester

The sparkover can be checked with an ignition coil tester, e. g. Bosch EFMZ 1 A or EFAW 106 A. The armature must be removed from the machine and the ignition lead unscrewed for this purpose. In this test the spark length must be 7 mm at 2.4 A.

Top:  
Unscrew armature  
Bottom:  
Disconnect primary lead from trigger plate

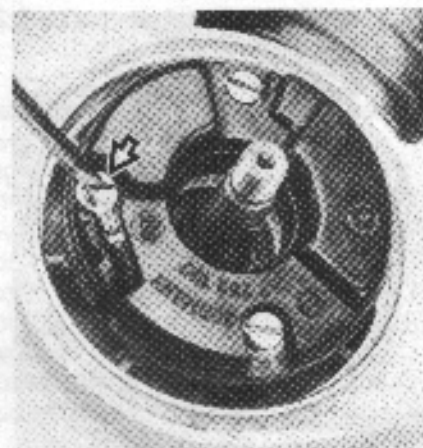
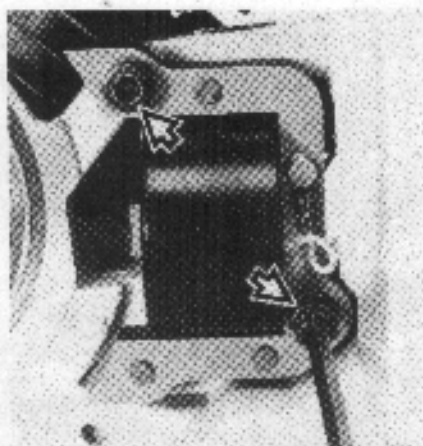

#### 4.9.5 Removal of Ignition Armature

Remove the handle frame and flywheel (3.3 and 4.8.2). Take the hexagon nut off the stop switch, lift off the plate and cover plate and pull off the ground lead.

Unscrew the ignition armature (two socket head screws). Disconnect the primary lead from the trigger plate or the contact set. Remove

Top:  
Disconnect primary lead from contact set  
Bottom:  
Remove trigger plate

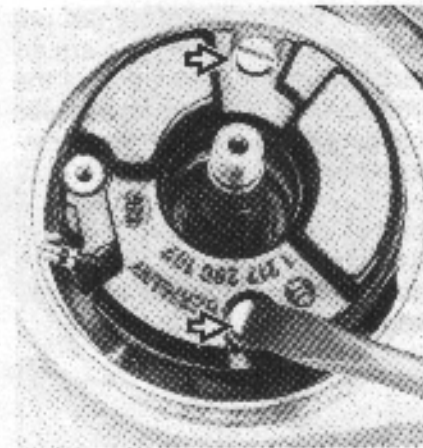
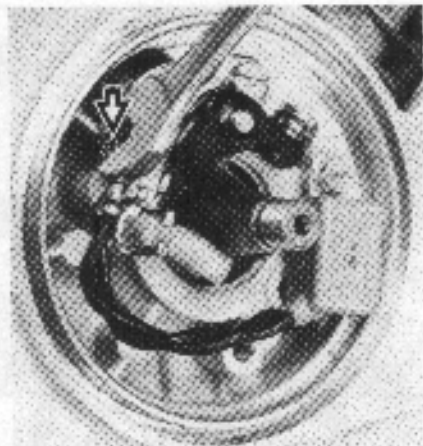

the trigger plate (two pan head screws). The contact set need not be removed. Remove ground lead from slot in trigger plate. Take off the ignition armature with primary/ground lead, stop switch and ignition lead. Take spark plug terminal off the defective ignition armature and transfer it to the new armature.



Top:  
Push primary lead through  
weatherproof grommet  
Bottom:  
Align flywheel

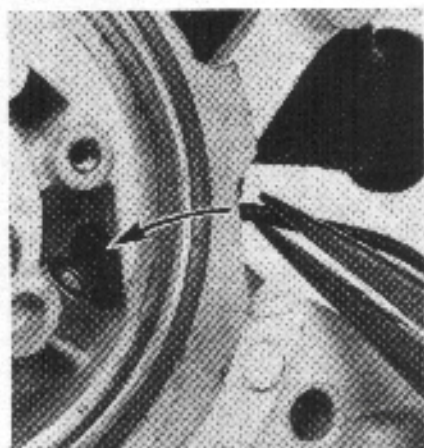

Top:  
Setting gauge 1111 890 6400  
Bottom:  
Setting gauge in position

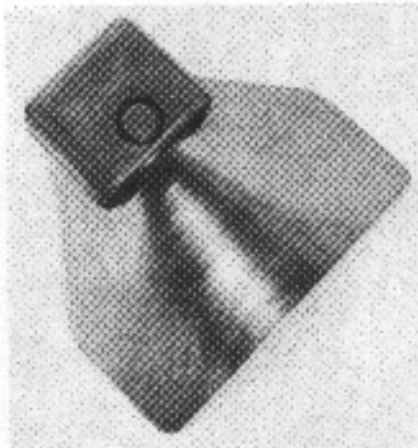

Top:  
Tighten ignition armature  
Bottom:  
Stop switch cover plate must  
hold ignition lead

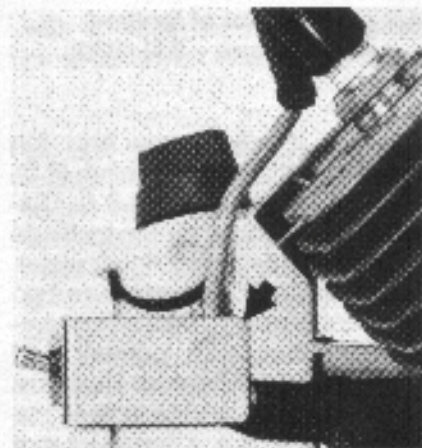
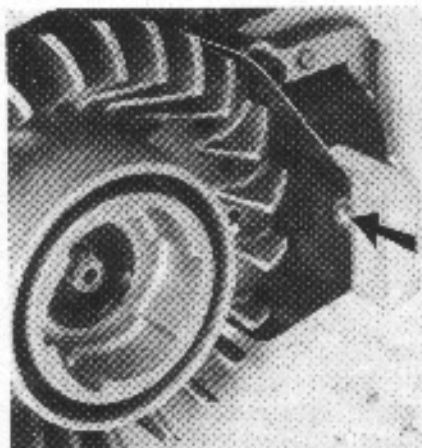
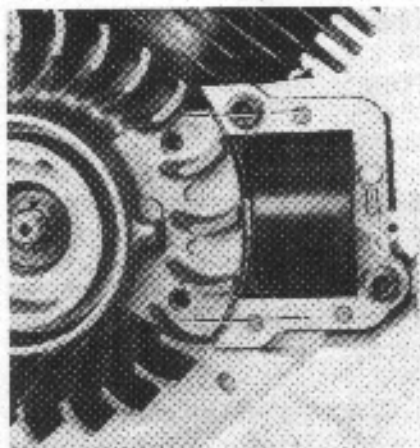
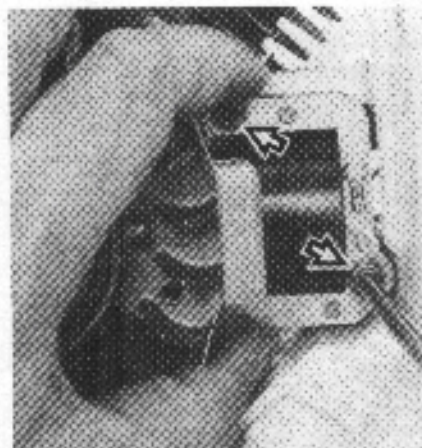

#### 4.9.6 Installation of Ignition Armature

Use a pair of pointed nose pliers to push the primary lead through the weatherproof grommet in the crankcase. Secure the ignition armature to the crankcase with the socket head screws – only provisionally at this stage.

Screw primary lead to contact set or trigger plate. Secure trigger

plate on crankcase, taking care not to pinch the primary lead! Fit the flywheel (4.8.3) and align it so that the area in which the magnets are embedded covers half of each of the two outer armature arms. Place the setting gauge or 0.2 mm gauge sheet between the magneto poles and the armature arms, press the armature firmly against the flywheel and tighten down the socket head screws. Pull out the gauge sheet and check the air gap with a feeler gauge. It should be between 0.2 and 0.3 mm. Attach ground

lead to stop switch and slip the switch in the housing slot. Fit the plate and cover plate and tighten down the stop switch with the hexagon nut. The ignition lead must be held in the housing recess by the cover plate. Install the fan housing and handle frame by reversing the disassembly procedure.



Remove ignition armature

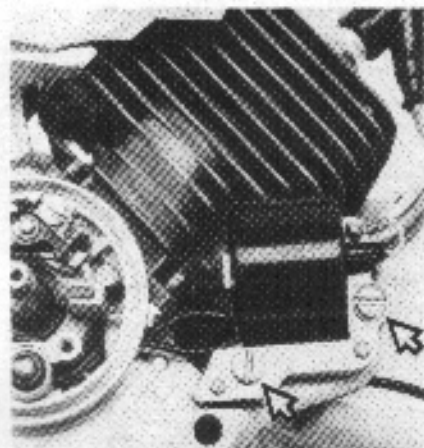

#### 4.9.7 Removal of Ignition Armature - 031 (030)

Remove handle frame and fan housing with tank housing (3.5), take off the flywheel (4.8.4). Disconnect ground and primary leads from the contact set (trigger plate). Unscrew the ignition armature (two pan head screws). Take off the ignition armature with primary and ground leads. When the leads are pulled out through the hole in the crankcase the weatherproof grommet comes with them; it must be correctly positioned again during assembly. Remove spark plug terminal from defective ignition armature and transfer it to the new armature.

#### 4.9.8 Installation of Ignition Armature - 031 (030)

Push primary and ground leads through the crankcase hole and secure them to the contact set

Align flywheel and check air gap

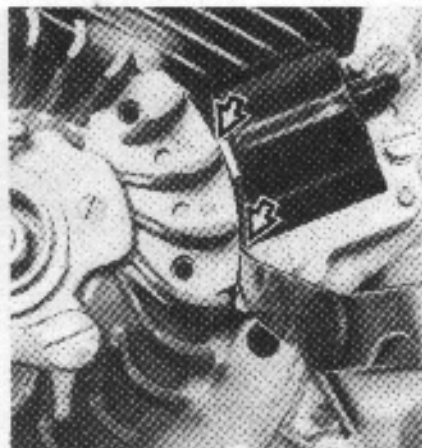

(trigger plate). Press weatherproof grommet into the crankcase hole to achieve a good seal. Secure ignition armature to crankcase with the two pan head screws (only tighten them provisionally at this stage).

Fit the flywheel and align it so that the area in which the magnets are embedded covers half of each of the two armature arms. Place the setting gauge or 0.2 mm gauge sheet between the magnet poles and the armature arms, press the armature firmly against the flywheel and tighten down the pan head screws securely.

Take out the gauge sheet and check the air gap with a feeler gauge. It should be between 0.2 and 0.3 mm.

#### 4.10 Condenser (only machines with breaker-controlled ignition)

##### 4.10.1 Description of Operation

The condenser is wired in parallel with the contact breaker. While the points are opening the primary current is fed briefly to the condenser until it is charged. This ensures that the strength of the current flowing via the contact breaker at this point is only very low and thus suppresses excessive sparking (arcing).

A faulty condenser is often the cause of premature erosion of the contact breaker points and loss of ignition voltage.

##### 4.10.2 Checking the Condenser

There are two methods of checking the condenser's storage capacity:

1. Checking with an ohmmeter.
2. Checking with a Bosch EFAW 106 A tester. Follow the instructions supplied with the unit.

To check with an ohmmeter, remove the flywheel (4.8.2) (4.8.4 for 031/030). Detach condenser connecting lead from the terminal on the contact set. Set ohmmeter to measuring range " $\mu F \times 1$ " ( $\mu F$  = microfarad). Connect one of the two test leads to ground (e. g. cylinder fin) and hold the other test lead against the condenser connection.



Testing the condenser

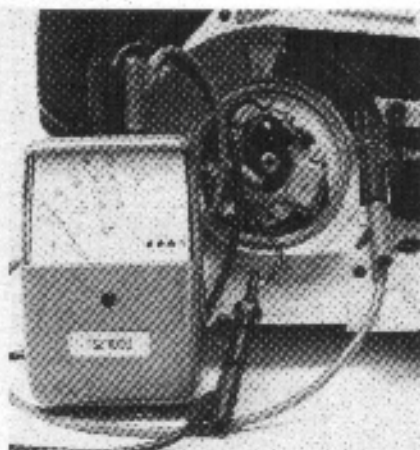

If the condenser is in good condition, it will be charged and the ohmmeter's pointer should briefly move to about  $0.2 \mu\text{F}$ . If this is not the case, the condenser is faulty and a new one must be installed. The condenser must be discharged after this test by shorting the connecting lead to ground.

#### 4.10.3 Replacing the Condenser

When replacing the condenser it is important to ensure that the fixing peg on the condenser is inserted in the appropriate hole in the crankcase. The mounting screw must be securely tightened down. After attaching the connecting lead, tighten down the screw on the contact set. Finish off by refitting the flywheel and fan housing.

Top:  
Insert fixing peg in bore  
Bottom:  
Lever out the condenser

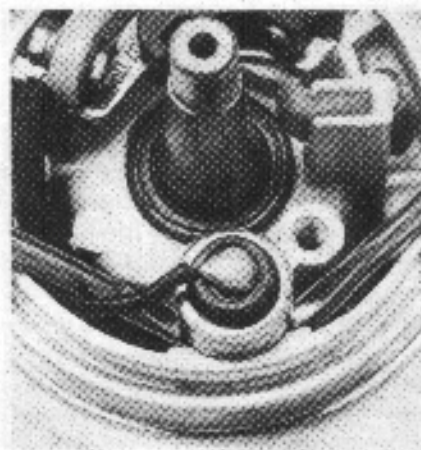
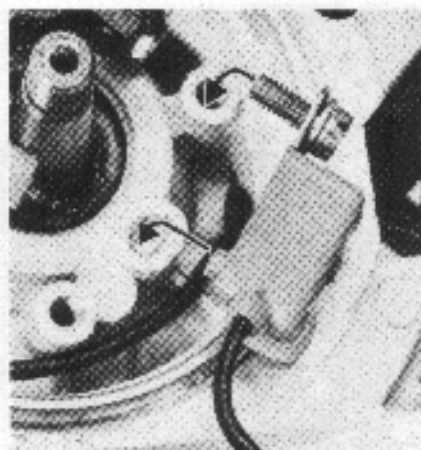

#### 4.10.4 Replacing the Condenser 031 (030)

On this model the condenser is a moderate press-fit in the crankcase. To remove it, use two screwdrivers, one at each side, to lever the condenser upwards and out of its seat. Care should be taken not to damage the leads underneath the condenser (i. e. by pinching them or chafing their insulation). Insert the new condenser with the installing sleeve, tapping it lightly

Installing condenser

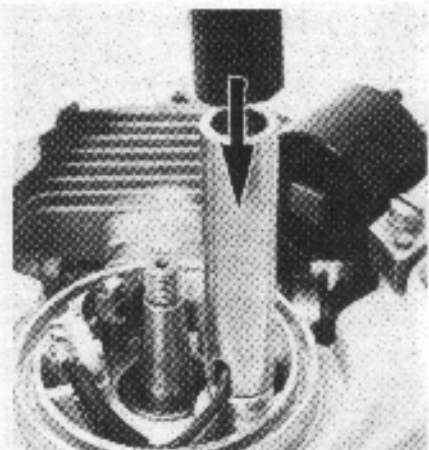

with a hammer. The condenser must be driven in up to the stop.

On 030 models the condenser is located in a separate contact plate which is screwed to the crankcase. The bottom of the condenser must not project more than 0.5 mm at the underside of the contact plate.

#### 4.11 Contact Set (only machines with breaker-controlled ignition)

##### 4.11.1 Construction

The contact breaker set consists of a fixed contact and a moving contact breaker lever which is insulated from ground and connected to the primary connection of the ignition coil, the condenser and the stop switch.

##### 4.11.2 Description of Operation

The contact set is used as a switch which closes the primary circuit and opens it again at the point of ignition. The heel of the contact breaker lever is pressed against the cam on the flywheel hub by a spring. The contact breaker lever is lifted off the contact carrier on each revolution of the flywheel and thus opens the primary circuit. A high tension pulse is produced in the ignition coil by this opening and closing of the circuit which generates the spark at the spark plug.

The breaker point gap, ignition timing and magneto edge gap are interrelated and none of these values can be altered without affecting the others. However, this also means that if one of these values is correct the other two should normally be correct as well. The dominating factor is the magneto edge gap. If variations are experienced in practice, preference should be given to maintaining the correct edge gap which is determined by the position of the magnet in relation to the

Unscrew contact set

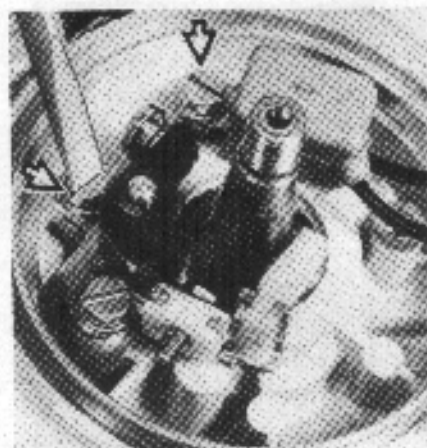

crankshaft and can vary as a result of manufacturing tolerances.

The contact breaker points gradually wear as a result of erosion. Eroded contacts widen the breaker point gap and cause ignition timing to be advanced and the magneto edge gap to be reduced. Partly eroded contacts can be reset but badly burnt contacts necessitate immediate renewal of the complete contact set.

Top:  
Insert fixing peg in bore  
Bottom:  
Setting cam 11138930505 in position

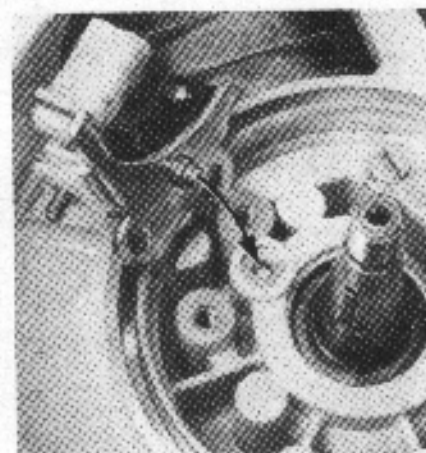

##### 4.11.3 Replacing the Contact Set

Remove the flywheel (4.8.2). Unscrew hexagon nut at lead terminal and take off the leads. Remove the two contact set mounting screws and lift off the contact set. Fit the new contact set in position, making sure the fixing peg engages the housing bore. Moderately tighten the mounting screws. Reconnect leads on terminal. Push setting cam onto crankshaft. Unscrew the locking screw and turn the crank-



Check breaker point gap with feeler gauge

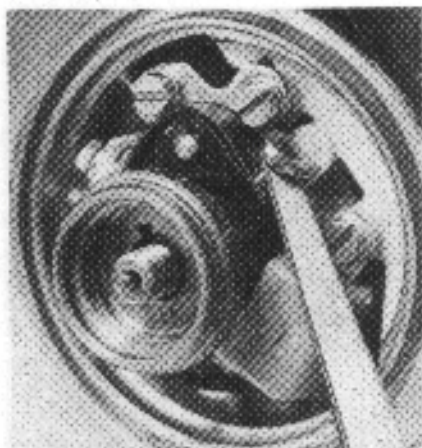

shaft to the top dead center (T.D.C.) position. (Observe piston through spark plug hole.) The cam opens the contact breaker lever fully in this position. Now turn the contact set until a breaker point gap of 0.35–0.4 mm is obtained with a clean feeler gauge.

Tighten the mounting screws and check ignition timing and magneto edge gap. Apply a drop of engine oil to the lubricating felt. Fill the groove behind the heel of the contact breaker lever with grease. Refit the flywheel (4.8.3).

Top:  
Unscrew contact set (031)  
Bottom:  
Remove blanking plugs from setting apertures

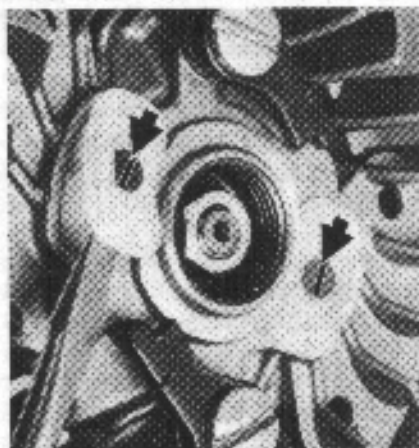
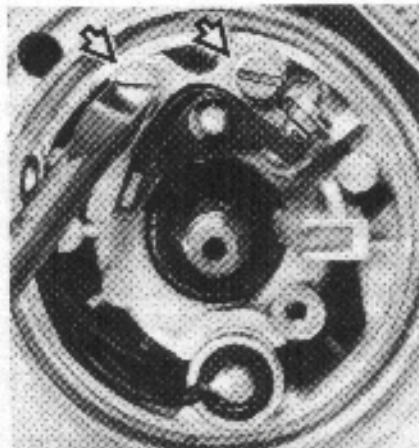

#### 4.11.4 Replacing the Contact Set - 031

Remove the flywheel (4.8.4). Unscrew hexagon nut at lead terminal and take off the leads. Remove the two contact set mounting screws and lift off the contact set. Fit the new contact set in position, making sure the fixing peg engages the housing bore. Moderately tighten the mounting screws. Reconnect leads on terminal. Remove both blanking plugs from the setting

Check breaker point gap through setting aperture

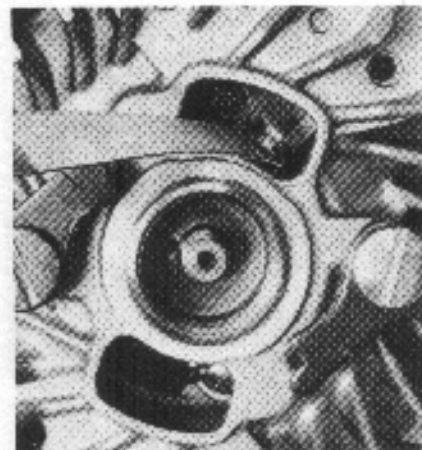

apertures in the flywheel. To do this, loosen each of the counter-sunk self-tapping screws about 2 turns and lever out the blanking plugs with a screwdriver. Fit the flywheel on the crankshaft. Take out the locking screw and turn crankshaft to the top dead center (T.D.C.) position. (Observe piston through spark plug hole.)

The cam opens the contact breaker lever fully in this position. Now turn the contact set until a breaker point gap of 0.35–0.4 mm is obtained with a clean feeler gauge. Tighten the mounting screws securely. Check ignition timing and magneto edge gap.







## 4.13 Ignition Timing

Mounting trigger plate on 031

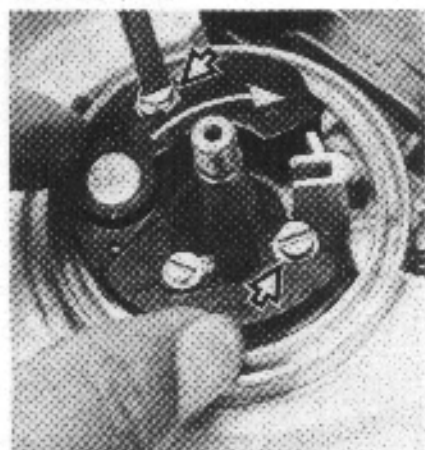

To improve operational reliability in damp conditions we recommend that the terminal screw be coated with Elastosil, part number 07838200110. Refit the flywheel (4.8.3).

### 4.12.4 Replacing the Trigger Plate - 031

Remove the flywheel (4.8.4). Other operations as described in 4.12.3. When mounting the trigger plate, first tighten the pan head screws provisionally, then turn the trigger plate clockwise and finally tighten the pan head screws while holding the trigger plate in that position. Refit the flywheel (4.8.5).

The ignition timing on machines with breaker-controlled ignition systems must be set to 2.1 to 2.3 mm before T.D.C. (top dead center) or to 2.0 to 2.3 mm on the 031 (030). This means that the moving contact should just begin to lift off the fixed contact when the crankshaft is in this position. The contact breaker points should be fully open when the crankshaft is in the T.D.C. position and the gap must be 0.35–0.40 mm.

On electronic ignitions the timing is fixed at 2.7 mm before T.D.C. at 8,000 rpm and is not adjustable. However, in view of the permissible tolerance in the electronic circuit, it may vary between 2.5 and 2.9 mm before T.D.C. at 8,000 rpm.

As there is no mechanical wear in the electronic system the ignition timing never changes during operation. An internal fault in the circuit can, however, alter the switching point to such an extent that, although the spark test is still positive, the ignition timing is outside the permissible tolerance. This will detrimentally affect engine starting and running behavior.

Ignition timing unit connected



### 4.13.1 Checking Breaker-Controlled Ignition

Remove the fan housing. Unscrew the hexagon nut from the stop switch and take off the instruction and cover plates.

Turn stop switch through 90° and withdraw it forwards from housing. Pull ground lead out of switch and connect one test lead of ignition timing unit to the lead plug. Con-

Timing marks must line up

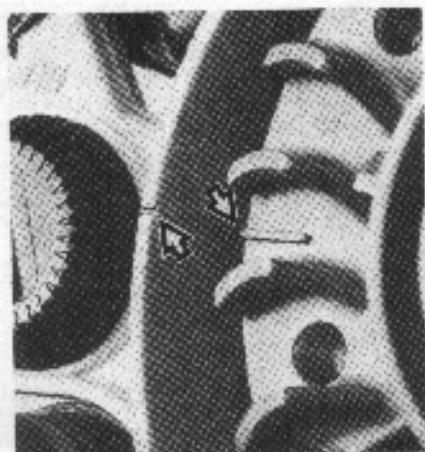

nect other test lead to ground. Switch on the ignition timing unit. Turn flywheel slowly in engine's normal direction of rotation (counter-clockwise) and beyond the top dead center position until the indicator lamp on the timing unit lights up.

The contact breaker points open at this point. The timing marks on the flywheel and crankcase must be exactly in alignment. If this is not the case the ignition must be re-timed. If ignition timing is found to be correct, reassemble the machine in the reverse sequence.

#### 4.13.2 Adjusting Breaker-Controlled Ignition

Remove the fan housing and the flywheel (4.8.2). Take off the handle frame (3.3). Fit setting cam on crankshaft in place of flywheel. Unscrew the hexagon nut from the stop switch and take off the instruction and cover plates.

Pull ground lead out of the switch and connect one test lead of ignition timing unit to lead plug. Connect other test lead to ground. Screw holder of ignition timing unit into the spark plug thread. Fit extension on dial gauge tracer pin.

Slowly insert dial gauge in holder. Turn setting cam in engine's normal direction of rotation (counter-clockwise) until the dial gauge pointer stops moving. Turn bezel of dial gauge so that pointer lines up with zero on scale. Now turn setting cam about  $\frac{1}{4}$  of a crankshaft revolution backwards.

Turn setting cam in engine's normal direction of rotation until the dial gauge shows a mean value of 2.2 mm. Switch on the timing unit. Loosen the contact set and turn it until the indicator lamp on the timing unit just begins to light up. Firmly tighten down the contact set mounting screws.

Top:  
Holder, dial gauge and tracer  
pin extension  
Center:  
Dial gauge in spark plug hole  
Bottom:  
Ignition timing unit ready for test

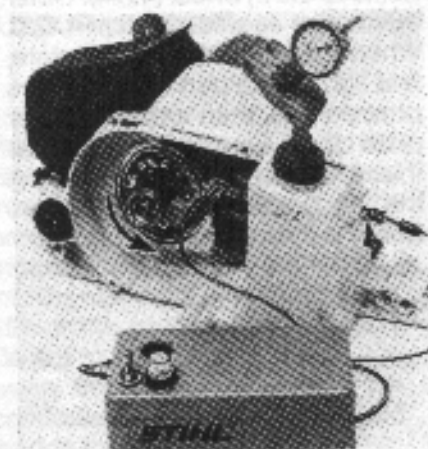
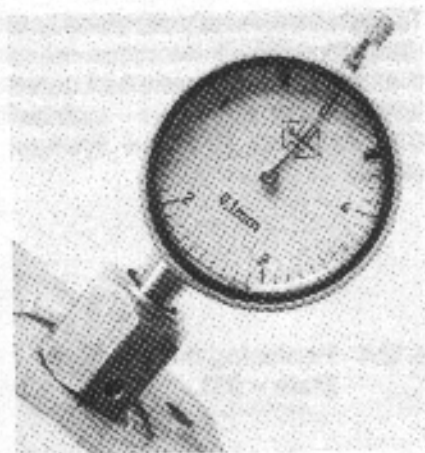
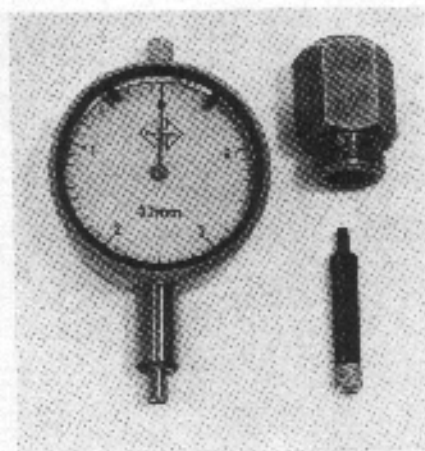



Turn setting cam clockwise



Recheck ignition timing by turning the setting cam about a  $\frac{1}{4}$  of a crankshaft revolution backwards (clockwise). Then turn the setting cam in the engine's normal direction of rotation until the indicator lamp lights up again.

The dial gauge should now show a reading of between 2.1 and 2.3 mm before T.D.C. The contact breaker gap must be 0.4 mm and the magneto edge gap between 4.5 and 8.5 mm. If the magneto edge gap is outside this tolerance the ignition timing will have to be altered until it is within the given tolerance.

Finish off by removing the test equipment and reassembling the other parts in the reverse sequence.

Checking breaker-controlled ignition on 031

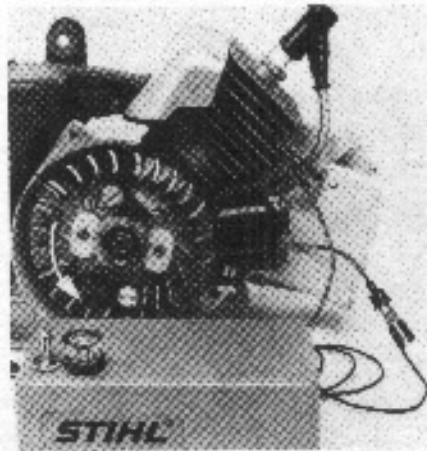

#### 4.13.3 Checking Breaker-Controlled Ignition - 031

Expose the cylinder (3.5). Pull ground lead out of the switch and connect one test lead of ignition timing unit to lead plug. Connect other test lead to ground. Switch on the ignition timing unit. Slowly turn flywheel in engine's normal direction of rotation (counterclockwise) and beyond the top dead center position until the indicator lamp on the timing unit lights up.

The contact breaker points open at this point. The timing marks on the flywheel and crankcase must be exactly in alignment. If this is not the case the ignition must be re-timed. After completing the adjustment, reassemble the machine in the reverse sequence.

Top:  
Timing marks must line up  
Bottom:  
Loosen and press out blanking plugs



#### 4.13.4 Adjusting Breaker-Controlled Ignition - 031

Expose the cylinder. Remove both blanking plugs from the flywheel setting apertures. To do this, loosen the countersunk self-tapping screws about 2 turns and use a screwdriver to lever out the blanking plugs. Pull ground lead out of switch and connect one test lead of ignition timing unit to lead plug. Connect other test lead to ground. Screw holder of ignition timing unit

Top:  
Dial gauge and tracer pin in position  
Bottom:  
Release mounting screws

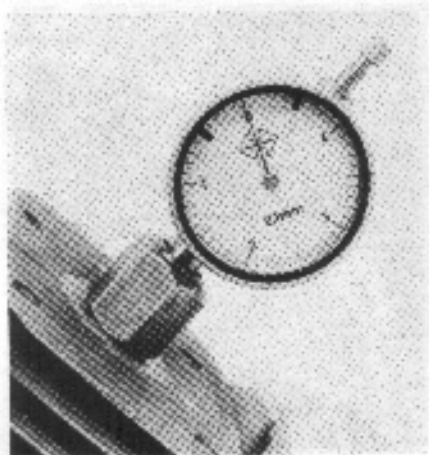

Top:  
Turn flywheel in engine's normal  
direction of rotation  
Bottom:  
Check breaker point gap

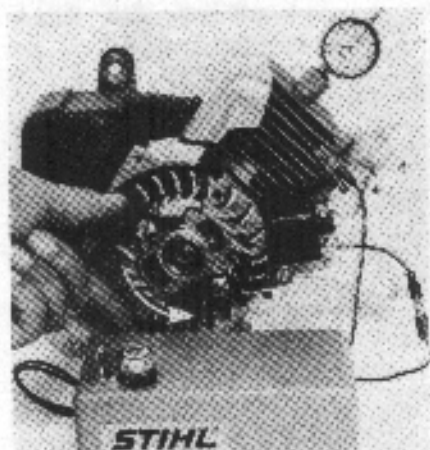

If the breaker point gap is too wide the ignition will be too far advanced. Similarly, if the gap is too narrow ignition timing will be retarded.

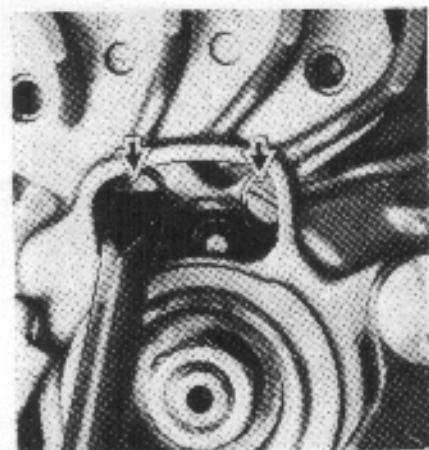

into the spark plug thread. Fit extension on dial gauge tracer pin.

Turn flywheel to gain access to the two contact set mounting screws. Loosen the mounting screws slightly so that the contact carrier can just be moved, but still held in any position by the mounting screws. Turn flywheel in engine's normal direction of rotation (counterclockwise) until the dial gauge pointer stops moving. Check breaker point gap with a feeler

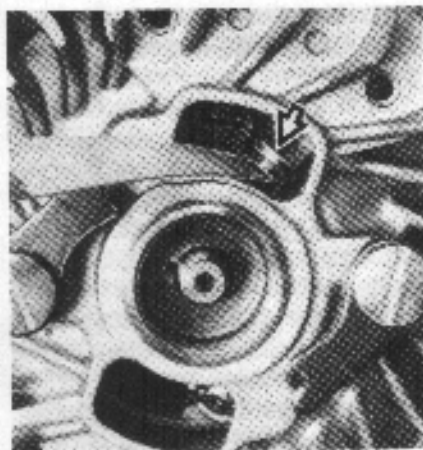

gauge and correct to specified value if necessary. Retighten the mounting screws. Switch on the ignition timing unit. Turn flywheel about  $\frac{1}{2}$  a revolution backwards and then forwards in the engine's normal direction of rotation until the dial gauge indicates a mean value of 2.1/2.2 mm.

The indicator lamp must just begin to light up in this position. If this is not the case, repeat the adjusting and testing procedure.

#### 4.13.5 Adjusting Breaker-Controlled Ignition - 030

On the 030 the contact carrier is pivot-mounted on a contact plate which itself is pivot-mounted in the crankcase. This arrangement enables the breaker point gap to be correctly set with the flywheel removed.

Refit the flywheel. Loosen the contact plate mounting screws through the apertures in the flywheel. The contact plate can now be turned in order to set ignition timing exactly. Carry out this adjustment as described in chapter 4.13.5.



Timing light



Top:  
Setting flange 00008504000  
Bottom:  
Setting flange in position

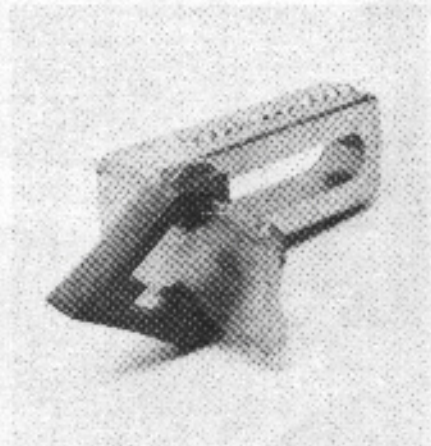

Top:  
Dial gauge fitted, piston at T.D.C.  
Center:  
Piston turned to 2.7 mm  
Bottom:  
Timing mark applied



#### 4.13.6 Checking Electronic Ignition

Contrary to the breaker-controlled ignition, the ignition timing on breakerless ignition systems cannot be checked statically, i. e. it must be checked by means of a stroboscopic timing light with the engine running.

The Bosch stroboscope ET Z 003 (Bosch order number 0684100300) and Bosch timing lights EFAW 180 (Bosch order number 0681101103) and EFAW 185 (Bosch order number 0681101102) are particularly suitable for this purpose.

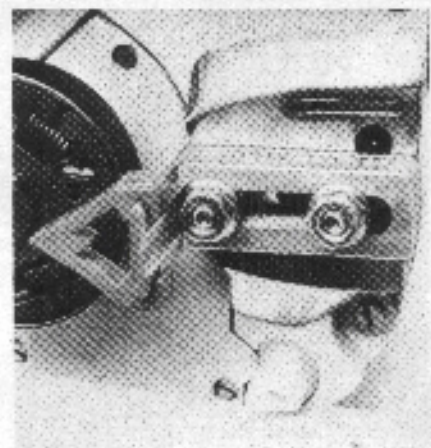

Turn the crankshaft backwards (clockwise) until the dial gauge shows a reading of 2.7 mm. Use a felt pen or similar marker to draw a line on the clutch in line with the arrow point of the setting flange.

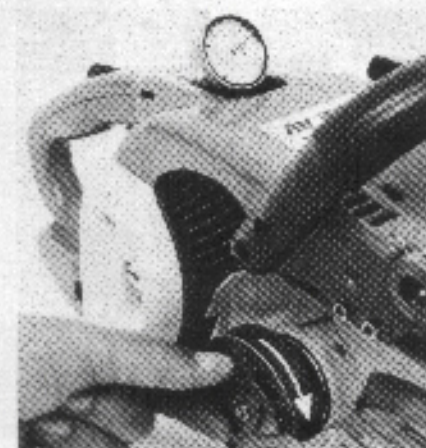

Now slip the setting flange (special tool) onto the bar mounting studs and secure it with the collar nuts. Bring the piston to the T.D.C. position and set the dial gauge to "0".

Refit the spark plug and connect the timing light between the spark plug and spark plug terminal. Start the engine. Set the engine speed to 8,000 rpm at the idle speed ad-

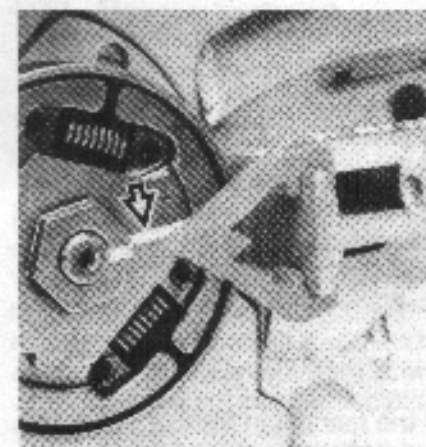

Test set up with timing light

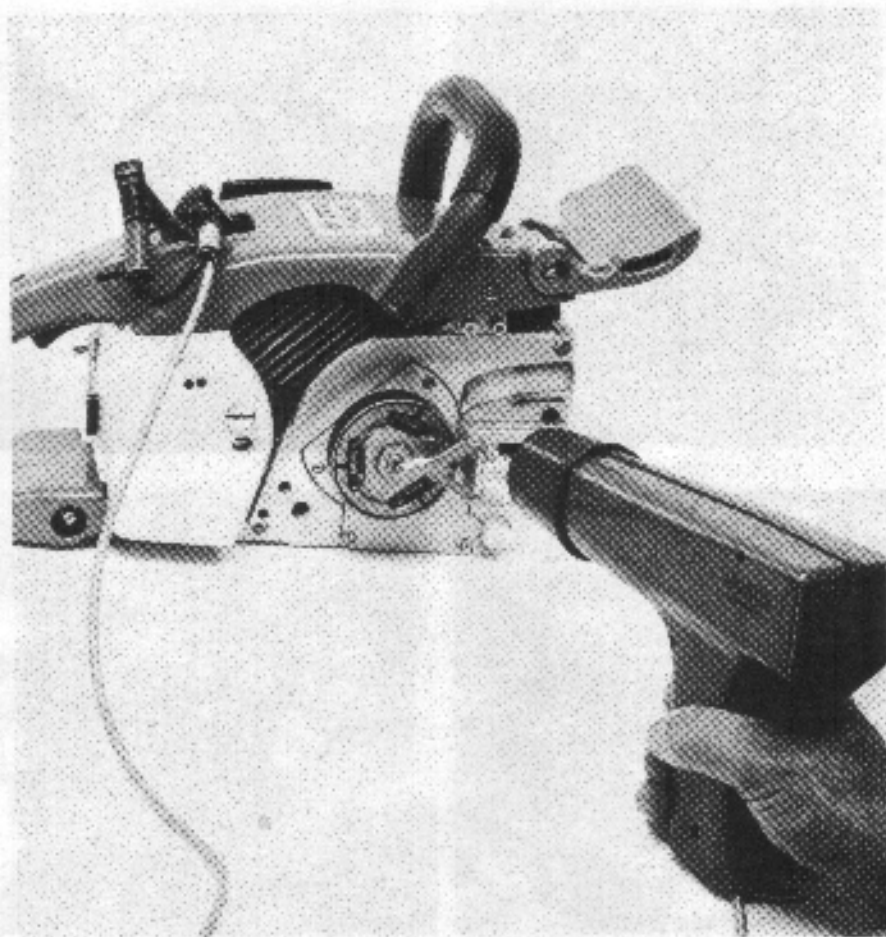

justing screw (use a revolution counter).

**If the timing light is now directed at the timing mark, the mark should appear to be in alignment with the point of the setting flange if ignition timing is correct.**

If the mark is in front of the arrow point (above) in the engine's direc-

tion of rotation, ignition timing is too far advanced. If the mark is behind (below) the arrow point, ignition timing is retarded.

Timing can be corrected if only slightly out of adjustment. Large variations, however, indicate that the trigger plate is faulty and must be replaced.

#### 4.13.7 Correcting Electronic Ignition

Ignition timing is preset by the position of the keyway and key, but it can be varied very slightly.

The key which locates the flywheel has a slight clearance in its seat in the crankshaft as a result of manufacturing tolerances. It is therefore possible to alter the position of the flywheel very slightly in both directions.

If ignition timing is too far advanced, the flywheel should be moved to the right (opposite to engine's normal direction of rotation) within the keyway tolerance and firmly held in that position while tightening down the hexagon nut.

If timing is not advanced enough, turn the flywheel to the left (engine's normal direction of rotation) and hold it in that position while tightening down the hexagon nut.

This is the only method available for bringing about a minor change in timing on the electronic ignition system. No other adjustment facility is provided.



#### 4.14 Magneto Edge Gap (breaker-controlled ignition only)

Magneto edge gap

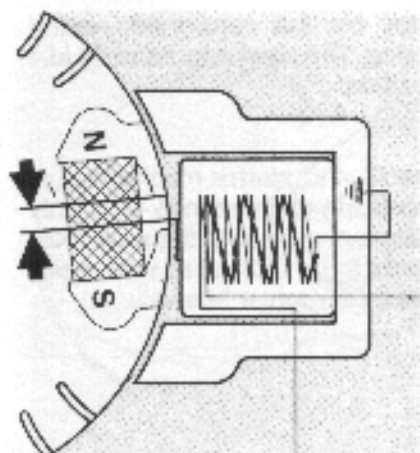

The position of the magnet at the point of current interruption, i. e. ignition, is called magnet breakdown and is referred to in terms of the magneto edge gap. The magneto edge gap is, therefore, the distance between the trailing edge of the north pole shoe and the left-hand edge of the center armature when the contact breaker points begin to open. This distance is 4.5 to 8.5 mm.

The magneto edge gap has a decisive influence on the performance of the ignition system. If it is too large the ignition voltage during starting will be too low; however, if it is too small, the engine will misfire at high speed.

If the ignition is properly timed the magneto edge gap will automatically be correct because the two factors are interrelated. However, variations may occur through the accumulation of upper manufacturing tolerances. The edge gap should, therefore, also be checked

Checking magneto edge gap  
with timing unit

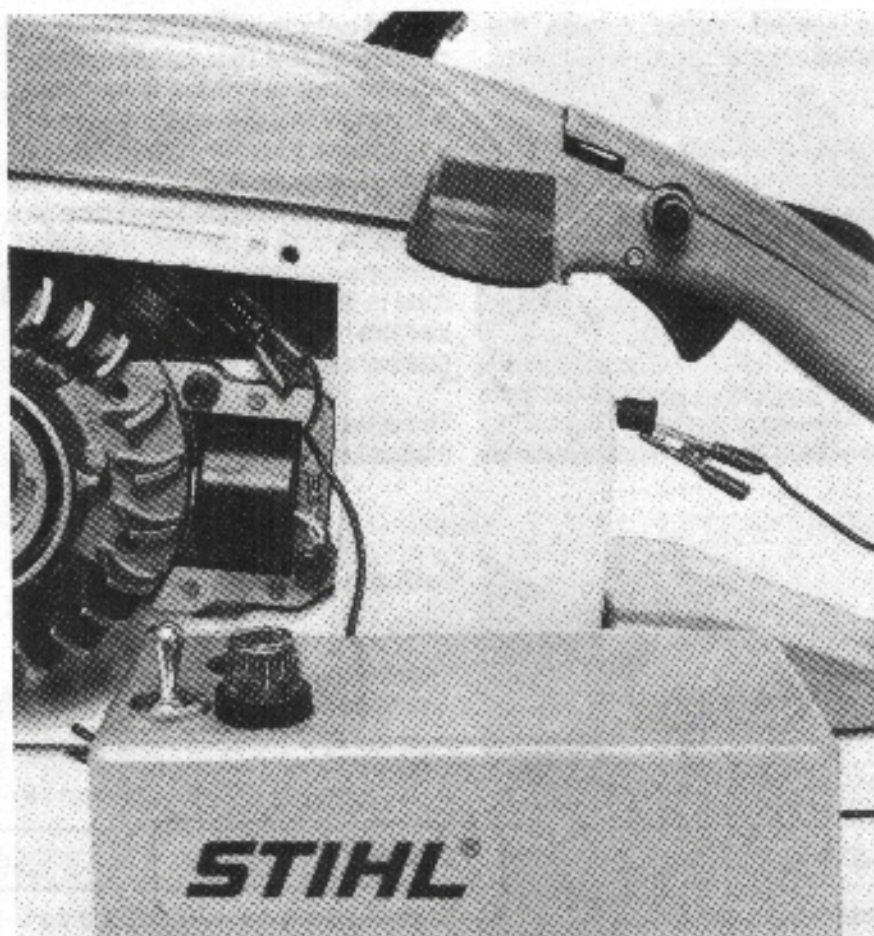

whenever the ignition timing is adjusted. Preference should always be given to maintaining the correct edge gap even if this means that there are minor discrepancies in ignition timing and the contact breaker gap.

To check the edge gap, first follow the procedure for checking ignition timing on breaker-controlled ignition (4.13.1). The magneto edge gap should then be measured at the moment the timing unit's indicator lamp lights up (ignition point).

#### 4.14.1 Magneto Edge Gap – 031 (030) (breaker-controlled ignition only)

See chapter 4.14.

##### Difference:

Magneto edge gap 3.5–7.5 mm. The magneto edge gap is the distance between the trailing edge of the north pole shoe to the left-hand edge of the outer armature when the contact breaker points begin to open.

## 5. REWIND STARTER

### 5.1 Construction and Operation

The rewind starter rotates the crankshaft and starts the engine.

The main components of the rewind starter mechanism are the fan housing with rope rotor mounting, starter rope with grip, rope rotor, rewind spring and starter pawl.

The rewind starter mechanism is mounted on the starter post in the fan housing, directly in front of the flywheel. The starter rope, which is

wound onto the rope rotor by the preload of the rewind spring, rotates the rotor when the starter grip is pulled. The pawl which is pivoted-mounted in the rope rotor is thus swung upwards by the fixed spring clip and engages in one of the six detents in the flywheel hub. The torque produced by the starter rope is thus transmitted positively via the flywheel and turns the crankshaft.

The withdrawn starter rope is automatically rewound onto the rope

rotor by the tensioned rewind spring. The pawl returns to its idle position.

The rewind starter mechanism is practically maintenance-free. Only the bearing bush of the rope rotor needs to be lubricated with resin-free oil at regular intervals.

### 5.2 Troubleshooting Chart

Fault	Cause	Remedy
Starter rope broken	Rope pulled out too vigorously as far as stop or not pulled vertically	Replace starter rope
Rewind spring broken	Spring overtensioned – no reserve when rope is fully extended	Replace rewind spring
Starter rope can be pulled almost without resistance (crankshaft does not turn)	Guide peg on pawl or pawl itself is worn Spring clip fatigued	Fit new pawl Replace spring clip
Starter rope difficult to pull and rewinds very slowly	Rewind starter very dirty (dusty conditions)  Lubrication oil on rewind spring becomes viscous at very low outside temperatures (spring windings stick together)	Thoroughly clean rewind starter  Apply a little paraffin to the rewind spring, then pull rope carefully several times until normal action is restored



## 5.3 Removal of Rope Rotor

Top:  
Component parts of 032 rewind starter  
Bottom:  
Remove spring clip

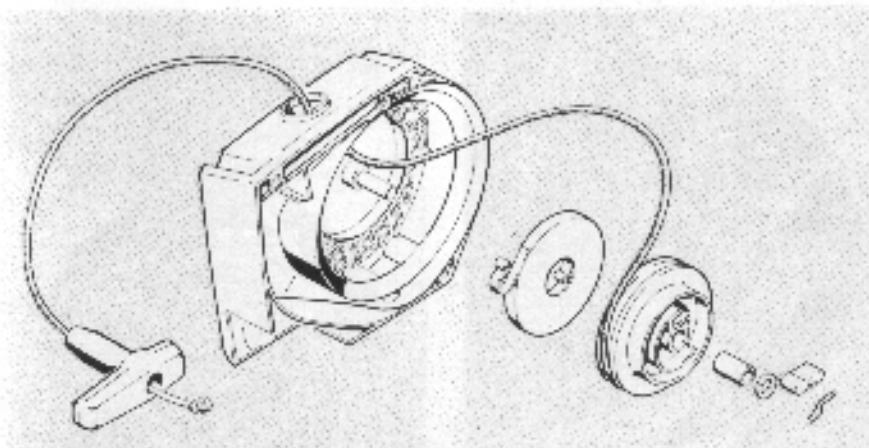

Top:  
Simple knot in rope rotor  
Center:  
Special knot in starter grip  
Bottom:  
Engage gap on spring loop

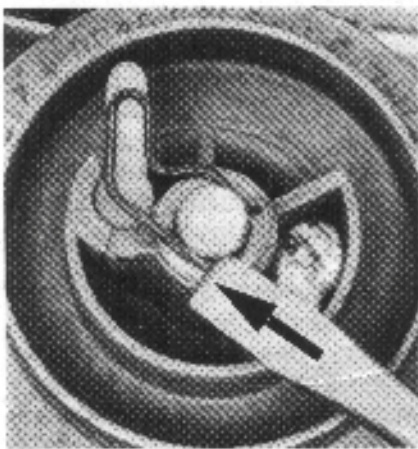
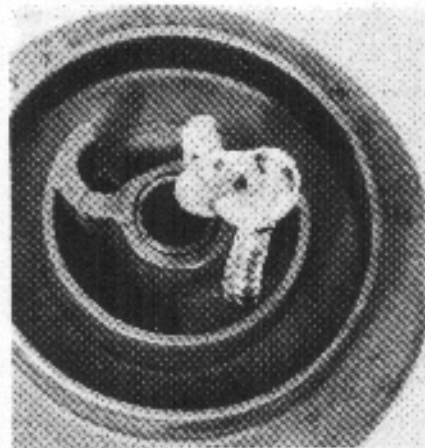

### 5.3.1 Visual Inspection

**Pawl:** Examine for wear on guide peg and front radius.

**Spring housing:** Make sure housing is not dirty; clean if necessary.

**Rope guide bush:** Is bush loose in its housing seat?

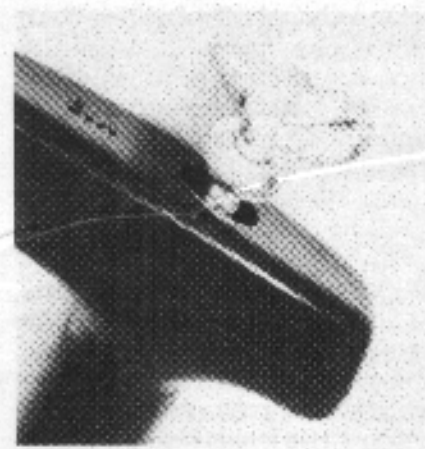

Remove the fan housing. Release tension on rewind spring. To do this, pull starter rope partly out of the housing, hold the rope rotor firmly and take off two or three turns of the starter rope. Slowly let go of the rope rotor.

There will, of course, be no preload on the rewind spring if the starter rope is broken. Now take the spring clip carefully off the starter post. Remove the washer and rope rotor from the post.

### 5.3.2 Replacing the Starter Rope

Pull rope rotor off the starter post. See chapter 5.3. Remove rope residue from the rope rotor. Thread a new starter rope through the rope rotor and secure it with a simple overhand knot. Push the other end of the rope through the underside of the rope bush in the fan housing and through the starter grip and secure it with a special knot. Do not wind the starter rope onto the rope

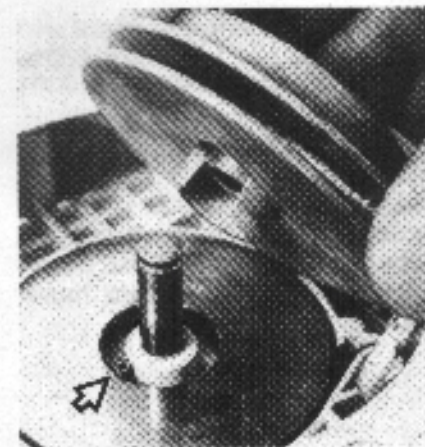

Peg must be inside spring clip

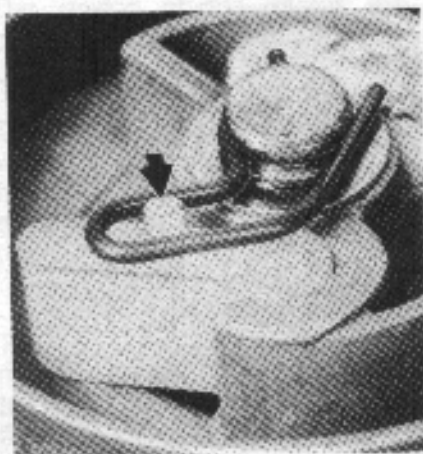

rotor. Lubricate the bearing bush of the rope rotor and the annular groove in the post with a little resin-free oil. Position rope rotor on the starter post so that the inner loop of the rewind spring engages in the gap in the annular rib.

Fit the pawl in the rope rotor. Place washer in position and push the spring clip onto the starter post. The spring clip must point in the clockwise direction and the pawl's peg must be inside the spring clip.

**Note:**

Spring clip must be in perfect condition.

Carry out functional test: Turn rope rotor clockwise; pawl should move outwards. Turn rope rotor counterclockwise; pawl should move inwards.

Fit spring loop over cast lug

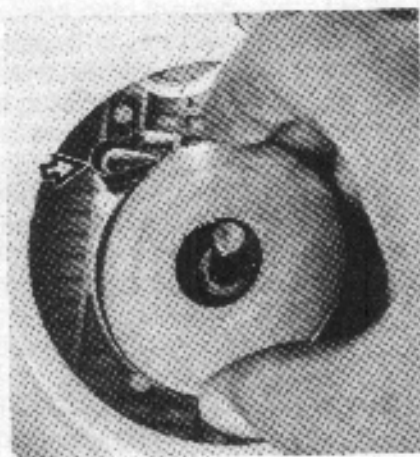

### 5.3.3 Replacing the Rewind Spring

Remove rope from the starter post. See chapter 5.3. Take spring housing with rewind spring, and any spring pieces, out of the fan housing.

Lubricate the rewind spring with non-resinous oil and fit it together with the spring housing (bottom upwards) in the fan housing. Position the outer spring loop over the cast lug on the fan housing.

Refit the rope rotor (5.3.2)

**Note:**

If the spring comes out of the spring housing and uncoils during installation, refit it in the counterclockwise direction, starting with the outer end and working inwards. Then refit the rope rotor.

Tensioning the rewind spring

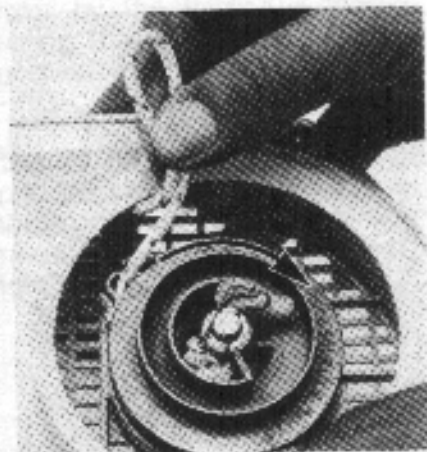

#### 5.3.3.1 Tensioning the Rewind Spring

Turn the rope rotor to wind the starter rope counterclockwise onto the rotor until the starter grip is about 20 cm from the fan housing.

Make a loop in the rope at the rope rotor and use it to rotate the rope rotor three turns clockwise and then hold rope rotor in that position.

Pull twisted rope through rope guide bush and straighten it out. Let go of rope rotor and allow starter rope to rewind slowly onto the rotor.

Refit fan housing.



Starter grip firmly seated in rope bush

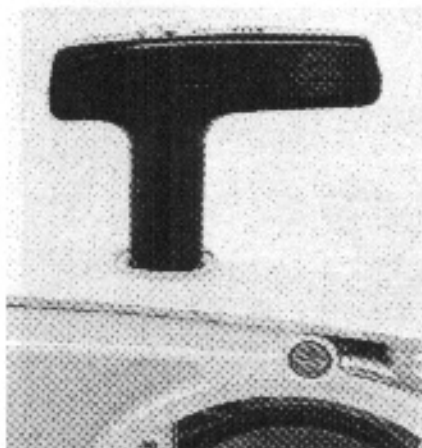

Rope guide bush

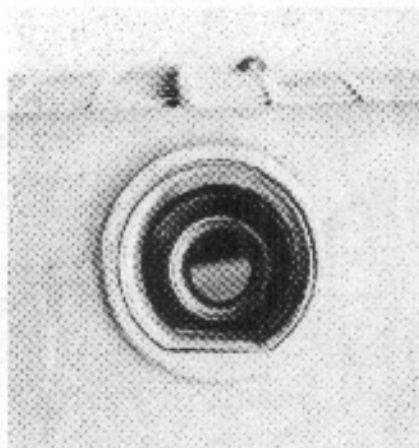

Top:  
Installing tool 00008902201  
Bottom:  
Filling rope bush

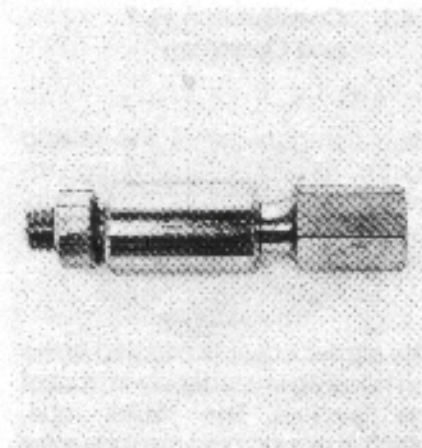
**Note:**

The rewind spring is correctly tensioned when the starter grip sits firmly in the rope bush without hanging to one side. If this is not the case, tension the rewind spring by one more turn of the starter rope.

When the starter rope is fully extended it must still be possible to rotate the rope rotor at least another half turn before maximum spring tension is reached. If this is not the case, hold the rope rotor firmly and take off one turn of the rope.

**Do not overtension the rewind spring as this will cause it to break.**

**5.3.4 Starter Rope Guide Bush**

The wear on the guide bush is increased considerably if the starter rope is pulled sideways. The wall of the bush eventually wears through, becomes loose and must be replaced.

**5.3.4.1 Replacing the Rope Guide Bush**

Remove the fan housing. Unscrew the deflector and pull the starter rope out of the rope guide bush. Lever the rope bush out of the fan housing with a screwdriver. Fit the new bush in its housing seat. Insert the threaded end of the installing tool through the bush from the inside of the fan housing. Fit the thrust sleeve and hexagon nut. Tighten the hexagon nut to fold

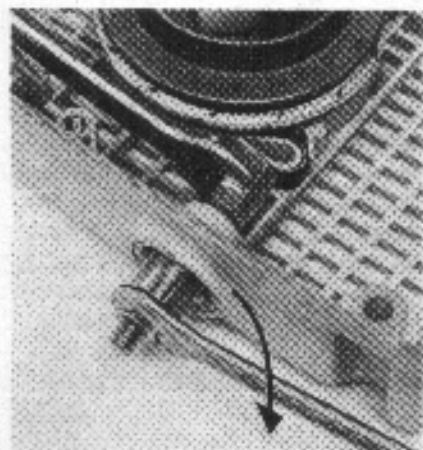

over the lower end of the rope bush until it is firmly seated.

## 5.4 Rewind Starter - 031 (030)

### 5.4.1 Construction and and Operation

Main components of the rewind starter: Starter cover with rope rotor mounting, starter rope with grip, rope rotor, rewind spring and starter pawls.

The starter cover is situated in the fan housing immediately in front of the flywheel. The starter rope, which is wound onto the rope rotor by the preload of the rewind spring, rotates the rotor when the starter grip is pulled. The rope rotor recesses engage in the pawls which are pivot-mounted on the flywheel. The torque produced by the starter rope is thus transmitted positively via the flywheel to the crankshaft and causes it to turn. Once the engine is running the

Component parts of 031 rewind starter

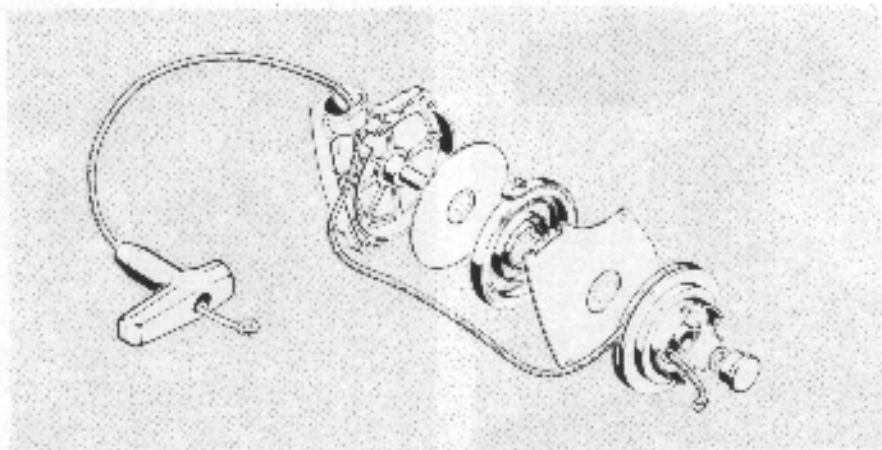

centrifugal force presses the pawls outwards and allows the flywheel to turn independently.

The withdrawn starter rope is automatically rewound onto the rope rotor by the tensioned rewind spring. The rewind starter me-

chanism is practically maintenance-free. Only the bearing bush of the rope rotor needs to be lubricated with non-resinous oil at regular intervals.

### 5.4.2 Troubleshooting Chart

Fault	Cause	Remedy
Starter rope broken	Rope pulled out too vigorously as far as stop or not pulled vertically	Replace starter rope
Rewind spring broken	Spring overtensioned - no reserve when rope is fully extended	Replace rewind spring
Starter rope can be pulled almost without resistance (crankshaft does not turn)	Torsion spring broken	Replace torsion spring
	Pawls worn	Replace pawls



Unscrew starter cover

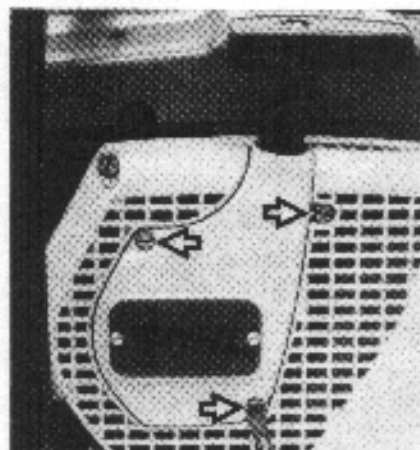

#### 5.4.3 Removal of Rope Rotor

Unscrew the starter cover from the fan housing. Release tension on rewind spring. To do this, pull starter rope partly out of the housing, hold the rope rotor firmly and unwind two or three turns of the starter rope. Slowly release rope rotor. There will, of course, be no preload on the rewind spring if the starter rope is broken. Remove the protective cap and retaining washer from the starter post.

#### 5.4.4 Visual Inspection

**Pawl:** Wear in engagement area.

**Starter cover:** Make sure cover is not dirty; clean if necessary.

**Rope guide bush:** Is bush loose in its housing seat?

**Shim:** Replace worn Resitex shims.

Position rope rotor correctly

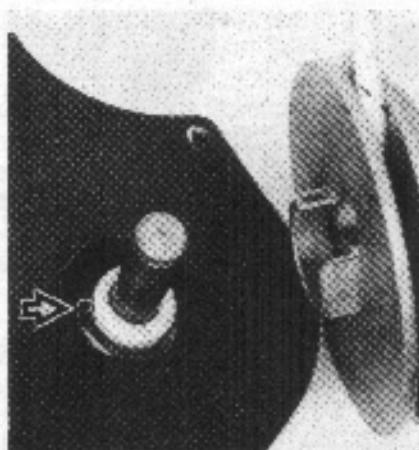

#### 5.4.5 Replacing the Starter Rope

Pull rope rotor off the starter post. Remove rope residue from the rope rotor. Thread a new starter rope through the rope rotor and secure it with a simple overhand knot. Push the other end of the rope through the rope guide bush in the starter cover and through the underside of starter grip and secure it with a special knot. Lubricate the bearing bush of the rope rotor with a little non-resinous oil. Fit rope rotor on the starter post so that the inner loop of the rewind spring engages in the gap in the annular rib. Fit retaining washer on starter post and push cap into position.

New rewind spring

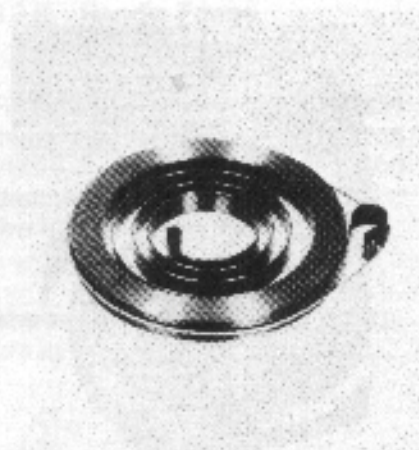

#### 5.4.6 Replacing the Rewind Spring

Pull the rope rotor off the starter post.

Take off the Resitex shim. Carefully lever the rewind spring out of the starter cover with a screwdriver. Take care when fitting the new spring in position (it is under tension).

The replacement spring is supplied ready for installation and is held together by a wire strap. The wire strap is pushed off the spring during installation. If the rewind spring jumps out and uncoils during installation, it should be refitted in the starter cover in the clockwise direction, starting with the outer end and working inwards. Lubricate the spring with a little oil and fit the Resitex shim. Fit the rope rotor.

Wind starter rope onto rotor

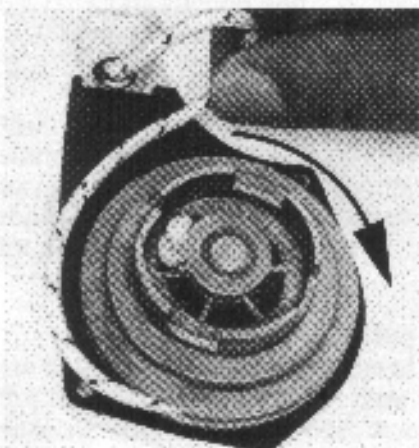

#### 5.4.6.1 Tensioning the Rewind Spring

Wind the starter rope completely onto the rope rotor in the clockwise direction. Then pull out grip about 30 to 40 cm (12–14"). Hold the rope rotor firmly and wind rope another two turns onto the rotor.

**Note:** See chapter 5.3.3.1.

Fit starter cover in the fan housing. To do this, pull the starter grip out slightly so that the pawls engage the recesses in the flywheel hub. Secure starter cover in fan housing with the pan head screws.

Fit starter cover

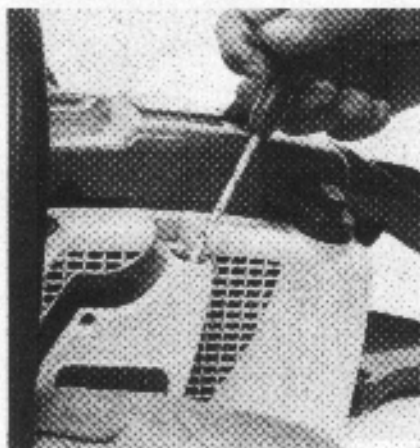

#### 5.4.7 Replacing the Starter Rope Guide Bush

See chapter 5.3.4.1.

### 5.5 Routine Maintenance

If the starter rope action becomes stiff and the rope rewinds very slowly or not completely, it can be assumed that the rewind starter is mechanically in order but caked with dirt. At very low outside temperatures the oil on the rewind spring may thicken and cause the spring windings to stick together. This has a detrimental effect on the function of the rewind starter. In such a case it is sufficient to apply a little paraffin to the rewind spring. Then pull out the starter rope slowly several times until its normal action is restored. If clogged with dirt or resin, the entire rewind starter mechanism, including rewind

Replace pawls



spring, must be removed from the machine. Take special care when removing the spring. Wash all parts in paraffin or clean gasoline.

Lubricate the rewind spring and starter post with oil when reassembling.

### 5.6 Replacing the Pawls and Springs

First remove the fan housing.

Remove oval head screws and take out the pawls, springs and washers. Secure oval head screws with LOCTITE when reassembling. Check freedom of movement of pawls after tightening down the oval head screws.



## 6. AV HANDLE SYSTEM

## 6.1 Construction and Operation

Position of vibration dampers

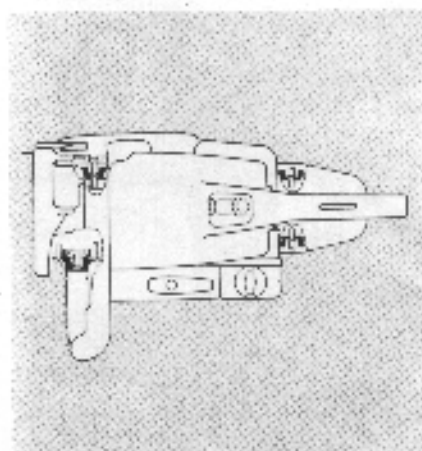

The anti-vibration handle system damps the engine and cutting attachment vibrations to a minimum before they reach the operator. This vibration insulation is achieved by means of resilient joints between the engine and handlebar as well as the handle frame.

These resilient joints consist of rubber elements (vibration dampers) which are screwed to the powerhead. It is essential for correct operation of the AV handle system that the chain saw be used only with completely intact vibration dampers. Brittle or torn vibration dampers should always be replaced in complete sets. It is also important to ensure that the mounting screws are always properly tightened.

## 6.2 Replacing the Vibration Dampers

## 6.2.1 Rear Handle

Remove the two collar screws from the engine. Grip handle frame at rear handle and pull it upwards. Press vibration dampers upwards out of the bores. Reassemble in the reverse sequence.

## 6.2.2 Handlebar

Remove the two pan head screws from the handlebar – below the oil filler cap. Take out the two socket-head screws and lift off the handlebar. Unscrew the collar screw and remove the vibration damper. Fit the new vibration damper in position and provisionally tighten the collar screw. Now hold the handlebar against the machine and line up the screw holes in the vibration damper and the tapped holes in the crankcase.

Hold the vibration damper firmly in this position, lift handlebar away from machine and tighten down the collar screw securely.

Assembly is otherwise a reversal of the disassembly procedure.

## 6.2.3 Handle Frame

Remove collar screw from handle frame and two socket head screws from the crankcase. Push vibration damper forwards and out under the handle frame.

**Important:** Install vibration dampers in stress-relieved condition.

## 6.3 AV Handle System – 031 (030)

See chapter 6.

**Difference:** The vibration damper on the handle frame of the 030 differs from the one on the 032 or 031.

031/032 part number:  
1113 790 9001  
030 part number:  
1113 790 9900.

On the 030 and early 031 machines the vibration dampers are housed in a support on the rear handle and held by a flat head screw.

## 6.3.1 Replacing the Vibration Dampers

Unscrew hexagon nut from the flat head screw. Use a punch to drive the flat head screw out of the support. Replace the vibration dampers.

## 7. ELECTRICALLY HEATED HANDLES

### 7.1 Construction

The electric handle heating system enables the operator to keep a warm and comfortable grip on the handlebar and rear handle at extremely low outside temperatures.

There are heating elements in the rear handle and handlebar, positioned between the tube and grip material. The electricity required to power the heating elements is supplied by a generator. This generator has ten series connected coils on its star-shaped iron core and is screwed to a centring flange in the crankcase behind the flywheel. The heating system's on-off switch is situated on the handle frame.

### 7.2 Description of Operation

As in the case of the ignition system the generation of electrical voltage is achieved by magnetic induction. The ten uniformly spaced induction coils on the periphery of the generator produce not only a voltage pulse on each revolution of the flywheel, but a continuous voltage flow.

The magnitude of this voltage is dependent upon the rotational speed of the flywheel. It reaches approx. 23 Volt at 10,000 rpm and is, therefore – unlike the ignition voltage – not dangerous.

Once the circuit is closed by the switch an alternating current flows via the connecting wire, through the heating element in the rear handle, then the heating element in the handlebar, the switch and via ground to the generator. This current in the heating elements is converted into heat. The generator is rated in such a way that the rear handle and handle are heated to an adequate level when the machine is run at normal working speed. This applies even at extremely low outside temperatures.

The whole heating system is maintenance-free and subject to practically no wear. Damage to the generator, heating elements and wiring can only be caused by external mechanical impact or interference.

### 7.3 Troubleshooting

There are basically two reasons for the failure of the heating system:

1. Electrical circuit broken by wiring or component defect.
2. Short circuit caused by damage to insulation.

Tracing the fault:

Remove the handle cover and disconnect both wires at terminal 1.

Test set up with ohmmeter, terminals 1 and 2

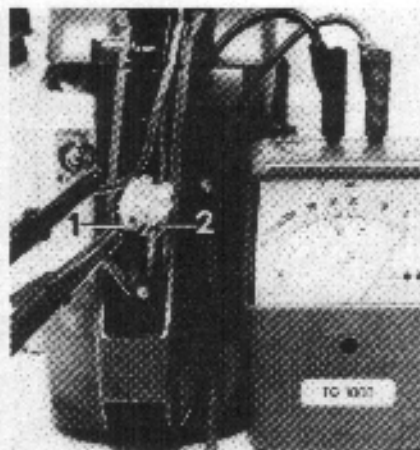

Then connect test leads of the ohmmeter to the wires (either way round).

If the system is in order the ohmmeter should now show a reading between 3.5 and 4  $\Omega$  in measuring range " $\Omega \times 1$ ". If the instrument shows no reading, there is a break in the circuit.

If the ohmmeter shows a reading of less than 3.5  $\Omega$ , one of the components has a short.

In both cases it is necessary to check each component individually.

The following chart shows the test connections and test values.



Component	Connection of measuring instrument (test leads may be connected either way round)		Sp.		Cause	Remedy
	Lead 1	Lead 2		Actual		
Switch	Lead terminal on switch <sup>1)</sup>	Ground on switch	0 <sup>2)</sup>	-	Switch faulty	Replace switch
Heating element in rear handle	Heating wire 1	Heating wire 2	1	appx. 1	Heating element OK	
			-	-	Break in wire, heating element damaged	Replace heating element
			0	0	Short circuit as result of damage to insulation	Insulate damaged area
Heating element in handlebar	Heating wire 3	Ground	2	appx. 2	Heating element OK	
			-	-	Break in wire, heating element damaged	Replace handlebar
			0	0	Short circuit as result of damage to insulation	Insulate damaged area
Generator	Generator lead	Ground	0.6	appx. 0.6	Generator OK	
			-	-	Break in wire, generator damaged	Replace generator
			0	0	Short circuit as result of damage to insulation	Insulate damaged area

<sup>1)</sup> Pull out lead for this purpose <sup>2)</sup> in switch position "0"

## 7.4 Component Parts Removal and Installation

Pull lead off heater switch

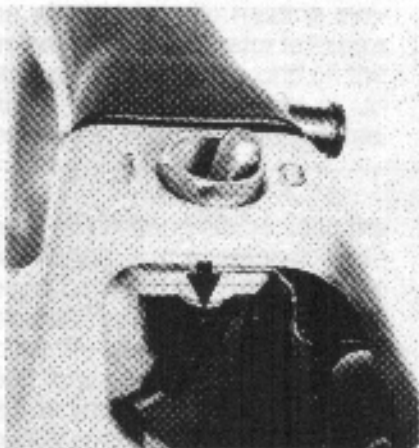

### 7.4.1 Switch

Pull off spark plug terminal and unscrew the spark plug. Use pliers to pull lead off heater switch. Remove nut from switch and take out the switch.

Installation of the switch is carried out in the reverse sequence.

**Note:** The slot in the switch thread must point to the "0" position. Attach ground lead between switch and handle frame. Refit rubber grommet.

### 7.4.2 Heating Element in Rear Handle

Remove securing screw and take off handle cover together with the safety throttle lock. Disconnect heating element wire at terminal

Heating element bonded in position

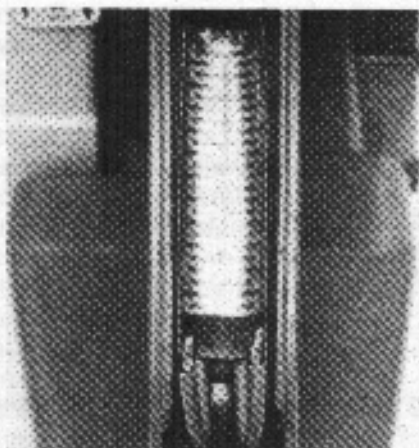

strip. Take clamp and heating element out of the handle.

Install the heating element by reversing the above sequence.

**Note:** The new heating element is self-adhesive. Take off the backing paper and position element in handle so that it locates against the cross rib.

### 7.4.3 Heating Element in Handlebar

The heating element in the handlebar cannot be replaced as a separate unit. If it is faulty the whole handlebar has to be exchanged.

The old handlebar can be used on 032/031 chain saws that have no heated handles.

Take off the handle cover. Pull off the spark plug terminal and unscrew the spark plug. Pull lead off

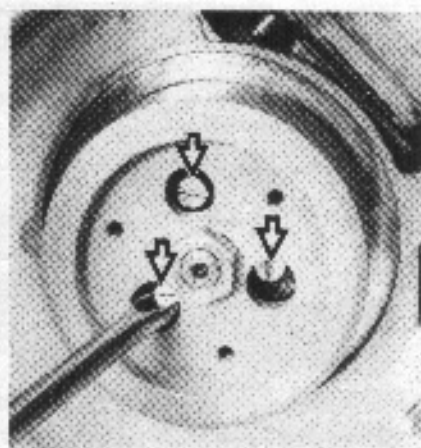
Fit generator with centring tool  
1118 893 3500

heater switch. Disconnect heating element wire at terminal strip. Take the two split pins out of the handle frame. Pull both wires out of the groove in the handle frame and take off the rubber grommet. Unscrew the handlebar at the handle frame and crankcase. Take off the handlebar, pulling both wires out of the bore in the handle frame at the same time.

Assembly of the new handlebar is carried out in the reverse sequence.

### 7.4.4 Generator

Remove the flywheel (4.8.2). Unscrew the three pan head screws from the generator. Take off the handle cover. Disconnect generator lead at terminal 1. Remove the generator and pull connecting lead out of the rubber grommet at the same time.

Take off the intermediate flange. Push the lead of the new generator through the rubber grommet, position it in the handle frame and se-



## 7.5 Heated Handles - 031

Pull off centring tool with puller 1107 890 4500

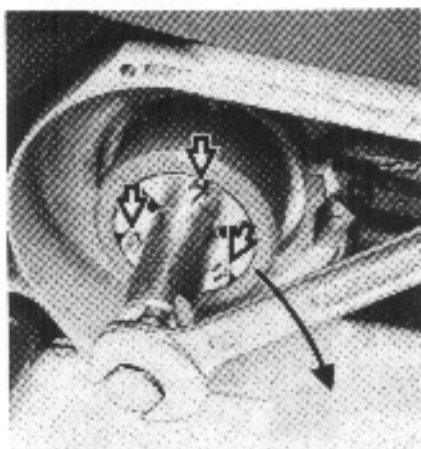

Fit the intermediate flange and secure it to the terminal strip. Fit the intermediate flange.

Place generator on intermediate flange and provisionally tighten the screws. (Make sure the lead is not pinched.)

Fit centring tool on the crankshaft so that the slot in the taper engages over the key. Slightly loosen the centring tool on the M 8 x 1 hexagon nut. Tighten down the generator mounting screws through the holes in the centring tool.

Use the clutch and flywheel puller to pull off the centring tool.

Refit the flywheel (4.8.3).

Component parts of exhaust handle heating

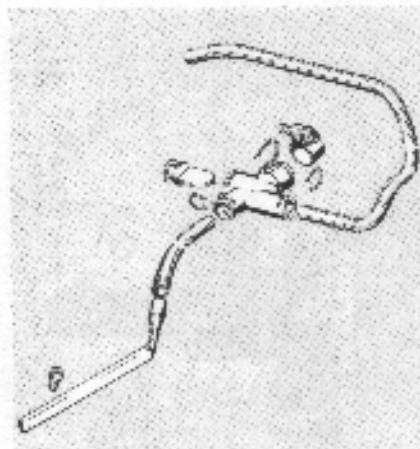

On machines with exhaust handle heating a part of the hot exhaust gases is diverted through tubes to the handlebar and rear handle. This enables the operator to use the saw at extremely low outside temperatures.

### 7.5.1 Construction and Operation

The heating system consists of two flexible metal tubes, one metal end pipe, a manually operated valve and a muffer with an additional stub connection.

The hot exhaust gases pass through the stub connection on the muffer and into a valve which splits the exhaust gas into two streams. These are fed through metal tubes to the handlebar and rear handle. The exhaust gases heat the handles in this process

and are then expelled to atmosphere. A throttle in the valve allows the flow of exhaust gas to the heating tubes to be closed off partly or fully.

### 7.5.2 Troubleshooting

Remove handlebar and handle frame. Unscrew the grub screw and take off the handle cover together with the safety throttle lock. Remove three pan head screws from handle frame. Take out the metal tubes with valve. The pipe can be taken out of the rear handle after removing the other two pan head screws.

Installation is a reversal of the disassembly procedure.

## 8. CHAIN LUBRICATION

A mechanically driven oil pump supplies lubricating oil to the saw chain and guide bar.

## 8.1 Construction

The chain lubrication system consists of the following components:

Chain oil tank (integrated in crankcase), intake line with pickup body, oil pump with drive.

## 8.2 Description of Operation

The oil pump is driven via two spur gears. The driving gear is mounted on the crankshaft and is connected to the clutch drum and cover plate by a press-fitted bearing needle. The driven spur gear is mounted on a shaft in the pump housing and its hub is designed as a single thread worm which drives the pump plunger.

The overall reduction ratio between chain sprocket and pump plunger is 1:23. This means that the pump plunger makes one revolution for every 23 revolutions of the chain sprocket.

The suction and delivery action of the pump is effected by the plunger performing a vertical stroke during each revolution.

Diagram of oil pump

- 1 Spur gear
- 2 Worm
- 3 Pump housing
- 4 Pump plunger
- 5 Control bolt

Intake stroke

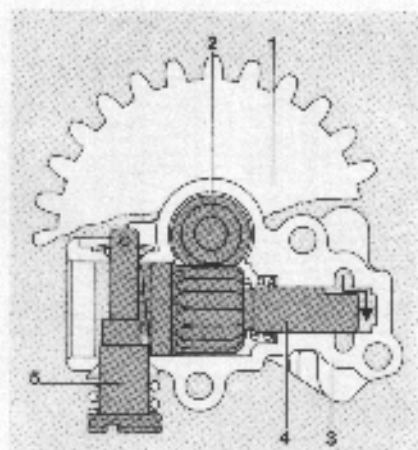

This vertical stroke is brought about by the end of the pump plunger having a helical edge which runs against the control bolt. The tapered shape of the control bolt allows the length of the stroke and thus the feed rate of the pump to be adjusted manually.

The pump plunger moves downwards on its intake stroke and creates a depression at the inlet end. This causes oil to be drawn out of the oil tank and into the pump housing. An oil pocket at the top of the plunger collects the oil at the intake port and transfers it to the outlet port on its upward stroke, thus compressing the oil and forcing it through the outlet port to the bar and chain.

The oil delivery rate is in a fixed linear ratio to the chain speed. This means there is always a sufficient supply of lubricating oil to the bar and chain at all engine speeds. The pump delivery rate is between 8.5 and 11.5 cm<sup>3</sup>/min at 6,000 rpm.

Delivery stroke

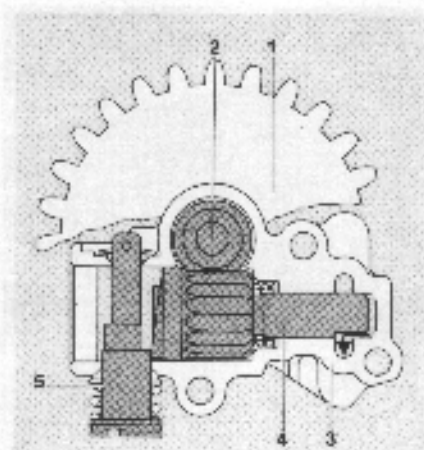

The chain lubricating oil is filtered by the pickup body in the oil tank to prevent any impurities reaching the oil pump.

In order to protect the cutting attachment from unnecessary wear, make sure the oil pump is always in good working order.



## 8.3 Troubleshooting Chart

In the event of difficulties with the chain lubrication system, always investigate the other possible sources of faults before disassembling the oil pump.

Fault	Cause	Remedy
No oil supply to chain	Oil tank empty	Fill up with oil
	Oil inlet hole in guide bar is blocked	Clean oil inlet hole
	Pickup line or pickup body (strainer) blocked or pickup line cracked	Wash pickup line and pickup body (strainer) in clean gasoline and blow out with compressed air; renew if necessary
	Valve in oil tank is blocked	Clean or replace valve
	Teeth on spur gears or worm worn	Install new spur gears or worm
Machine loses chain oil	Bore of pump housing is worn	Replace pump housing
	Worn sealing ring in pump housing	Replace sealing ring
Oil pump delivers insufficient oil	Bore of pump housing is worn	Replace pump housing

### 8.4.1 Construction and Operation

The chain oil tank is an integral part of the crankcase. The elbow fitting, to which the pickup hose and pickup body are connected, ends in the crankcase directly next to the oil pump's intake port. On the oil pump's intake stroke the chain oil is drawn out of the oil tank through the pickup body, pickup line and elbow fitting.

A precondition for correct operation of the oil pump is that the pressure in the pump chamber is lower than that in the oil tank during the intake stroke. However, as the oil tank filler cap seals the oil tank airtight, a depression would normally be created in the oil tank as the oil level drops and negate the action of the oil pump. A valve is installed in the tank wall to prevent this happening and maintain a pressure in the oil tank that is equal to atmospheric pressure. This valve opens at a depression of approx. 0.1 bar, i.e. this means the depression in the oil tank will never be more than 0.1 bar. If the valve is operating correctly. The valve also effectively prevents chain oil leaking from the tank, irrespective of the chain saw's operating position.

Top:  
Pull off pickup hose  
Bottom:  
Hose bell folded back

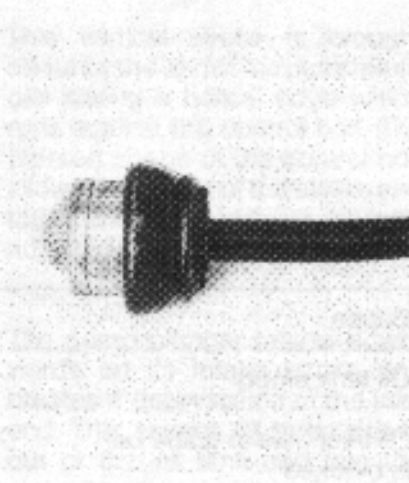

### 8.5.1 Removal and Installation/Repair

Drain the oil tank. Use a suitable pair of pliers to pull the pickup hose off the elbow fitting. Fold hose bell back to the rear and take out the pickup body. Wash the pickup hose and pickup body in clean gasoline and blow them out with compressed air. Use hook (1110 893 8800) to refit pickup hose and push it onto the elbow fitting.

Lever out valve

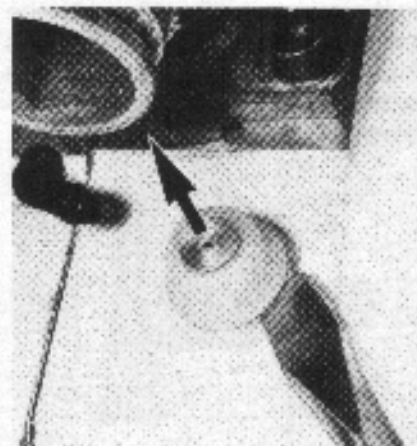

### 8.6.1 Removal and Installation

Remove the handle frame (3.3). Use a screwdriver to lever the valve out of the housing bore. Press in new valve as far as shoulder. Refit the handle frame (3.3).

If the valve is clogged with dirt and no replacement is available, blow out the valve with compressed air from the outside to the inside of the tank. The oil tank must then be flushed out.



## 8.7 Oil pump

### 8.7.1 Removal

Remove chain sprocket and cover plate (3.7.1). Drain the oil tank. Unscrew the cover – four pan head screws. Take spur gear off the crankshaft. Turn spur gear with worm several times clockwise and then pull it off. Unscrew three pan head screws from pump housing and then lift off oil pump.

### 8.7.2 Disassembly of Oil Pump

Remove rubber ring from control bolt. Use a suitable pair of pliers to press the control bolt against the helical spring and far enough out of the pump housing so that the pin can be taken out.

Push the control bolt out of the pump housing. Lever the plug out of the pump housing with a screwdriver and knock the plunger out of the housing. Use a screwdriver to lever the sealing ring out of its seat. Wash pump housing and plunger in clean gasoline and blow out the ports with compressed air.

### 8.7.3 Assembly of Oil Pump

Press or drive in new sealing ring with press arbor until it locates against the housing shoulder. Lightly grease teeth of pump plunger; slide plunger into housing. Insert control bolt (slot must face plug). Insertion of the control bolt is easier if the pump plunger is pressed inwards at the same time with a screwdriver. Fit the plug.

Top:  
Unscrew cover  
Bottom:  
Pull off spur gear and unscrew spur gear with worm

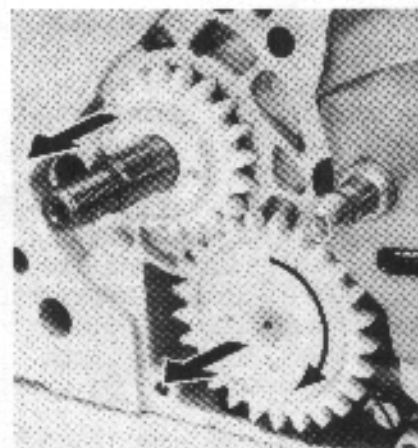
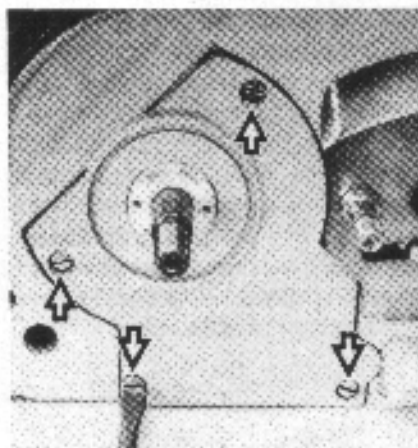

### 8.7.4 Installation of Oil Pump

Position gasket exactly on crankcase. Fit oil pump. Coat threads of pan head screws with jointing paste and then fit the screws.

**Important:** It is essential to check that the washer 0000 958 0402 is on the worm shaft before fitting the worm or the pump housing will otherwise wear rapidly.

Unscrew oil pump

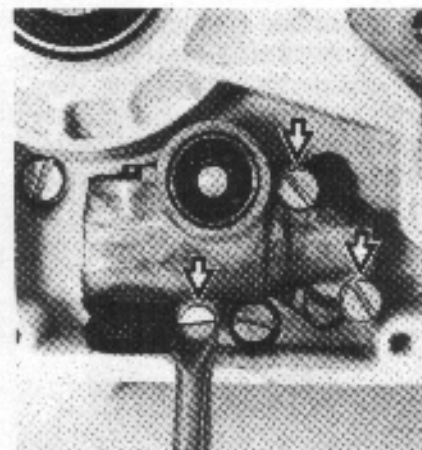

In the case of repairs to oil pumps before machine number 4 292 241 the washer 0000 958 0504 must be on the worm shaft.

Fit the spur gear with worm, push in and turn clockwise as far as it will go.

Assembly is otherwise a reversal of the disassembly procedure.

**Note:** The oil pump 1117 640 3200 installed up to machine number 4 291 241 can be replaced by oil pump 1113 640 7100 (complete with worm).

## 9. FUEL SYSTEM

### 9.1 Construction

The all position diaphragm carburetor consists of the fuel pump and the carburetor body. The fuel pump operates as a completely separate and independent unit although it shares a common housing with the carburetor.

### 9.2 Operation of Fuel Pump

The pressure in the crankcase varies with each stroke of the piston. The piston creates a depression in the crankcase on its upward stroke and overpressure on its downward stroke. This process is utilized for actuation of the fuel pump. The chamber in front of the pump diaphragm (impulse chamber) is connected to the crankcase by a hose. The changes in pressure act directly on the pump diaphragm and cause it to move in time with the piston. Control is effected via two flap valves stamped into the pump diaphragm.

The depression created by the upward stroke of the piston draws the pump diaphragm into the impulse chamber thus enlarging the pump chamber - a vacuum is produced. The inlet valve opens, the higher atmospheric pressure forces fuel from the tank into the pump chamber and presses the outlet valve onto its seat.

The downward stroke of the piston changes the relative pressures. An overpressure is built up in the crankcase and pump chamber which presses the diaphragm against the pump chamber and exerts pressure on the fuel. The overpressure forces the inlet valve to close while the outlet valve opens and allows fuel to flow to the carburetor's needle valve.

### 9.3 Operation of Carburetor

The opening and closing of the needle valve and, therefore, the supply of fuel to the carburetor is controlled by the metering diaphragm. The metering diaphragm is in a position of rest when atmospheric and diaphragm chamber pressures are equal (the chamber in front of the diaphragm is connected to atmosphere).

The cone of the inlet needle is held on its seat by spring pressure.

The metering diaphragm chamber is filled with fuel when the engine is running. A vacuum is created in the choke tube (venturi) during the induction stroke. Fuel is drawn into the choke tube through the jet bores between choke tube and diaphragm chamber. This in turn produces a vacuum in the diaphragm chamber and the atmospheric pressure of the free air presses the metering diaphragm

towards the carburetor body. The force generated by the pressure difference times diaphragm area acts on the inlet control lever via the perforated disc on the diaphragm, overcomes spring force and lifts the inlet needle off its seat. This allows fresh fuel to flow from the pump chamber into the diaphragm chamber. The needle valve closes again as soon as atmospheric pressure is reached in the metering diaphragm chamber. Under normal operating conditions the needle valve does not open and close constantly. The metering diaphragm actually settles down to a mean level depending on engine speed and the needle valve remains open relative to the diaphragm's position.

The quantity of fuel drawn into the choke tube depends on the amount of vacuum and this in turn is influenced by the position of the choke and throttle valves. The volume of fuel can be altered to suit different operating conditions by means of adjustment screws for the idle and main jets.



Top:  
Starting position

Bottom:  
Idle position

- 1 Impulse nipple
- 2 Inlet valve open
- 3 Fuel Intake
- 4 Choke valve
- 5 Valve jet
- 6 High speed adjustment screw
- 7 Pump diaphragm (intake position)
- 8 Outlet valve closed
- 9 Throttle valve

(both adjustment screws are drawn offset by 90°)

Top:  
Changing from idle to part or full-throttle position

Bottom:  
Full throttle position

- 10 Secondary idle jet
- 11 Primary idle jet
- 12 Low speed adjustment screw
- 13 Metering diaphragm chamber
- 14 Metering diaphragm
- 15 Connection to atmosphere
- 16 Inlet control lever
- 17 Inlet needle

Four basic operating conditions are described below to explain the function of the carburetor:

1. The choke valve is closed and the throttle valve partly opened during the **starting process**. A powerful vacuum is created in the choke tube during the induction stroke because the entry of outside air is almost completely restricted by the closed choke valve. This means that the engine draws in a large amount of fuel through all the jets and relatively little air. A rich starting mixture is obtained in this way. The choke valve must be opened as soon as the engine fires – the mixture would otherwise be too rich and stall the engine.

2. Very little fuel is required for **idling**. The choke valve is fully opened and the throttle valve almost completely closed. The vacuum only acts on the **primary idle jet** so that fuel is only drawn off through this jet. Owing to the pressure difference between the choke tube (venturi) and the intake pipe behind the throttle valve, supplementary air could get into the diaphragm chamber through the **main jet** (valve jet), making the mixture too lean and causing the engine to stall. This is prevented by a small plate in the valve jet which closes against the inlet when there is insufficient vacuum in the choke tube.

3. During the **changeover** from idle to part or full-throttle sufficient fuel must be drawn in with the sudden-

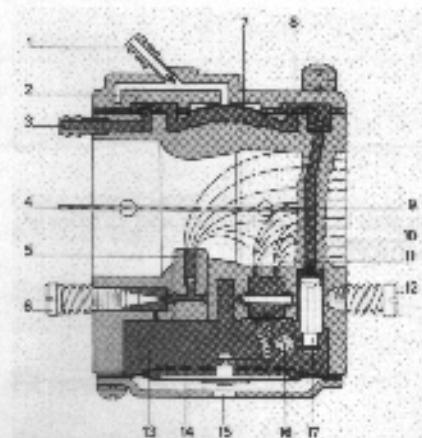
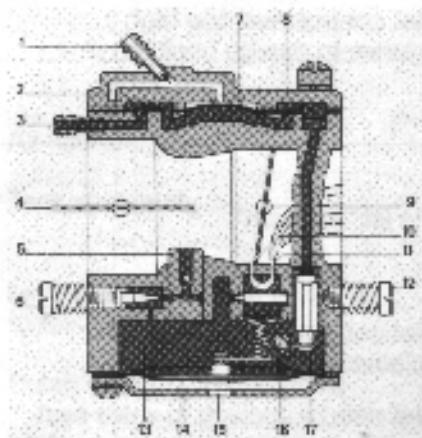
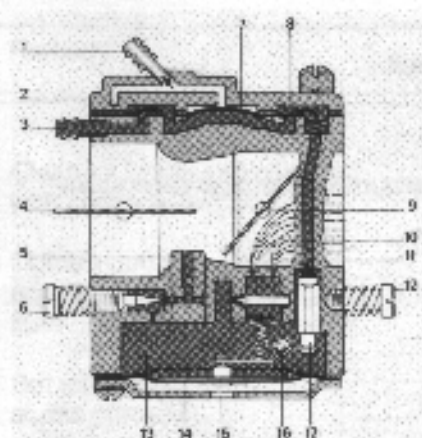
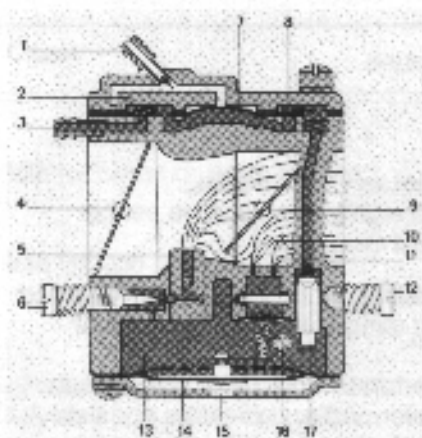

ly increased flow of air when the throttle valve is opened. This is effected by means of the secondary idle jet which is exposed to the effects of vacuum at this point, thus producing the richer, ignitable mixture required.

4. Opening the throttle valve further brings the **main jet (valve jet)**, located at the narrowest point of the choke tube (venturi), into operation and provides the fuel required for **full-throttle operation**.

## 9.4 Troubleshooting Chart

Fault	Cause	Remedy
Carburetor floods; engine stalls	Inlet valve not sealing. Foreign matter in valve seat or seat damaged	Remove inlet needle and clean or renew
	Helical spring not properly located on dimple of inlet control lever	Remove inlet control lever and refit correctly
	Perforated disc on diaphragm is deformed and presses constantly against inlet control lever	Fit new metering diaphragm
	Inlet control lever too high (relative to design position)	Set inlet control lever flush with top of plate
Engine does not respond properly to throttle	Idle jet "too lean"	Back off low speed adjustment screw slightly (see carburetor adjustment)
	Inlet control lever too low (relative to design position)	Set inlet control lever flush with top of plate
	Inlet needle sticking to valve seat	Remove inlet needle or carburetor body, clean thoroughly and refit
	Vent bore to atmosphere blocked	Clean bore
	Diaphragm gasket leaking	Fit new diaphragm gasket
Metering diaphragm damaged	Fit new metering diaphragm	
Engine will not idle	Throttle valve opened too far by idle speed adjusting screw	Readjust idle speed adjusting screw



Fault	Cause	Remedy
Engine stalls at idle speed	Idle jet bores or ports blocked	Clean jet bores and blow out with compressed air
	Idle jet "too rich"	Tighten down low speed adjustment screw slightly (see Carburetor Adjustment)
	Idle speed adjusting screw not set properly – throttle valve completely closed	Set idle speed adjusting screw correctly
Engine speed drops off quickly under load – low power	Air filter dirty	Clean air filter
	Tank vent faulty	Clean tank vent or replace if necessary
	Leak in fuel line from tank to fuel pump	Seal or renew connections and fuel line
	Pump diaphragm damaged	Fit new pump diaphragm
	Main jet bores or ports blocked	Clean bores and ports
	Fuel strainers dirty	Clean fuel strainers

## 9.5 Leakage Testing the Carburetor

Top:  
Release slotted nut on carburetor box cover  
Bottom:  
Unscrew air filter

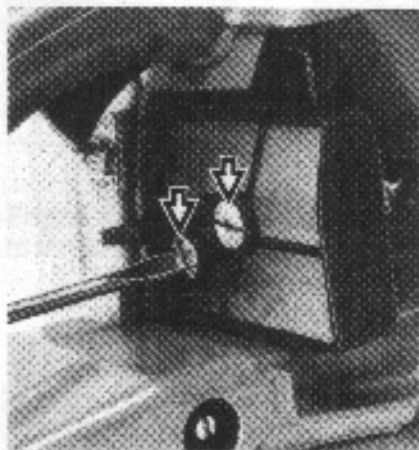
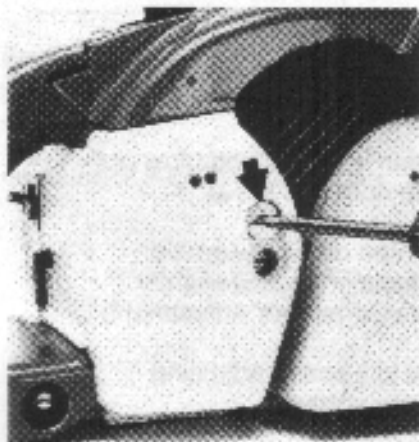

The carburetor can be tested for leaks with the carburetor and crankcase tester.

Release the slotted nut and take off the carburetor box cover. Unscrew the two slotted nuts from the air filter and take it off. Pull the fuel line off the elbow connector on the carburetor.

Use a spare fuel hose 1113141 8610 as an adapter and push one end onto the carburetor elbow connector and the other into the tester's pressure hose.

Tester connected

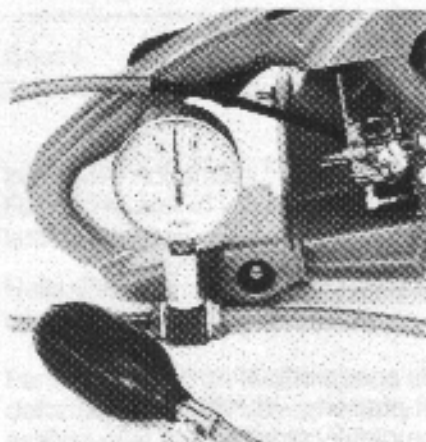

Close the vent screw on the rubber bulb and pump air into the carburetor until the pressure gauge shows a reading of 0.4 to 0.5 bar.

If this pressure remains constant, the carburetor is airtight. However, if it drops, there are two possible causes:

1. The inlet needle is not sealing (foreign matter in valve seat or cone of inlet needle is damaged).
2. The metering diaphragm is damaged.

In either of these cases the carburetor must be removed and repaired.

## 9.6 Removal of Carburetor (see chapter 3.3)

## 9.7 Repairing the Fuel Pump

Unscrew the end cover

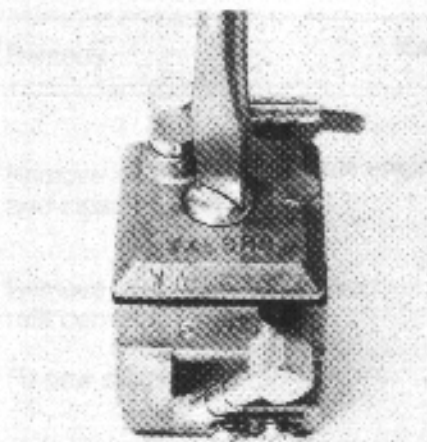

### 9.7.1 Removal

Unscrew oval head screw from pump end cover and take off the end cover.

First remove the gasket and pump diaphragm. The end cover, gasket and diaphragm are often firmly stuck together and must be carefully separated if this is the case.

### 9.7.2 Visual Inspection

If the pump diaphragm is wavy or the valve flaps show signs of severe wear, the diaphragm is no longer serviceable and must be replaced.



## 9.8 Repairing the Carburetor

Top:  
Fuel strainer  
Bottom:  
Position the end cover

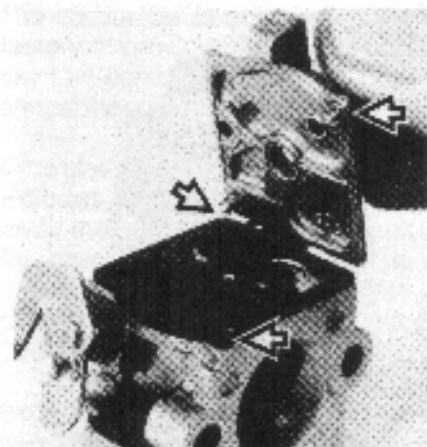
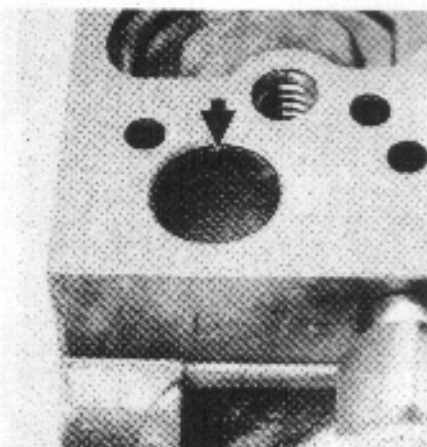

If the fuel strainer at the pump side of the carburetor body is dirty, it should be levered out with a screwdriver and washed in clean gasoline. Always replace the fuel strainer if it shows any signs of damage.

**Important:** Position gaskets correctly during reassembly.

Unscrew round head screws

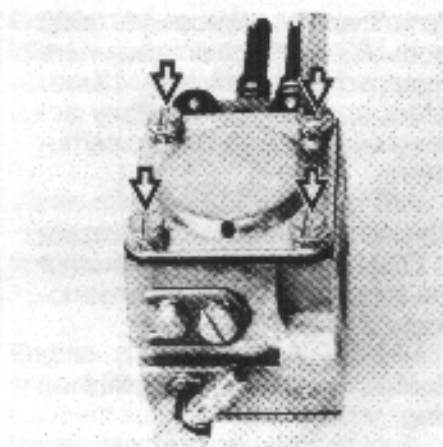

### 9.8.1 Disassembly

Unscrew the four round head screws on the metering chamber cover and take off the cover.

The end cover, gasket and diaphragm may also be stuck firmly together and must be separated very carefully if this is the case.

Take out the oval head screw and lift off the plate and gasket. Unscrew the round head screw, remove the inlet control lever with spindle and spring. Turn the carburetor over so that the inlet needle drops out. If an annular indentation is visible on the cone of the inlet needle, it should be replaced as it will no longer seal properly. This is indicated by constant flooding of the carburetor even after cleaning the needle.

Wash out the carburetor body and all parts which can be used again in clean gasoline (never use high octane gasoline) and blow out with compressed air, particularly the

Unscrew countersunk and round head screws

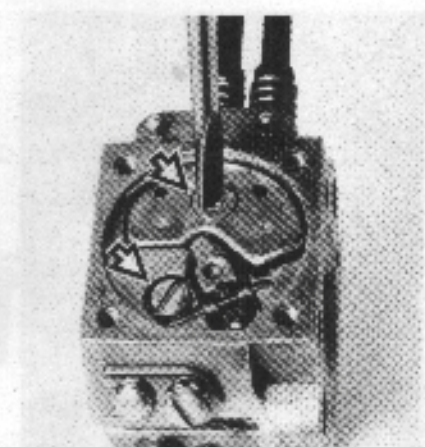

bores and ports, but first remove the two adjustment screws for this purpose.

### 9.8.2 Reassembly

Fit the inlet needle and helical spring in their respective bores. Insert spindle in inlet control lever and engage short clevis in the annular groove at the top of the inlet needle. Tighten down the oval head screw while making sure the helical spring locates on the control lever's nipple. Check freedom of movement of inlet control lever. Secure plate and gasket with oval head screw. Place gasket, metering diaphragm and end cover on the carburetor body and secure.

## 9.9 Repairing the Carburetor - 031 (030)

Top:  
Inlet control lever correctly positioned  
Bottom:  
Fitting metering diaphragm

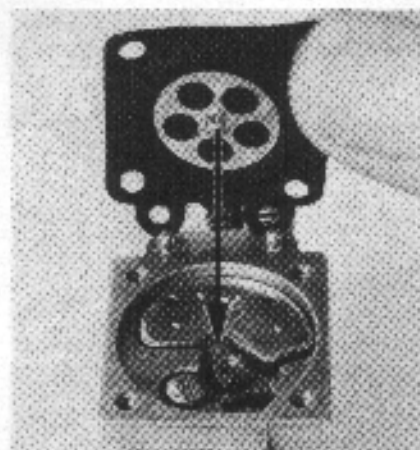
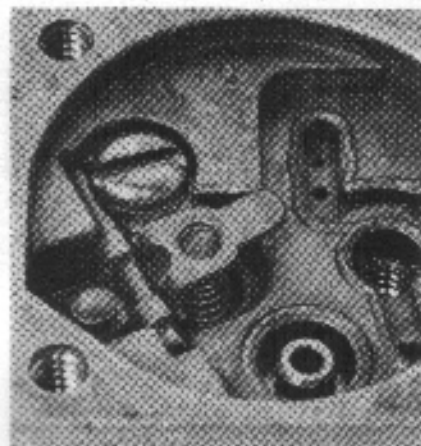

The hole in the end cover must point away from the adjustment screws.

Up to machine number 4970520 model 031 (030) chain saws were equipped with Tillotson carburetors (except 031 AV). They are now equipped with Walbro carburetors.

Chapters 9.8.1 and 9.8.2 still apply to Tillotson carburetors because of the substantially similar constructions.

**Exception:** Main jet and blanking plug.

If the small plastic plate in the valve jet (main jet) is stuck, press out the jet from the diaphragm chamber side toward the choke tube with a suitable tool (5mm diameter punch).

When installing the valve jet make sure it is inserted exactly vertically and not canted in the bore. The rear edge of the valve jet must be flush with the bottom of the diaphragm chamber.

Check the blanking plug for leaks by coating it with oil and applying a compressed air line to the tapped hole for the idle speed adjustment screw. If air bubbles appear in the oil, carefully peen the circumference of the blanking plug and check again. Fit a new blanking plug if the leaks persist.

To remove the old plug, apply a punch of about 3mm diameter to the center of the plug. Press or tap the punch until the plug buckles downward and is released from the wall of the hole. Take out the plug and blow through the idle hole with

Top:  
Main jet and blanking plug  
Bottom:  
Press in blanking plug

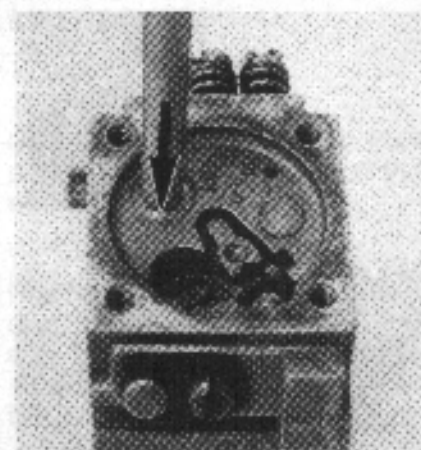
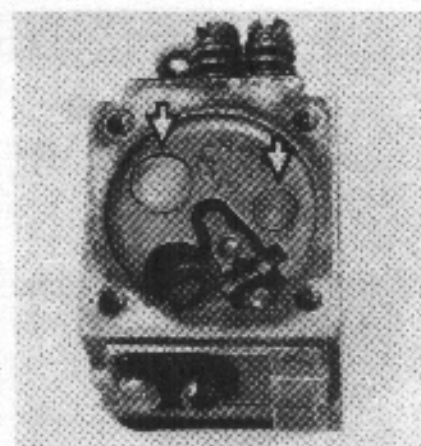

compressed air.

Fit the new blanking plug in the hole with the curvature facing upwards and then press it flat with a punch about 6mm diameter.



## 9.10 Adjusting the Carburetor

## 9.10.1 Fine Adjustment of Carburetor

## 9.11 Adjusting the carburetor - 031 (030)

See chapters 9.10 and 9.10.1

- 1 High speed adjustment screw  
2 Low speed adjustment screw  
3 Idle speed screw

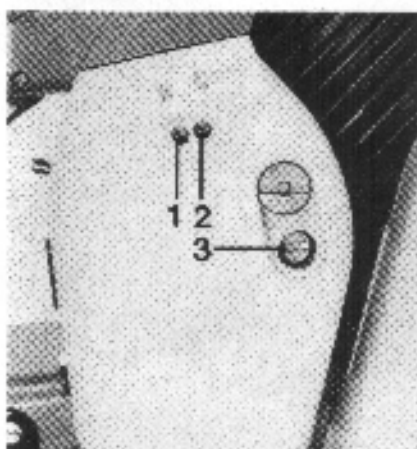

The carburetor is adjusted at the factory to provide high power and low fuel consumption under local atmospheric conditions.

If the chain saw is operated at high altitudes (mountains) or near sea level, the carburetor setting must be changed. This correction is made at the two adjustment screws and the idle speed screw.

Both adjustment screws must be very carefully screwed down onto their seats in order to obtain the basic setting which is used as the starting point for fine adjustment. Then adjust as follows:

**High speed adjustment screw H:**  
Open  $1\frac{1}{2}$  turns

**Low speed adjustment screw L:**  
Open  $1\frac{1}{2}$  turns

**Engine stops while idling:** Turn idle speed screw slightly clockwise while the engine is running (chain must not rotate)

**Chain rotates at idle speed:** Turn idle speed screw slightly counterclockwise.

**Engine runs erratically at idle speed:** Regulate at low speed adjustment screw. Turn clockwise for leaner mixture or counterclockwise for richer mixture.

**Important:** Only very slight alteration of the adjustment screw settings has a marked effect on engine running characteristics.

The adjustment screws must not be interchanged.

Always carry out carburetor adjustments with the engine warm and the air filter clean.

- 1 High speed adjustment screw  
2 Low speed adjustment screw  
3 Idle speed screw

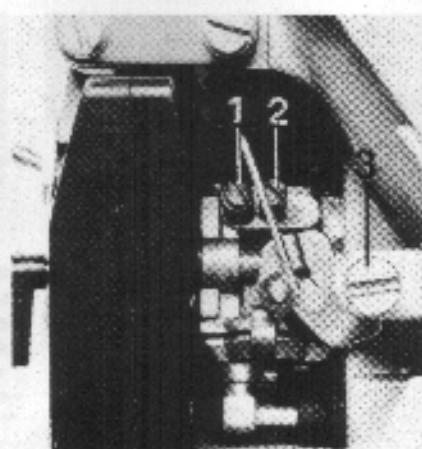

**Exception: High speed adjustment screw H:** Open  $1\frac{1}{4}$  turns

**Low speed adjustment screw L:**  
Open  $1\frac{1}{4}$  turns.

## 9.12 Fuel Line and Tank Vent

Tank vent in filler cap



### 9.12.1 Operation

The diaphragm pump draws fuel out of the tank and into the carburetor via the fuel line. Any impurities mixed with the fuel in the tank are filtered out by the pickup body (filter and strainer). The wire mesh in the pickup body and the fine pores of the filter eventually become clogged with minute particles of dirt. This restricts passage of fuel and the result is fuel starvation.

Correct operation of the carburetor depends on fuel tank and atmospheric pressures always being equal. This is assured by the tank vent in the fuel filler cap.

Withdrawing the pickup body



### 9.12.2 Cleaning the Pickup Body

In the event of trouble with the fuel supply system, always clean the pickup body first. To do this, pull the pickup body out through the tank filler and disconnect it from the hose. Take off the cap and then remove and clean the filter, strainer and insert. Do not damage the wire mesh in the pickup body.

It is not advisable to clean the filter — always fit a new one. Take this opportunity to clean the fuel tank by flushing it out with clean gasoline and then reverse the above procedure to assemble all the parts.

In the event of difficulties with the carburetor or fuel supply, always check and clean the tank vent.

Lever out elbow connector



### 9.12.3 Removal and Installation of Hose

Remove handle frame (5.3). Lever out elbow connector with a screwdriver. Pull fuel hose and pickup body out of the tank filler opening.

When installing the hose make sure the recess on the bead locates against the housing shoulder.

Lubricate elbow connector with a little grease before fitting it and then press it into the fuel line in the correct position.



## 10. AIR FILTER AND CHOKE VALVE

Top:  
Air filter  
Bottom:  
Remove carburetor box cover on 032

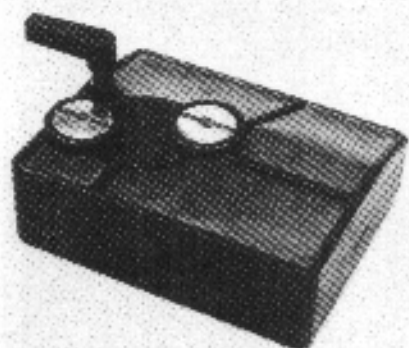

Top:  
Remove carburetor box cover on 031  
Bottom:  
Remove slotted nuts

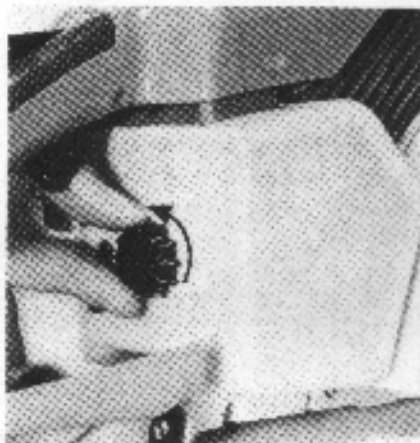

Prise two halves of filter apart

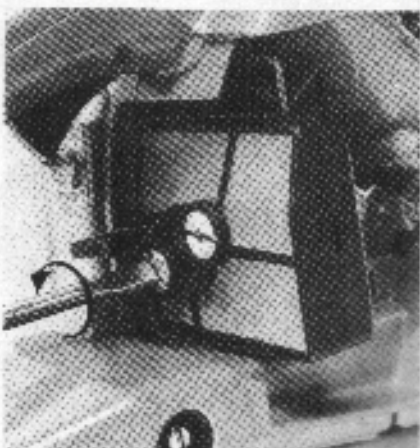
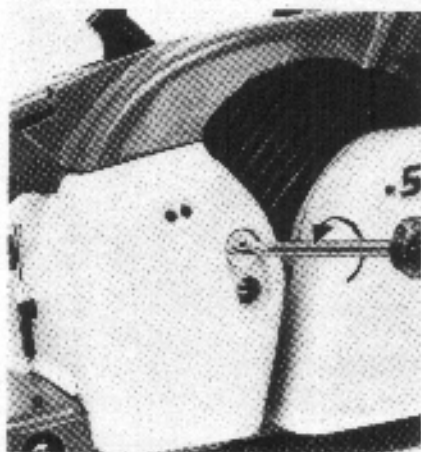
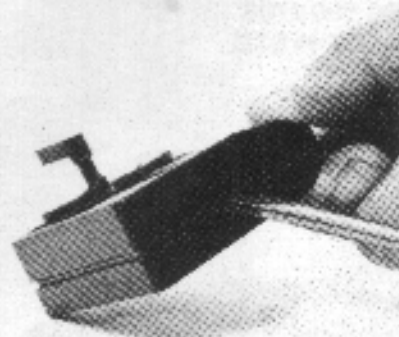

in clean gasoline and blowing out with compressed air.

**Note:** If the wire mesh is damaged in any way, fit a new element – the engine can be permanently damaged by dirt drawn in with the intake air.

### 10.1 Operation

The air filter's function is to intercept dust and dirt in the intake air and thus reduce wear on engine components.

Clogged air filters have a detrimental effect on engine performance, they increase fuel consumption and make starting more difficult.

### 10.2 Removing and Cleaning the Filter

Remove the carburetor box cover. Clean dirt off filter and area surrounding it before removing. Unscrew the two slotted nuts in the filter and lift the complete unit off the studs. Prise the two halves of the filter apart with a screwdriver; a slot is provided in the rear half of the filter for this purpose. Clean the two halves of the filter by washing them

**Special tool kits  
and testing tool kit**

**Special tool kit (small)  
0000 890 1706  
(for 009 to 032)**

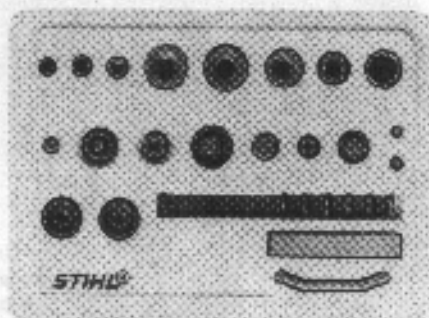

**Special tool kit (large)  
0000 890 1705**

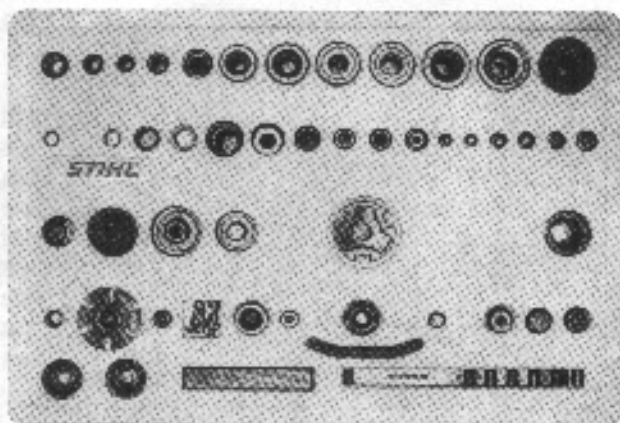

**Testing tool kit 0000 890 1710**

