

STIHL 028, 038

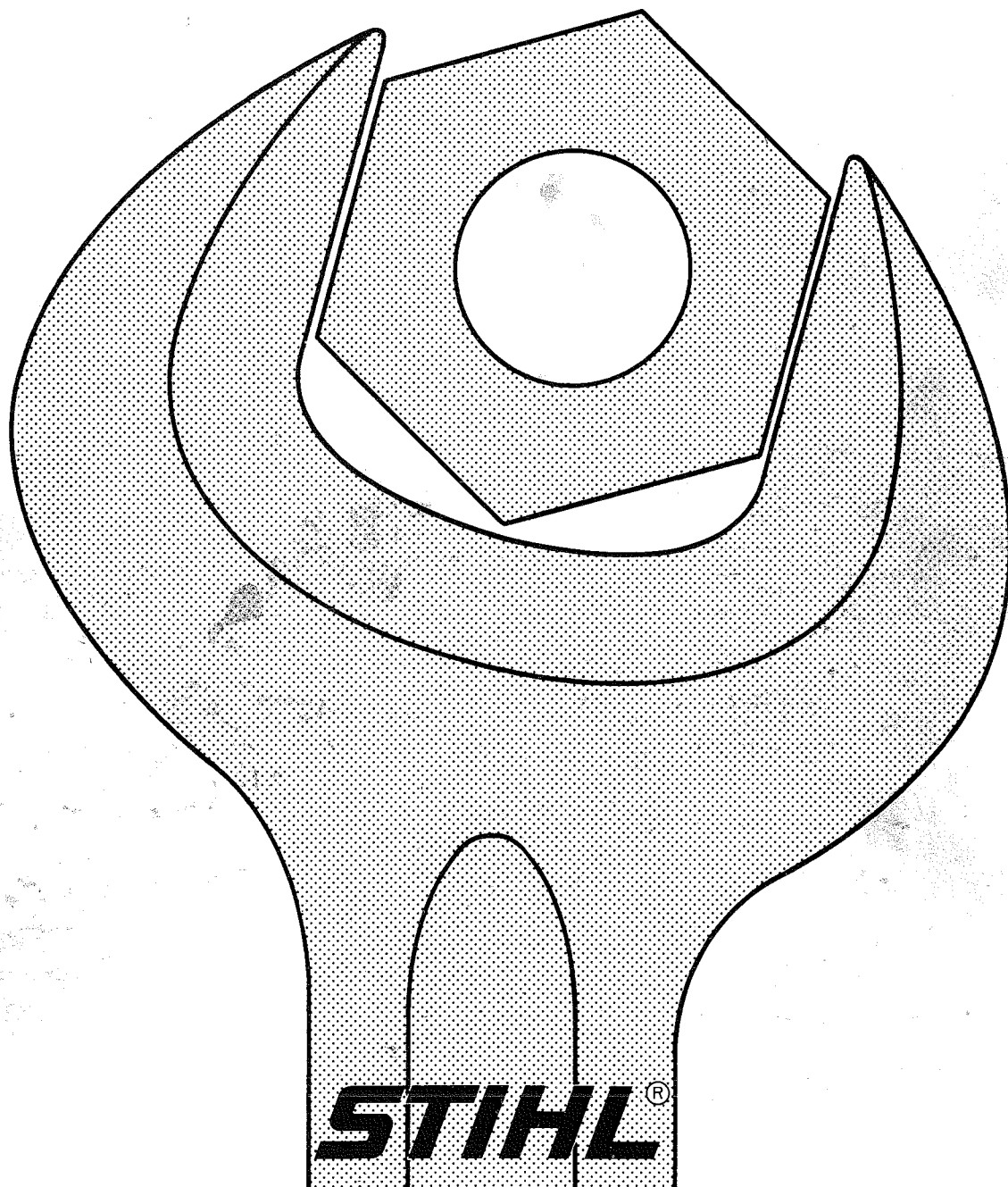

SERVICE MANUAL 028/038

FOREWORD

This Service Manual covers model 028 chain saws up to machine number 5561640 as well as later machines unless technical information bulletins have been issued in the meantime with updated repair procedures.

Models 038 have substantially the same constructional features as model 028 chain saws. This Service Manual can therefore be used for the 038 chain saws as well.

In the event of faults it is quite possible that a **single malfunction may have several causes**. It is, therefore, advisable to consult the "troubleshooting charts" when tracing faults. We also recommend that you make use of the exploded views in the illustrated parts lists while carrying out repair work.

This service manual and all technical information bulletins are intended exclusively for the use of STIHL servicing staff and dealers and must not be passed on to third parties.

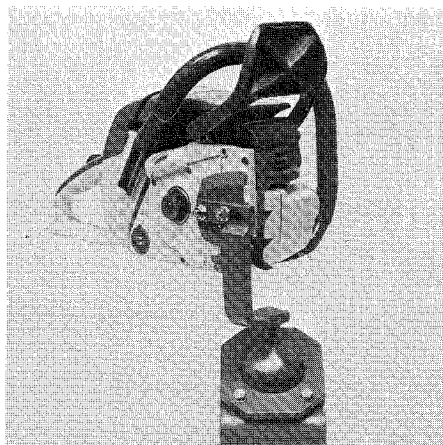

Repair work is made considerably easier if the chain saw is mounted on assembly stand 5910 8503100. The saw is easily attached to the stand by means of the two stud bolts and collar nuts for bar mounting.

While on the assembly stand, the chain saw can be swivelled into any required position to suit the repair in question. This not only has the advantage of keeping the component in the best position for the repair, but also leaves both hands free for the work, and thus represents a considerable time-saving.

SPECIAL TOOL MANUAL

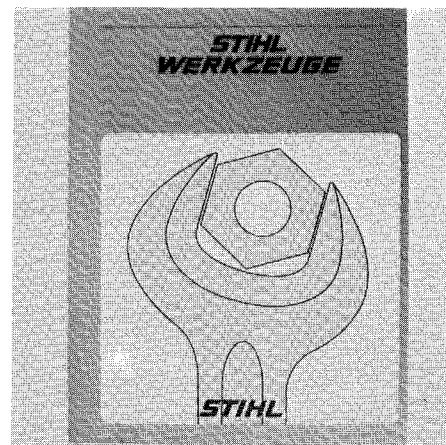

Our special tool manual illustrates and lists the part numbers of all available machine-related tools as well as general purpose tools for all machines.

The special tool manual is available in various languages and can be ordered by quoting the appropriate part number listed hereunder.

German	0455 901 0023
English	0455 901 0123
French	0455 901 0223
Spanish	0455 901 0323
Yugoslav	0455 901 0423
Swedish	0455 901 0523
Italian	0455 901 0723
Portuguese	0455 901 1223

STIHL® Andreas Stihl
Postfach 1760
D-7050 Waiblingen

CONTENTS

1.	Specifications	4	4.	Ignition System	26	4.5.1	Checking on breaker-controlled ignition	45
2.	Clutch, Chain Drive and Chain Brake	7	4.1	Construction	26	4.5.2	Adjustment on breaker-controlled ignition	45
2.1	Construction and operation	7	4.2	Operation	26	4.5.3	Checking on electronic ignition	47
2.1.1	Clutch and chain sprocket	7	4.2.1	General information	26	4.6	Magneto edge gap	48
2.1.2	Chain brake	8	4.2.2	Breaker-controlled magneto ignition	27	5.	Rewind Starter	49
2.2	Troubleshooting chart	8	4.2.3	Bosch transistor-controlled magneto ignition	28	5.1	Construction and operation	49
2.3	Disassembly and repair	9	4.2.4	SEM thyristor-controlled magneto ignition	29	5.2	Troubleshooting chart	49
2.3.1	Clutch	9	4.2.4.1	Charging the storage capacitor	29	5.3	Disassembly	50
2.3.2	Chain brake	12	4.2.4.2	Triggering the thyristor	29	5.4	Replacing the starter rope	50
2.4	Assembly	13	4.2.4.3	Ignition	30	5.5	Replacing the rewind spring	51
2.4.1	Chain brake	13	4.3	Troubleshooting chart	31	5.6	Tensioning the rewind spring	51
2.4.2	Clutch	14	4.3.1	Breaker-controlled ignition system	31	5.7	Replacing starter rope guide bush	52
3.	Engine	15	4.3.2	Electronic ignition system	32	5.8	Routine maintenance	52
3.1	Construction	15	4.4	Function and repair of components	33	6.	AV Handle System	53
3.2	Troubleshooting chart	15	4.4.1	Spark plug	33	6.1	Construction and operation	53
3.3	Exposing the cylinder	16	4.4.2	Ignition lead	34	6.2	Repair	53
3.4	Disassembly of cylinder and piston	16	4.4.3	Short-circuit wire/ground wire	35	7.	Master Control	55
3.5	Assembly of piston and cylinder	17	4.4.4	Short-circuit contact	36	7.1	Construction and operation	55
3.6	Disassembly of crankcase - removal of crankshaft	19	4.4.5	Flywheel	37	7.2	Disassembly and assembly	55
3.7	Installing the Crankshaft - assembly of crankcase	21	4.4.6	Armature (Bosch)/ignition module (SEM)	39			
3.8	Leakage testing the crankcase	23	4.4.6.1	Resistance test on primary winding	39			
3.8.1	Pressure test	23	4.4.6.2	Resistance test on secondary winding	39			
3.8.2	Vacuum test	25	4.4.6.3	Ignition coil tester	40			
3.8.3	Replacing the oil seals	25	4.4.6.4	Disassembly and assembly	40			
			4.4.7	Condenser	41			
			4.4.8	Contact set	42			
			4.4.9	Trigger plate	44			
			4.5	Ignition timing	44			

8.	Electric Handle Heating System	56	10.7	Fuel line and tank vent	71
8.1	Construction and operation	56	10.8	Air filter and choke	72
8.2	Troubleshooting	56			
8.3	Disassembly and assembly	58			
8.3.1	Switch	58			
8.3.2	Heating element in pistol grip	58			
8.3.3	Handlebar	58			
8.3.4	Generator	59			
9.	Chain Lubrication	60			
9.1	Construction and operation of oil pump	60			
9.2	Troubleshooting chart	61			
9.3	Oil tank/tank vent	62			
9.4	Repair of pickup body and valve	62			
9.5	Disassembly and repair of oil pump	63			
10.	Fuel System	64			
10.1	Construction and operation of carburetor	64			
10.1.1	Operation of fuel pump	64			
10.1.2	Operation of carburetor	64			
10.2	Troubleshooting chart	66			
10.3	Leakage test on carburetor	68			
10.4	Disassembly of carburetor	68			
10.5	Repair of carburetor	69			
10.6	Carburetor adjustment	71			
10.6.1	Notes for fine adjustment of carburetor	71			

1. SPECIFICATIONS

1.1 Engine

	STIHL single cylinder, two-stroke engine with special impregnated cylinder bore
Displacement:	47 cm ³ (2.87 cu. in)
Bore:	44 mm (1.73 in)
Stroke:	31 mm (1.22 in)
Compression ratio:	9.5:1
Max. torque:	2.65 Nm (1.95 lbf. ft) at 6000 rpm
Max. permissible engine speed:	12000 rpm
Mean idle speed:	2200 rpm
Crankshaft:	Two-part, drop-forged
Crankshaft bearings:	2 deep-groove ball bearings
Crankpin:	14.4 mm (0.57 in) dia.
Big-end bearing:	Needle cage
Piston pin:	10.0 mm (0.39 in) dia.
Small-end bearing:	Needle cage
Rewind starter:	Pawl engagement with automatic starter rope rewind mechanism
Starter rope:	3.5 mm (0.14 in) dia., 1060 mm (41.8 in) long
Clutch:	Centrifugal clutch without linings, 76 mm (3 in) dia.
Clutch engages at:	Approx. 3100 rpm
Crankcase leakage test: with overpressure:	$p_{\bar{u}} = 0.5 \text{ bar (7.1 lbf/in}^2\text{)}$
with vacuum:	$p_{\bar{u}} = 0.5 \text{ bar (7.1 lbf/in}^2\text{)}$

1.2 Fuel System

Carburetor:	All-position diaphragm carburetor with integral fuel pump
Adjustment:	
high-speed adjustment screw H:	Open approx. 1/4 turns
low-speed adjustment screw L:	Open approx. 1/4 turns (basic setting with screws initially hard against their seats)
Carburetor leakage test with overpressure:	$p_{\bar{u}} = 0.4 \text{ bar (5.7 lbf/in}^2\text{)}$
Fuel capacity:	0.52 L (1.1 U.S.pt)

Fuel mixture:	Fuel mix 1:40 with STIHL two-cycle engine oil; 1:25 for other branded two-cycle engine oils
Air filter:	Flat wire mesh filter

1.3 Ignition System

028 AV and 028 AVQ

Type:	Breaker-controlled magneto ignition system
Magneto edge gap:	4 ... 8 mm (0.16 ... 0.31 in)
Air gap:	0.2 ... 0.3 mm (0.008 ... 0.012 in)
Ignition timing:	2.2 ... 2.3 mm (0.087 ... 0.091 in) before T.D.C.
Ignition advance angle:	27 ... 28°
Breaker point gap:	0.35 ... 0.4 mm (0.014 ... 0.016 in)
Condenser:	Capacitance 0.15 ... 0.19 μ F
Armature:	Coil resistors
	Primary Secondary
	0.7 ... 1.0 Ω 7.7 ... 10.3 k Ω

028 AVE

Type:	Transistor-controlled (breaker- less) magneto ignition system
Air gap:	0.2 ... 0.3 mm (0.008 ... 0.012 in)
Ignition timing:	2.6 mm (0.1 in) before T.D.C. at 8000 rpm
Ignition advance angle:	30° at 8000 rpm
Armature:	as 028 AV/028 AVQ

028 AVEQ

Type:	Thyristor-controlled (breaker- less) magneto ignition system
Air gap:	0.2 ... 0.3 mm (0.008 ... 0.012 in)
Ignition timing:	2.6 mm (0.1 in) before T.D.C. at 8000 rpm

All Models

Spark plug (suppressed):	Bosch WSR 6 F or Champion RCJ 6 Y Heat range: 200
Spark plug thread:	Electrode gap: 0.5 mm (0.02 in) M 14 x 1.25; 9.5 mm (0.37 in) long

1.4 Tightening Torques

Crankshaft nut (ignition side) M 8 x 1:	30 Nm (22 lbf. ft)
Hub/spider (output side):	50 Nm (37 lbf. ft)
M 5 socket head screws:	8 Nm (6 lbf. ft)
M 5 cheese-head screws:	5 Nm (3.7 lbf. ft)
M 4 cheese-head screws:	2.5 Nm (1.8 lbf. ft)
M 5 nuts:	5 Nm (3.7 lbf. ft)
Spark plug:	25 Nm (18.4 lbf. ft)

Important: The M 5 x 12 screws on the front handguard and the M 4 x 8 screws on the spider are fitted with LOCTITE.

1.5 Cutting Attachment

Guide bars:	STIHL Duromatic guide bars with stellite-tipped bar nose; STIHL Rollomatic guide bars with sprocket nose. Both types with corrosion resistant finish and induction hardened track
Bar lengths:	Duromatic 40 and 45 cm (16 and 18 in) Rollomatic 32, 37, 40 and 45 cm (13, 14.6, 16 and 18 in)
Chain:	0.325" (8.25 mm) pitch
Chain sprocket:	7-tooth for 0.325" chain
Chain speed:	16.4 m/s (53.8 ft/sec) at 8500 rpm
Chain lubrication:	Speed-controlled oil pump with lift plunger, operative only when chain is running
Oil delivery rate:	8 cm ³ /min (0.49 cu. in/min) at 6000 rpm
Oil tank capacity:	0.3 L (0.63 U.S.pt)

1.6 Weights

Model:	AV/AVE	AVQ/AVEQ
Dry weight with 32 cm bar and chain:	6.5 kg (14.3 lb)	6.6 kg (14.5 lb)

1.7 Special Accessories

STIHL rescue kit 028	1118 900 5000
Gasket set 028	1118 007 1050

2. CLUTCH, CHAIN DRIVE AND CHAIN BRAKE

2.1 Construction and Operation

2.1.1 Clutch and Chain Sprocket

The transmission of power from the engine to the saw chain is effected via a centrifugal clutch. On "Quick-stop" models, the centrifugal clutch incorporates an isolating clutch which is actuated by the chain brake.

On the **Quickstop version** the hub screwed to the crankshaft is the clutch element which absorbs the torque and acceleration of the crankshaft. It is essential that the hub is always tightened down to the specified torque. The clutch spider is supported on the hub by a needle sleeve and located axially with a circlip. The driving plate is located on the three lugs of the clutch spider and can move axially while remaining in constant mesh with the spider. The flat spring between the spider and driving plate presses the driving plate against the release plate; this means that the internal teeth of the driving plate are always in mesh with the teeth of the hub when the chain brake is released, and thus provides positive transmission of engine torque to the clutch spider. When the chain brake is actuated, the release plate disengages the driving plate from the hub. The clutch spider and hub can then rotate independently.

On the **standard version** the clutch spider assumes the function of the hub and must therefore always be tightened to the specified torque.

Chain brake engaged

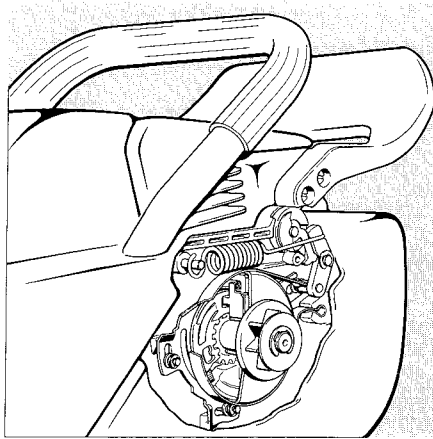

The centrifugal clutch has three clutch shoes without linings. The clutch drum and chain sprocket are separate components. The spur gear which drives the oil pump is a ring-gear, positively mounted to the hub of the clutch drum. The chain sprocket has two integrally cast lugs which engage in corresponding recesses on the drum hub. As the lugs have odd sizes, the chain sprocket can only be fitted in one position.

When the engine is running at idle speed the clutch shoes are also in the idle position, because the tension of the clutch spring is greater than the centrifugal force. As engine speed increases, centrifugal force presses the clutch shoes outwards against the clutch drum and thus transmit engine torque positively via the chain sprocket to the saw chain.

The preload and strength of the clutch spring are designed so that

Chain brake released

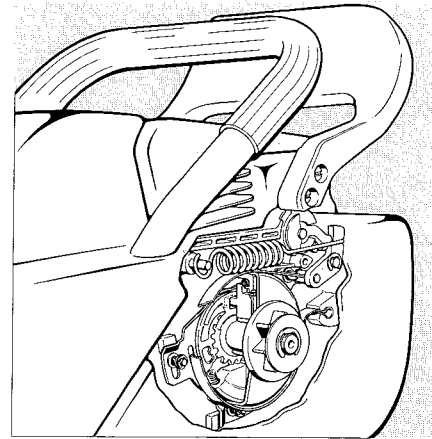

the clutch shoes begin to make contact with the clutch drum at an engine speed of approx. 3100 rpm (engagement speed). The clutch engages fully above this speed. The correct idle setting on the carburetor is therefore essential in order to insure that the clutch engagement speed is not reached when the engine is idling.

2.1.2 Chain Brake

The chain brake is a spring-loaded band brake without linings. Its main components are the brake band, tension spring, handguard and release plate – which operates the isolating clutch.

The chain brake is actuated by means of the handguard which can be used to release and engage the brake.

The **chain brake is released (reset)** by pulling the handguard back against the handlebar. This movement is transmitted via a lever system which preloads the tension spring and disengages the brake band. At the same time the release plate moves back and allows the driving plate to engage in the teeth of the hub. The brake lever, which is connected to the tension spring, brake band and release plate, is locked in the idle position by the relay lever.

The **chain brake is actuated** by moving the handguard towards the bar nose. This movement unlatches the brake lever and causes the brake band to be clamped around the clutch drum by the force of the preloaded brake spring. The release plate simultaneously disengages the driving plate from the hub and interrupts the flow of power between the crankshaft and the centrifugal clutch. Clutch drum and saw chain are brought to a standstill within a fraction of a second even if the engine continues running at high speed.

2.2 Troubleshooting Chart

Fault	Cause	Remedy
Saw chain turns at idle speed	Engine idle speed too high	Readjust at idle speed adjustment screw
	Clutch spring stretched or fatigued, spring hooks broken	Renew clutch spring
Excessive chain sprocket wear	Incorrect chain tension	Tension saw chain properly
Chain stops in mid-cut even with engine at maximum speed – Isolating clutch disengages during cutting	Isolating clutch worn	Renew hub and driving plate
	Flat spring broken	Renew flat spring
Isolating clutch does not re-engage after releasing chain brake	Engine idle speed too high	Readjust at idle speed adjustment screw
	Flat spring broken	Renew flat spring
Saw chain does not stop immediately when chain brake is engaged	Tension spring broken	Renew tension spring

2.3 Disassembly and Repair

2.3.1 Clutch

Top:
Chain brake released

Bottom:
Pressing out the retaining washer

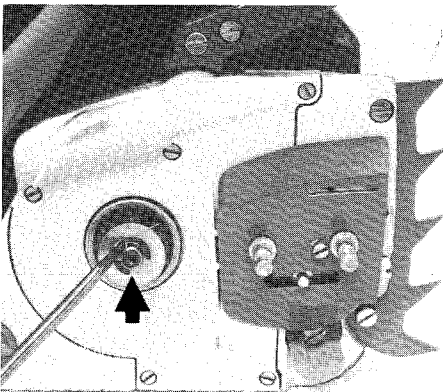
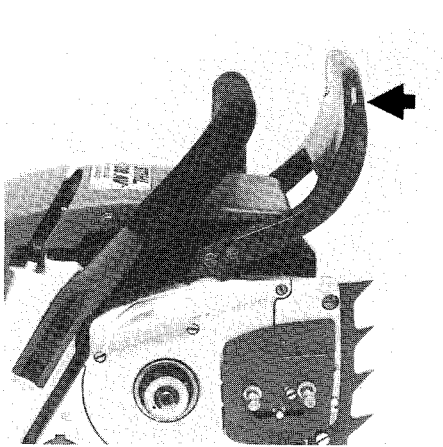

First remove chain sprocket cover and cutting attachment.

The chain brake must be released before removing the chain sprocket. Use a screwdriver, about 5 mm wide, to press the retaining washer out of the annular groove in the crankshaft. The thrust washer, chain sprocket and needle sleeve can now be pulled off the crankshaft.

Top:
Removing the side plate

Center:
Releasing the cover

Bottom:
Ring-gear removed

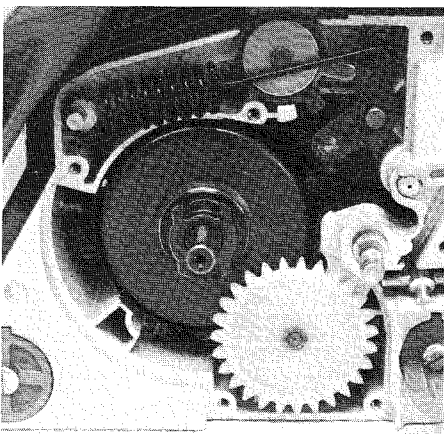
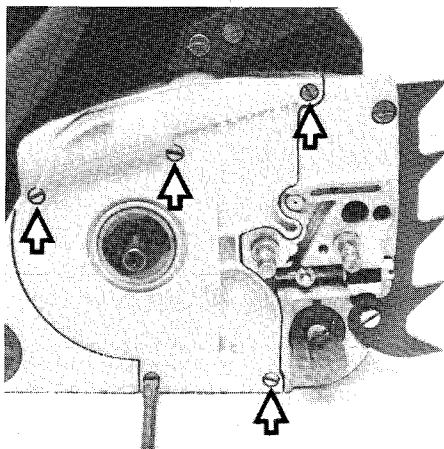
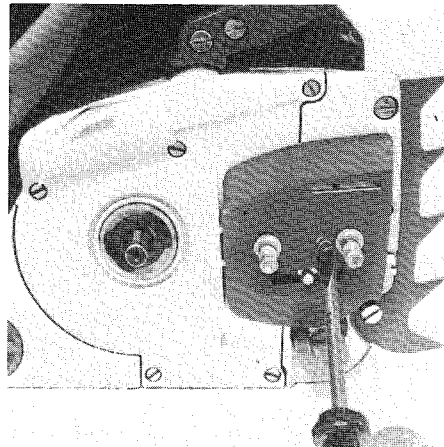

Top:
Removing the spur gear

Bottom:
Clutch drum and needle sleeve removed

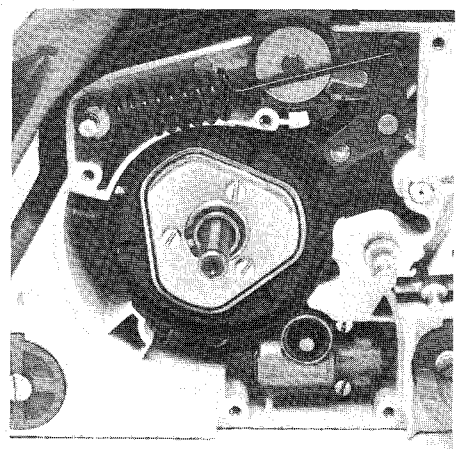
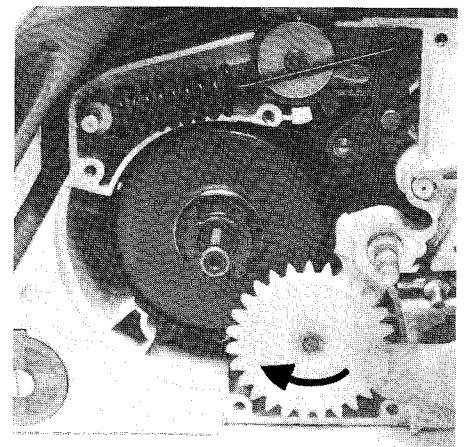

Remove the inner side plate – secured with a single M 4 x 12 cheese-head screw. Unscrew the five M 4 x 12 cheese-head screws and take off the cover. Now remove ring gear from clutch drum hub and the spur gear (with worm) from the oil pump shaft by turning it clockwise. Pull clutch drum and needle sleeve off the crankshaft.

Top:
Removing the circlip

Bottom:
Clutch, flat spring and needle sleeve removed

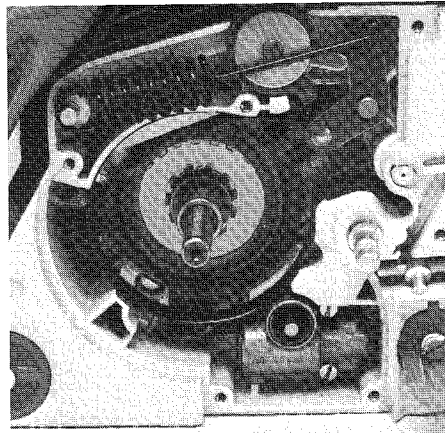
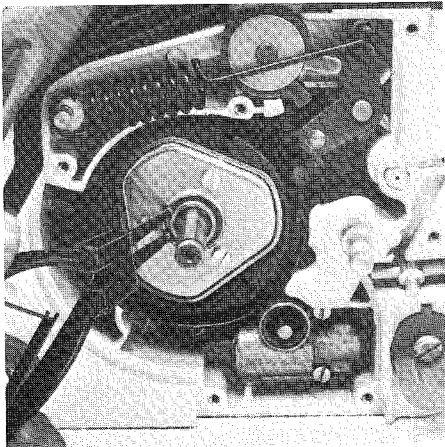

Top:
Driving plate removed

Center:
Locking screw 1107 191 1200

Bottom:
Locking screw inserted

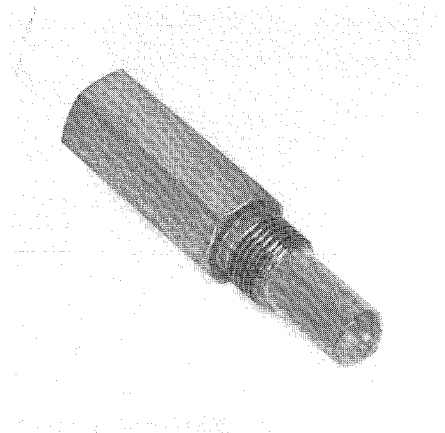
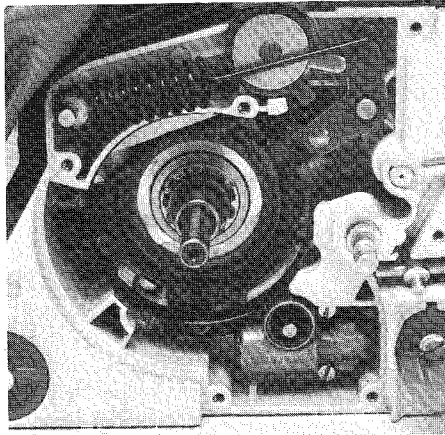

Top:
Special socket 1118 893 1300

Bottom:
Unscrewing the hub

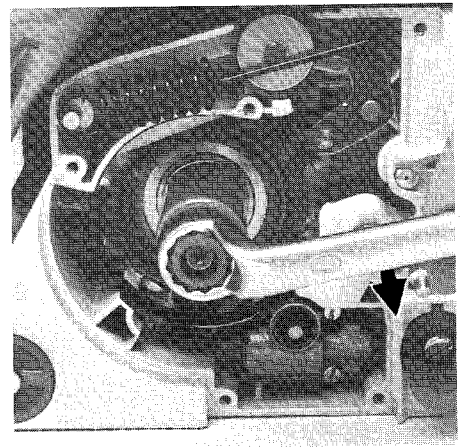
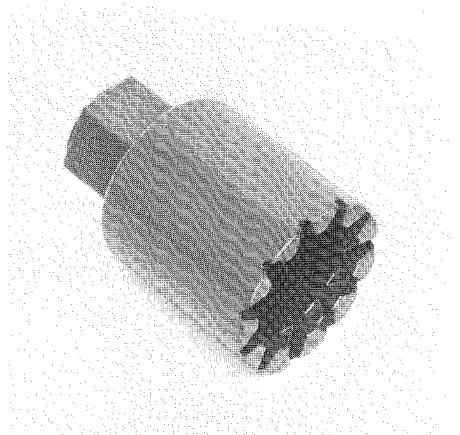

Disassembly differs on the Quickstop and standard versions from this stage onwards.

On the **Quickstop version**, first remove the circlip which locates the clutch spider on the hub. The clutch with flat spring and needle sleeve can now be pulled off the hub. If the hub has to be removed, first remove the driving plate and block the crankshaft. To do this, unscrew

spark plug and fit locking screw 1107 191 1200 in the spark plug hole and tighten down by hand. Use special socket 1118 893 1300 to unscrew the hub. Remove washer from behind hub.

Unscrewing the clutch spider

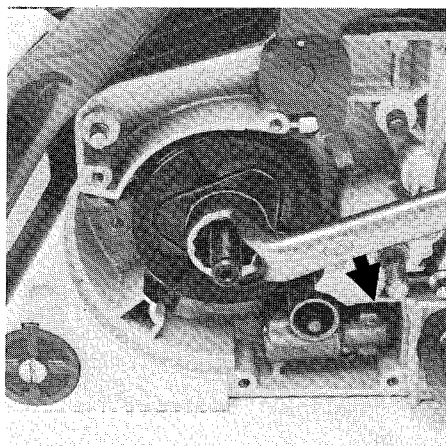

The crankshaft must also be blocked with locking screw 1107 191 1200 in order to remove the clutch spider on the **standard version**. Use a 19 mm cranked ring wrench to unscrew the clutch spider and then remove the dished cover plate.

Caution: The hub and clutch spider have left-hand threads – unscrew them clockwise.

Wash all parts of the clutch, including the needle cages, in clean gasoline and blow out with compressed air if available. Also clean crankshaft stub.

Always replace damaged or worn parts.

Top:
Removing cover plate

Bottom:
Clutch spring in spring recess

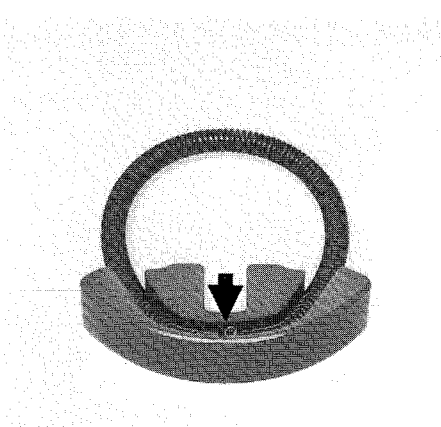
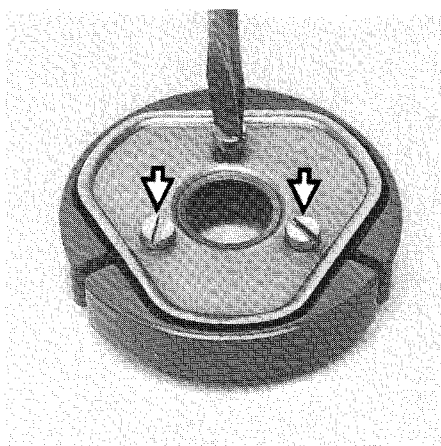

Use the following procedure to replace the clutch spring, clutch shoes or spider:

First unscrew the cover plate from the spider (Quickstop only) and then remove the clutch shoes.

To assemble the clutch, first position the clutch spring in the spring recess of one clutch shoe, so that the spring

Pressing clutch spring into position

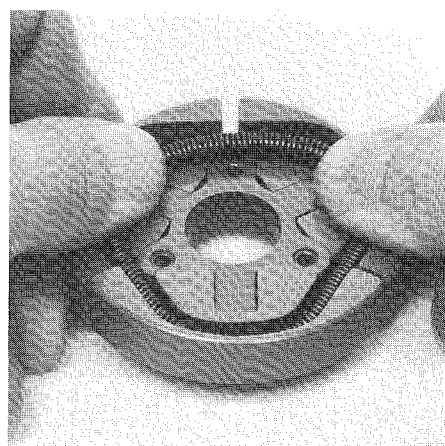

hooks are in the center of the clutch shoe. Now fit the three clutch shoes on the arms of the spider so that the spring recesses face away from the triangular plate on the spider. Grip the clutch spring with both thumbs and push it into the spring recesses of the other two clutch shoes.

Refit the cover plate on the Quickstop clutch. The three M 4 x 8 cheese-head screws must be secured with LOCTITE.

2.3.2 Chain Brake

Detaching the tension spring

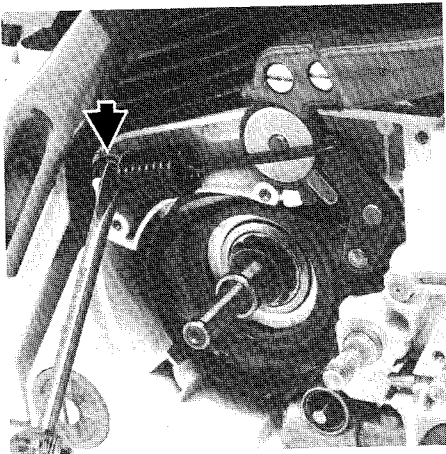

The clutch drum must be removed before the brake band can be disassembled. To do this, engage the chain brake and detach the tension spring. Remove retaining washer from brake lever's pivot pin and carefully withdraw the brake lever. Collect the washers and helical spring on the brake band's pivot pin. The other end of the brake band can now be prised out of its seat in the crankcase.

Take out the clutch before removing the release plate. Remove the retaining washers, washers and helical springs from the guide pins and take the release plate out of the crankcase.

Unscrew the handguard (the cheese-head screws will be difficult to remove because they are fitted with LOCTITE) and then take out the actuating lever, relay lever and torsion spring.

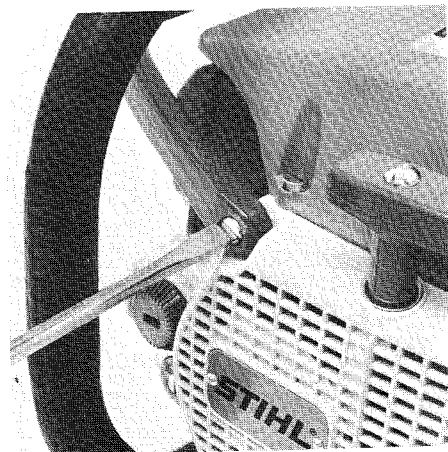
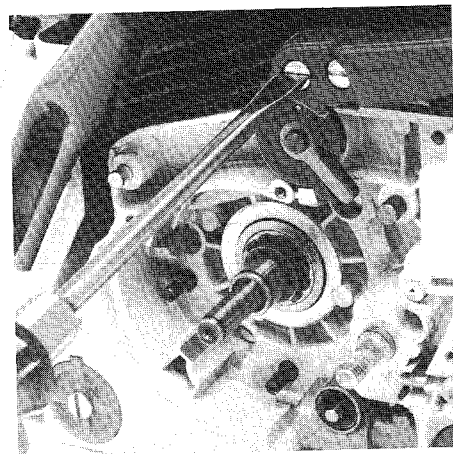
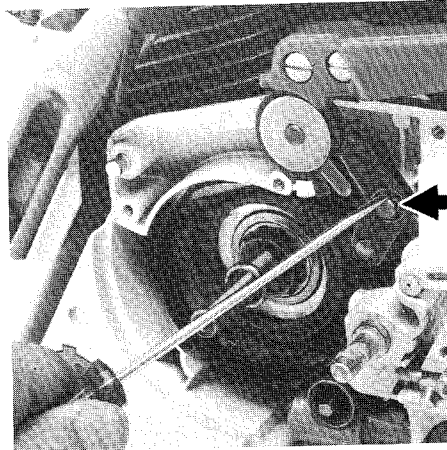
Top:
Removing retaining washerCenter and Bottom:
Unscrewing the handguard

The spring guide pins in the crankcase must be replaced if they are damaged.

These screw pins must be bonded in position to prevent them loosening in operation. To do this, use a suitable solution (trichlorethylene, diluted nitro or similar) to completely degrease the threads in the crankcase and on the pins themselves. Then coat the threads of the screw pins with a little adhesive – 101, part number 0786 111 1101, (LOCTITE 242) – and screw them into the crankcase. Tighten to a torque of 4.9 Nm (0.5 kpm).

It is essential to use a suitable screwdriver with a tip which fits snugly in the slot of the pin in order to avoid damaging the pin material. A 1 x 6.5 screwdriver in accordance with DIN 5265 is recommended for this purpose.

2.4 Assembly

2.4.1 Chain brake

Top:
Torsion spring and relay lever in position

Bottom:
Actuating lever fitted

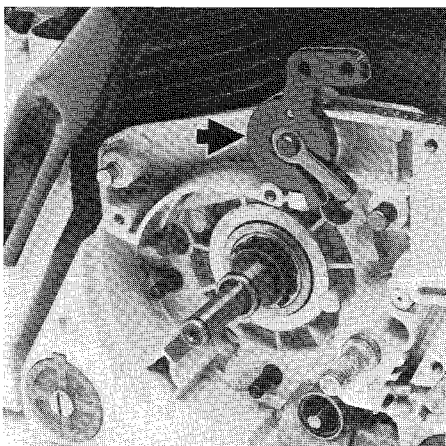
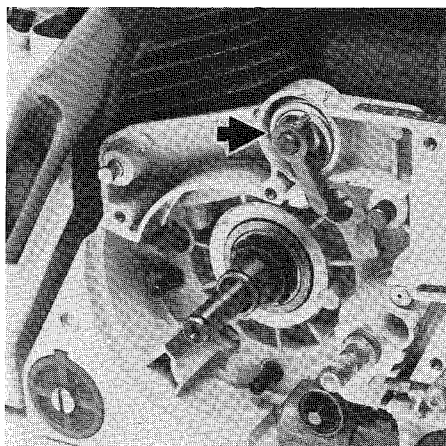

First fit the relay lever, actuating lever and handguard. The ends of the torsion spring must engage in the hole in the crankcase and the actuating lever. The M5x12 cheese-head screws must be secured with LOCTITE.

Now fit release plate in crankcase so that its slots locate over the guide pins. Fit washer, helical spring, washer and retaining washer on the guide pins in that order. Locate bent

Seat for brake band

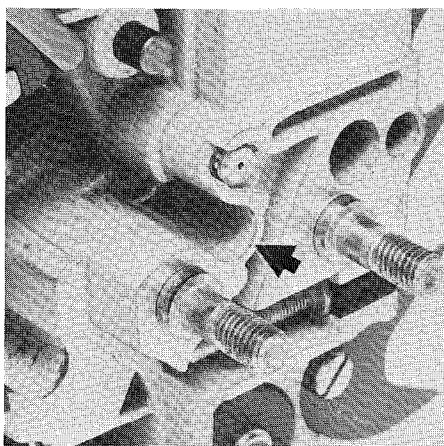

end of brake band in its seat in the crankcase and insert pivot pin of brake lever in the loop of the brake band. Fit washer, helical spring and washer on the pivot pin of the brake lever. Push lever onto pivot pin and locate pin in slot of release plate at the same time. Now secure brake lever with retaining washer and attach the tension spring using the special assembly tool.

Top:
Brake band and brake lever in position

Center:
Special assembly tool
1117 890 0900

Bottom:
Attaching the tension spring

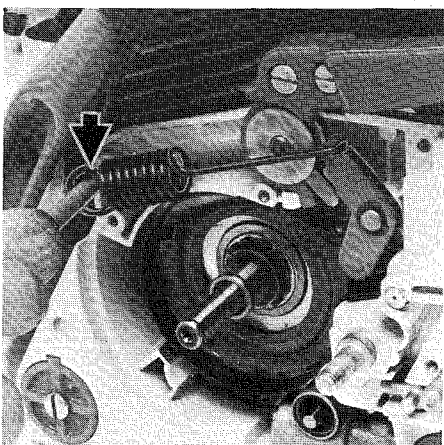
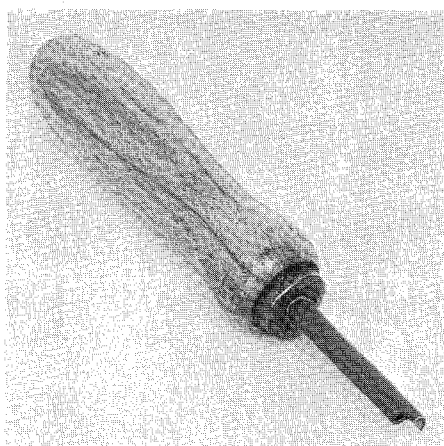
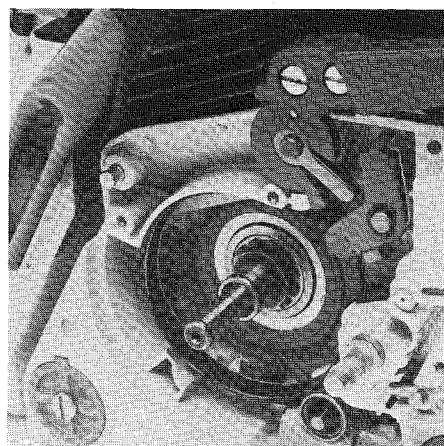

2.4.2 Clutch

Top:
Tightening the hub with a torque wrench

Bottom:
Flat spring fitted on spider lugs

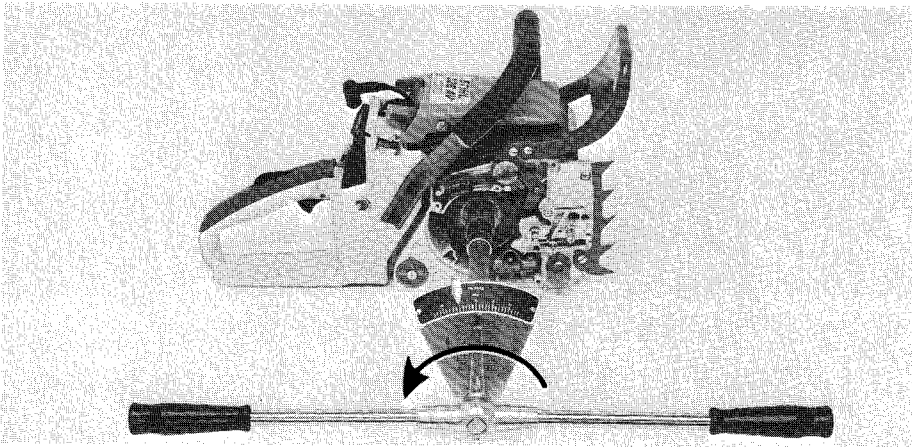

First degrease the threads on the crankshaft and hub (Quickstop) or clutch spider (standard) with a suitable solution (trichlorethylene, diluted nitro or similar).

The initial assembly operations are different on the Quickstop and standard versions.

On the **Quickstop version**, fit the flange washer on the crankshaft, screw hub counter-clockwise onto the crankshaft and tighten to a torque of 49.0 Nm (5.0 kpm) using the special socket 1118 893 1300 and a torque wrench.

It is essential to observe the specified torque as the hub may otherwise loosen during operation.

Engage the driving plate on the teeth of the hub. The chain brake must be in the released condition during this operation. Fit flat spring on lugs of clutch spider; the raised spring tabs

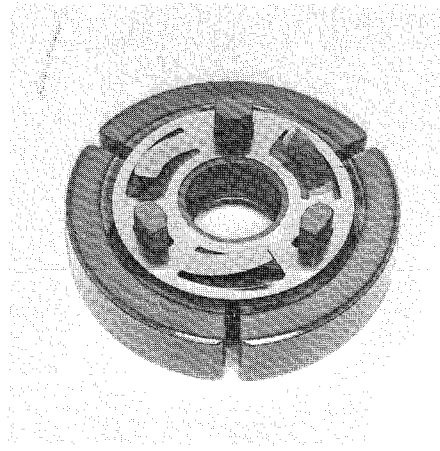

must face away from the clutch. Now push clutch together with greased needle sleeve onto the hub and turn backwards and forwards until the clutch spider lugs engage in the driving plate. Fit circlip to secure clutch.

On the **standard version**, fit cover plate on the crankshaft so that the raised outer diameter faces away from the crankcase. Screw spider of clutch assembly counter-clockwise

onto the crankshaft and tighten to a torque of 49.0 Nm (5.0 kpm) using a torque wrench with a 19 mm socket.

It is essential to observe the specified torque as the spider may otherwise loosen in operation.

The assembly procedure is now the same for both versions.

Lubricate needle sleeve of clutch drum with antifriction grease and fit it on the crankshaft.

Push clutch drum onto crankshaft and needle sleeve and then fit spur gear onto oil pump shaft. Slip ring gear onto hub of clutch drum.

Finish off by fitting cover and chain sprocket; remove the locking screw, fit and tighten down the spark plug.

3. ENGINE

3.1 Construction

Series 028 chain saws are powered by an air-cooled, single cylinder two-stroke engine.

The crankcase is a two-part pressure die-casting made of a special magnesium alloy. The two-part drop-forged crankshaft is supported in two deep-groove ball bearings. Two oil seals, in the crankcase at the ignition side and in the ball bearing

at the other side, hermetically seal the crank chamber.

The connecting rod, also drop-forged, is supported on needle cages both on the crankpin and the piston pin. Once the needle cage and the connecting rod have been fitted, the two halves of the crankshaft are pressed together to form a torsionally rigid assembly and then

machine finished. For this reason a **replacement crankshaft can only be supplied complete with connecting rod and needle sleeve.**

Cylinder and piston are made of a special aluminum alloy. The cylinder bore is impregnated in a special process.

3.2 Troubleshooting Chart

First check fuel supply, carburetor, air filter and ignition system before looking for faults on the engine.

Fault	Cause	Remedy
Engine does not start easily, stalls at idle speed, but operates normally at full throttle	Oil seals in crankcase leaking	Replace oil seals
	Elbow connector leaking	Seal or replace elbow connector
	Crankcase damaged (cracks)	Replace crankshaft
Engine does not deliver full power or runs erratically	Secondary air seepage into engine through poorly mounted or faulty elbow connector	Mount elbow connector correctly or replace
	Piston rings leaking or broken	Replace piston rings
Engine overheating	Insufficient cylinder cooling. Air inlet opening in fan housing blocked or cooling fins on cylinder plugged	Thoroughly clean all cooling air openings

3.3 Exposing the Cylinder

3.4 Disassembly of Cylinder and Piston

Top:
Removing the shroud

Bottom:
Unscrewing the muffler

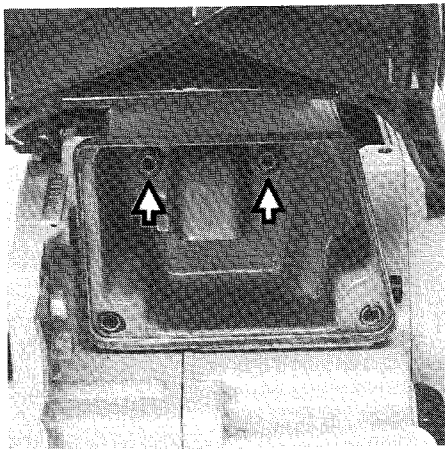
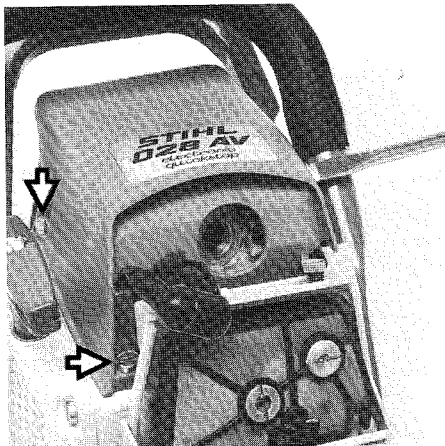

First remove carburetor box cover, unscrew spark plug and take off the shroud and two-part muffler.

The cooling fins of the cylinder are now easily accessible and can be cleaned thoroughly. Check for damage (cracks, broken cooling fins, etc).

Removing the cylinder base screws

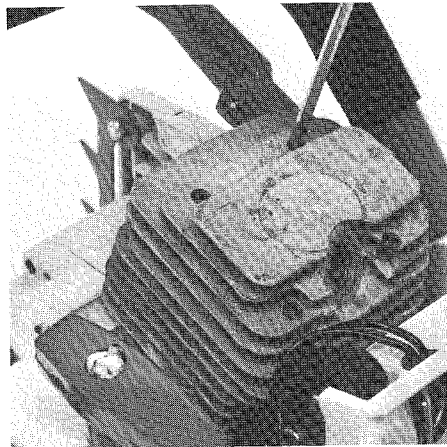

Drain fuel and oil tanks. Remove the carburetor (see 10.4) and unscrew the four cylinder base screws. Carefully pull the cylinder off the piston and press the elbow connector forwards and out of the tank housing.

Before removing the piston it must be decided whether or not the crankshaft is to be removed, i.e. the wooden block used to lock the crankshaft – to facilitate removal of the flywheel and hub (Quickstop) or clutch spider (standard) – must be fitted between the crankcase and the piston.

To remove the piston, first take out the two wire retainers and press the piston pin out of the piston and needle cage by means of drift 1110 893 4700.

If the piston pin is stuck as a result of carbonization, tap it out lightly with a hammer and the drift. It is

Top:
Removing the wire retainers

Bottom:
Pushing out the piston pin

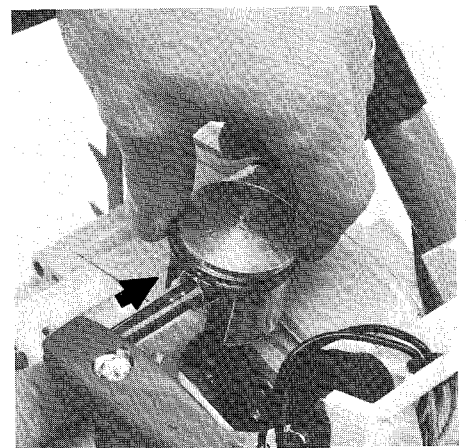
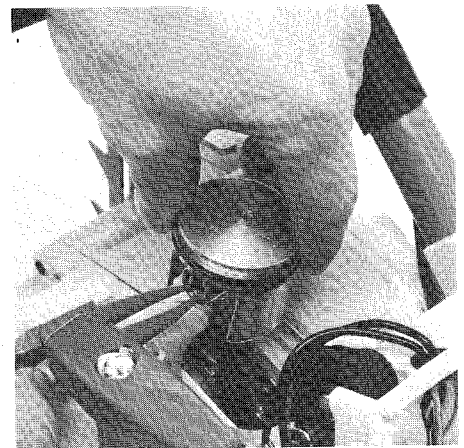

essential to counterhold the piston to insure that no jolts are transmitted to the connecting rod. Remove the piston.

3.5 Reassembly of Piston and Cylinder

Arrow and "A" point towards exhaust port

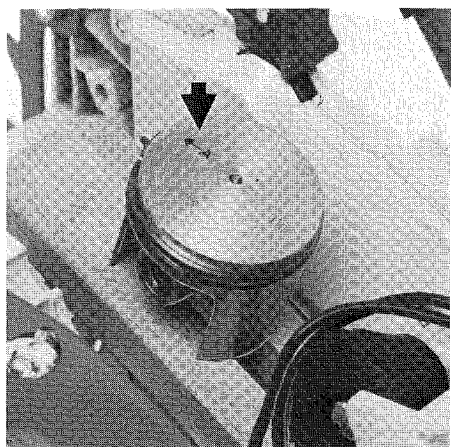

If the cylinder has to be replaced the new cylinder must always be installed with a matching piston. Replacement cylinders are only supplied complete with piston.

If only the piston is to be renewed, every replacement piston (marked "B") can be used with any cylinder.

Before installing the piston, lubricate the needle cage with oil and insert it in the connecting rod. Position piston on connecting rod so that the stamped markings (arrow and A) point towards the cylinder exhaust port (towards tip of guide bar). Now fit piston pin in piston and connecting rod (needle cage). To do this, push assembly drift through piston bore and connecting rod to align piston both bores concentrically. Fit piston pin on spigot of assembly drift and slide into piston. Gently move piston to and fro to ease insertion of piston pin.

Fitting the piston pin

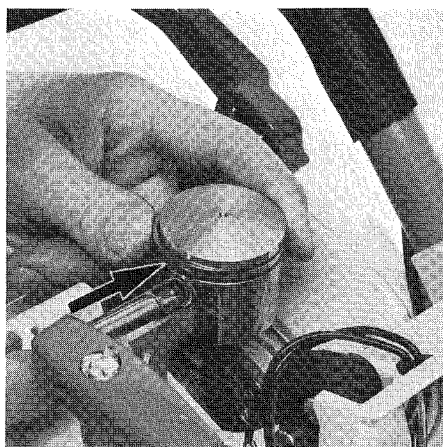

The piston pin must move freely in its bore. Never use force during assembly.

Insert the two wire retainers and make sure that they are properly seated.

Mounting of the cylinder is best carried out using the wooden assembly block and the ring compressor 1113 893 4900 or clamping strap 0000 893 2600.

The elbow connector must be fitted if a new cylinder is used. To insure a perfect seal, coat the inside of the elbow connector's neck with sealing paste 0783 810 1101. Fit elbow connector on the intake stub so that it faces upwards (towards cylinder head) and the moulding seam is vertical (parallel with cylinder center line). Then secure elbow connector

Top:
Wooden assembly block, ring compressor and clamping strap

Bottom:
Elbow connector in position

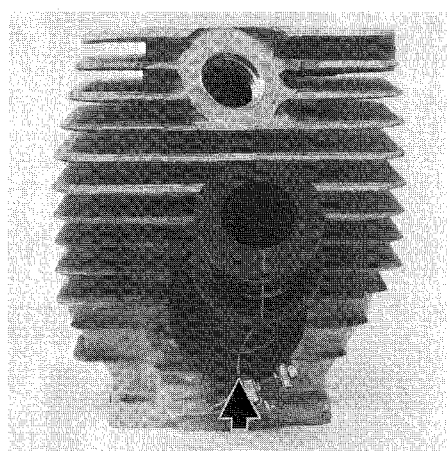
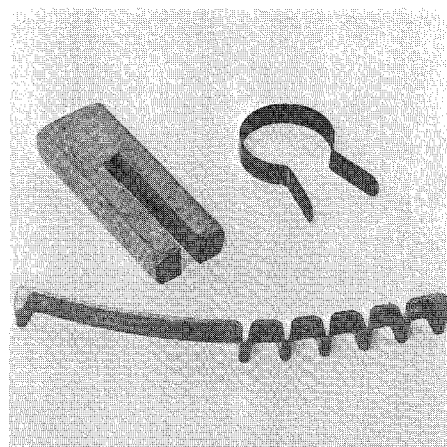

with hose clamp, making sure that the clamp is correctly seated and does not distort the elbow connector when tightened down.

Top:
Piston on wooden assembly block

Bottom:
Piston rings correctly positioned

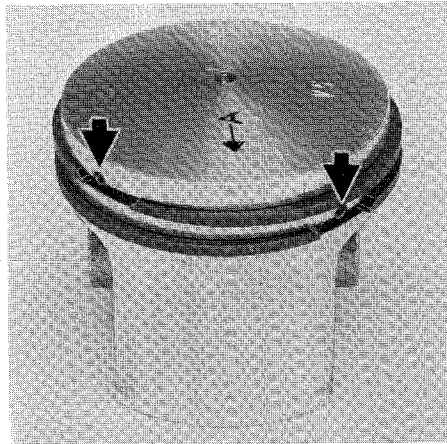
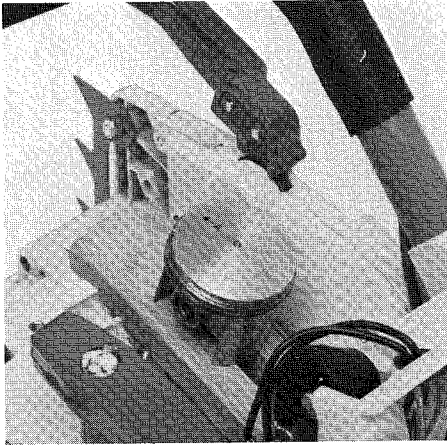

Fit new cylinder gasket on the crankcase. Lubricate piston and piston rings with oil. Place wooden block on the crankcase so that piston is resting on it.

Position each piston ring so that the radii at the ring gaps locate against their respective fixing pins in the piston grooves.

Fitting the cylinder

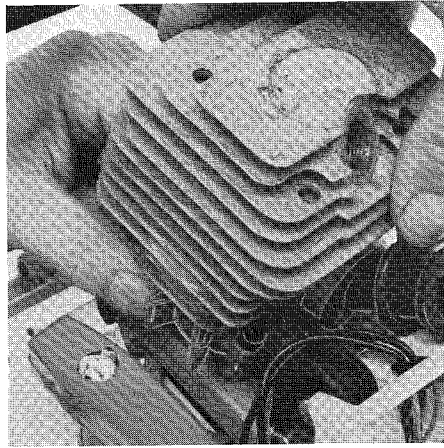

Insert the four M 5 x 16 socket head screws in the cylinder mounting holes. Using the ring compressor or clamping strap, compress the piston rings while making sure they are correctly positioned. Fit cylinder over the piston with the exhaust port facing in the direction of the guide bar tip. During this process make sure that the cylinder is properly aligned, i.e. the outer edges of the cooling fins must be exactly parallel with the outer edge of the crankcase at the sprocket side. If this alignment is not carried out, the piston rings may break. The ring compressor is pushed downwards as the piston rings move into the cylinder. Remove wooden assembly block and ring compressor. Push flange of elbow connector through the bore in the tank housing (do not use a sharp tool for this purpose) and align the cylinder gasket and cylinder. Tighten down the four cylinder base screws to a torque of 7.8 Nm (0.8 kpm) in a diagonal pattern.

Tightening cylinder base screws with torque wrench

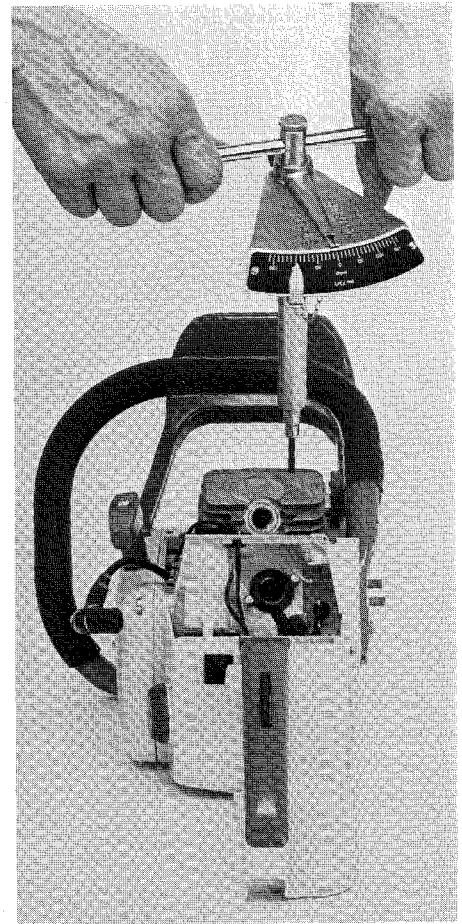

Insert sleeve in elbow connector and then refit carburetor (see 10.4), muffler, shroud, spark plug and carburetor box cover.

**3.6 Disassembly of Crankcase –
Removal of Crankshaft**

Bottom:
Detaching brake spring

Bottom:
Handguard and relay lever removed

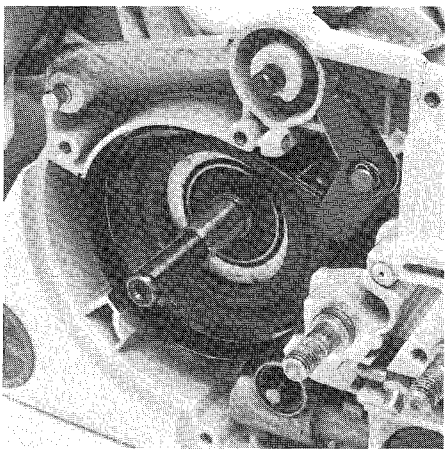
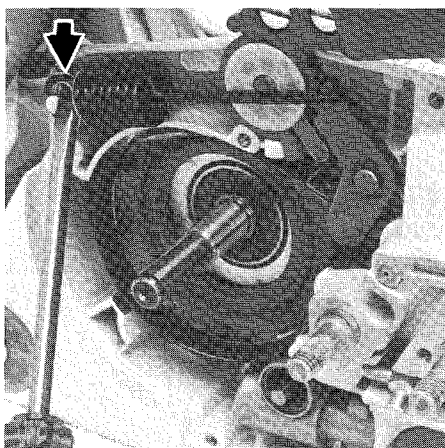

It is necessary to remove the clutch (2.3.1), hub (Quickstop only), fly-wheel (4.4.5), generator (8.3.4) and flange, cylinder and piston (3.4) to gain access to the crankshaft. Detach the brake spring and take off the handguard together with actuating lever and relay lever.

Now remove the tank housing. Proceed as follows:

Top:
Disconnecting pulse hose

Bottom:
Removing short-circuit wire

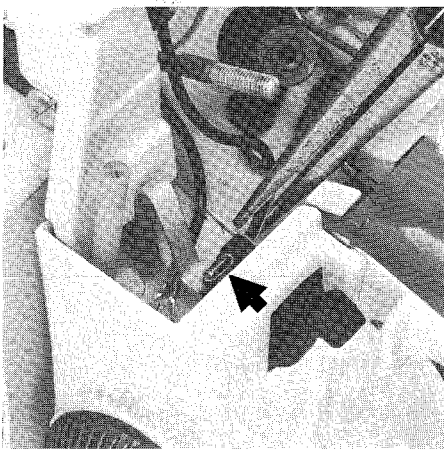
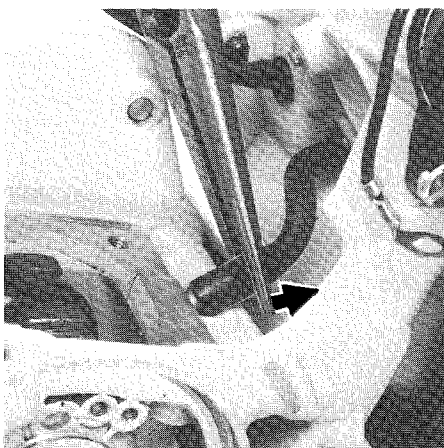

Disconnect pulse hose from stub in crankcase and pull short-circuit wire out of contact cam and rubber grommet in tank housing. Now release the tank housing from the vibration mounts by removing the respective screws (see 6.2).

The tank housing can now be lifted off together with the handlebar.

Top, center and bottom:
Unscrewing vibration mounts

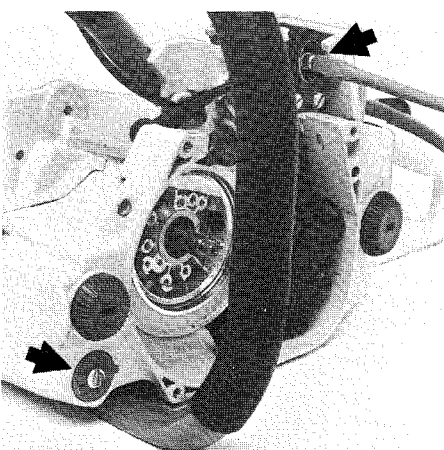
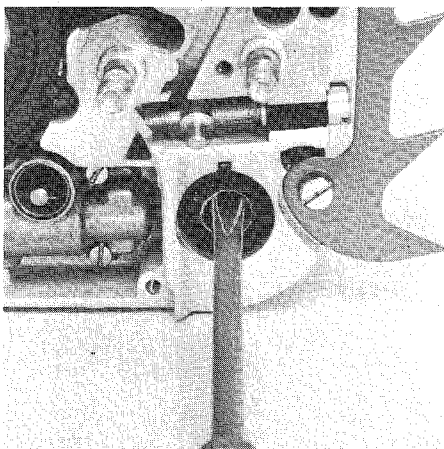
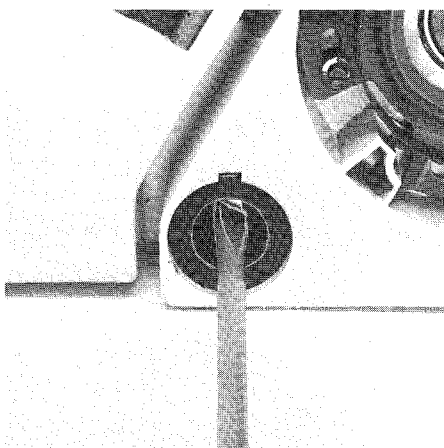

Top:
Crankcase mounting screws

Bottom:
Knocking back a cylindrical pin

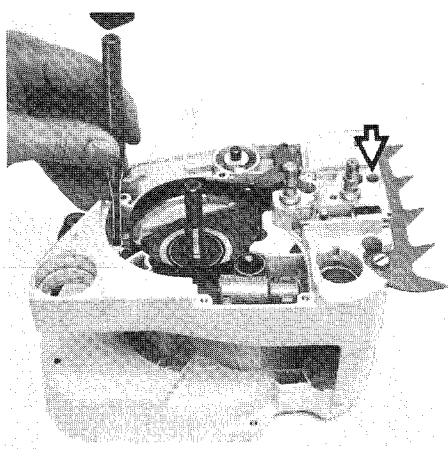
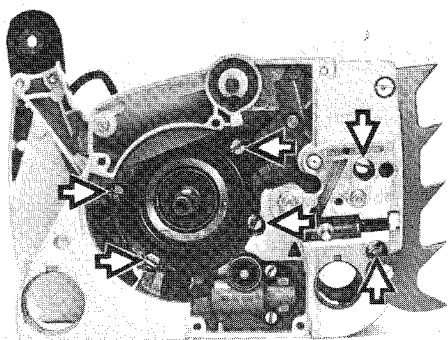

Unscrew the six crankcase cheese-head mounting screws. Use a suitable tool, e.g. 5 mm diameter drift, to knock the two cylindrical pins back into the crankcase half on the ignition side.

Top:
Driving out the crankshaft

Bottom:
Knocking out the oil seal

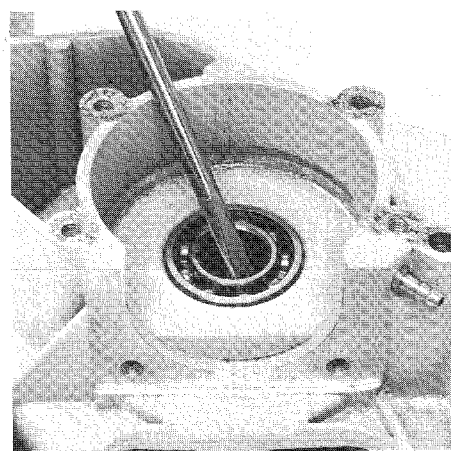
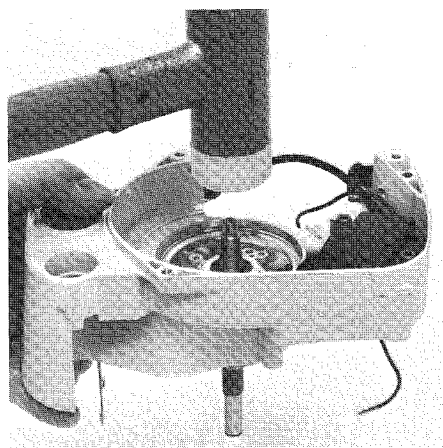

Remove key from crankshaft stub at ignition side. Hold both halves of the crankcase and use a soft-nosed hammer to knock the crankshaft out of the bearings.

Use a screwdriver or similar suitable tool to knock the oil seal out of its seat in the crankcase at the ignition side. Use arbor 1118 893 7200 to press both ball bearings inwards and out of their seats in the crankcase.

Top:
Pressing out ball bearing at ignition side

Bottom:
Pressing out ball bearing at sprocket side

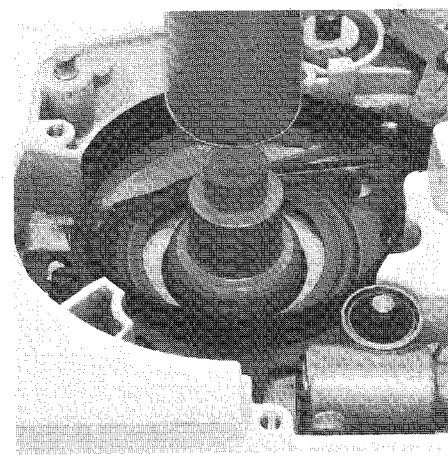
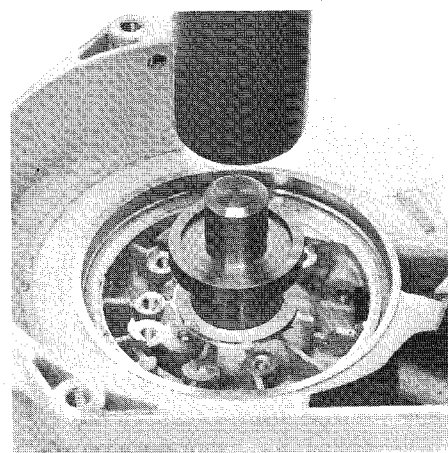

3.7 Installing the Crankshaft – Assembly of Crankcase

Crankshaft with needle cage
and piston pin

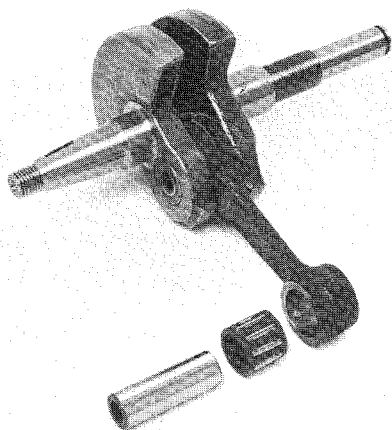

The crankshaft, connecting rod and needle bearing are inseparable. This means that the crankshaft must always be replaced as a complete unit in the event of damage to any one of these parts.

When fitting a replacement crankshaft it is advisable to renew the ball bearings and oil seals as well. New oil seals should always be fitted.

If the crankshaft is damaged it must be replaced as a **complete** unit. All the other parts which are still serviceable must then be transferred from the old to the new crankcase after the new bearings have been fitted, i.e. the crankcase has to be heated for this purpose.

Top:
Cleaning the sealing faces

Bottom:
Snap-ring fitted

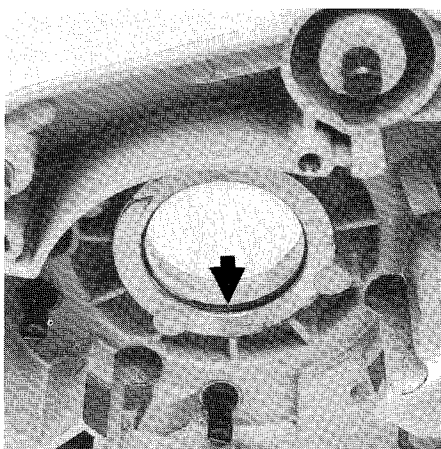
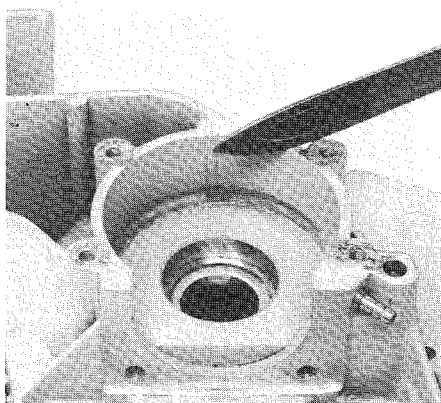

If the old crankcase is used again, remove gasket and clean sealing faces with a scraper.

If a new crankcase is to be fitted, first insert a new snap-ring in the annular groove of the bearing seat at the clutch side. Heat both halves of the crankcase on a heating plate to approx. 150 – 180° C. Fit ball bearings squarely – without canting – from the inside of the crankcase so that the outer races locate against

Top:
Special assembly arbor
1118 893 7200

Bottom:
Pressing in ball bearing at ignition side

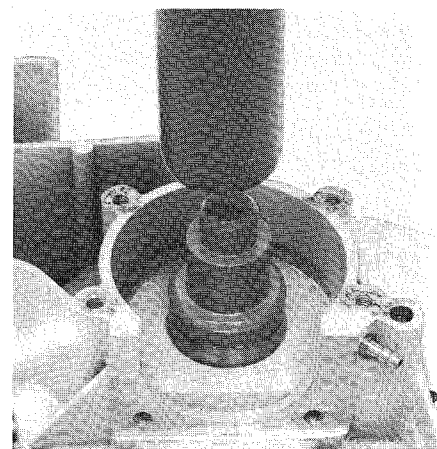
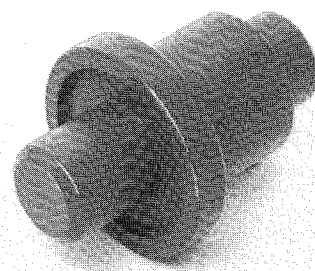

the shoulder of the bearing seat of the snap-ring. If the crankcase is heated to the specified temperature the ball bearings can be inserted by hand. If the crankcase cannot be heated, press in both bearings with the large end of the assembly arbor 1118 893 7200.

Crankshaft inserted as far as crank web shoulder

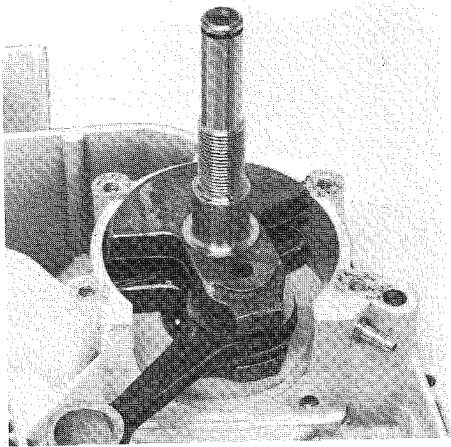

The inner races of the ball bearings must also be heated before the crankshaft is fitted. This is best done with a soldering iron and an appropriate attachment. Then insert tapered stub of crankshaft into bearing at ignition side until the crank web shoulder locates against the inner race.

Coat the sealing faces of both crankcase halves with sealing paste 0783 810 1101, if available. Fit new gasket on crankcase at ignition side and drive in cylindrical pins until they project about 1 mm and thus hold the gasket. Fit inner race of bearing at clutch side over the straight stub of the crankshaft, place the two halves of the crankcase together and align. Drive the two cylindrical pins fully home, insert screws and tighten to a torque of 4.9 Nm (0.5 kpm) in a diagonal pattern. Trim away any excess gasket material in the area of the cylinder mounting face.

Top:
Oil seal fitted over assembly sleeve

Bottom:
Pressing in oil seal at clutch side

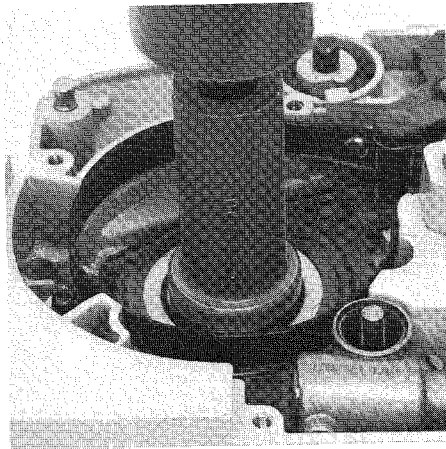
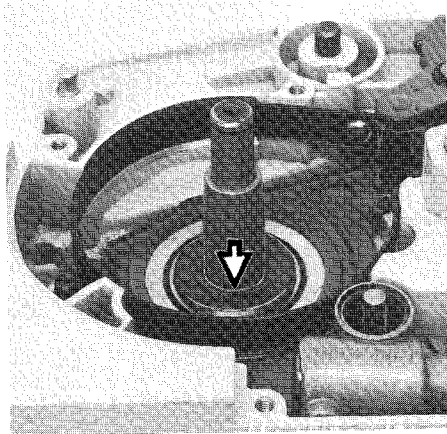

Before fitting the oil seal at the clutch side, pack the cavity between the dust lip and sealing lip with grease 0781 120 1109. Then slip assembly sleeve 1118 893 4600 over the straight stub of the crankshaft and push the oil seal, sealing lip first, onto the sleeve and press into position with press sleeve 1118 893 2400 until it is flush with the front edge of the ball bearing. The oil seal at the ignition side is pressed in with the press sleeve

Pressing in oil seal at ignition side

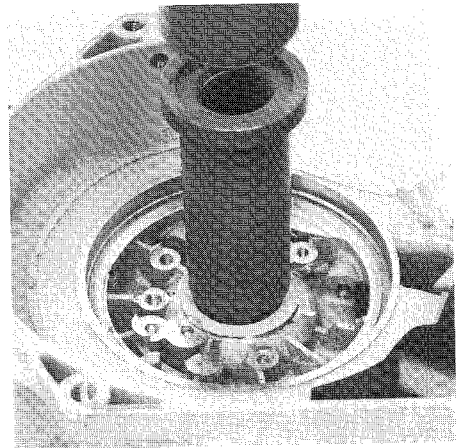

1118 893 2400 until it is flush with the front edge of the bore. The assembly sleeve is not necessary in this case as the tapered crankshaft stub has no sharp edges which could damage the sealing lip.

Assembly of the remaining parts is a reversal of the disassembly procedure. If a new crankcase has been fitted it will be necessary apply a new timing mark. To do this, set the ignition timing exactly (4.5.2) and apply the mark.

3.8 Leakage Testing the Crankcase

Top:
Carburetor and crankcase tester

Bottom:
Vacuum pump

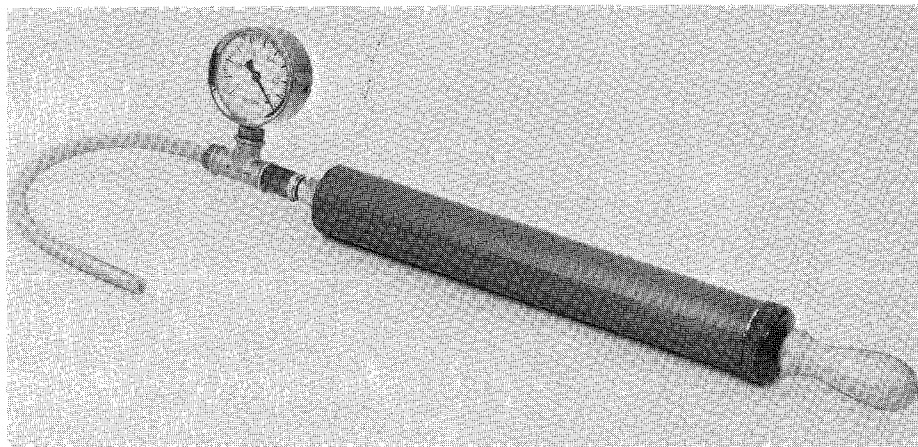
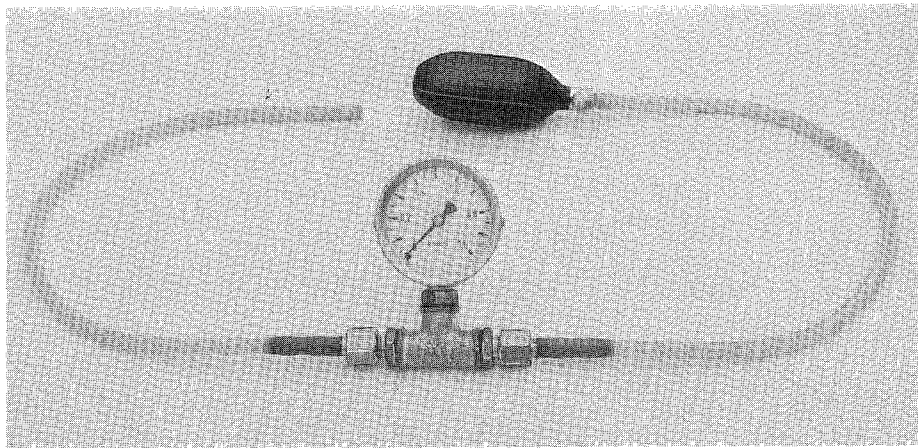

Defective oil seals and gaskets, cracks or blow-holes in castings are the usual causes of leaks. Such faults allow supplementary air to enter the engine and thus upset the fuel-air mixture.

This makes adjustment of the prescribed idle speed difficult or even impossible. Moreover, the transition from idle speed to part or full load is not smooth.

The crankcase can be checked accurately for leaks with the carburetor crankcase tester 1106 850 2900 and the vacuum pump 0000 850 3500.

3.8.1 Testing with Overpressure

Top:
Test and blanking flange

Bottom:
Blanking flange in position

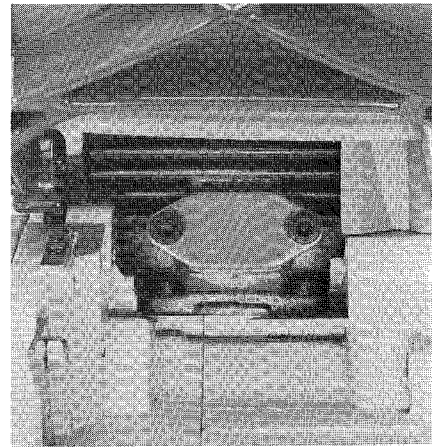
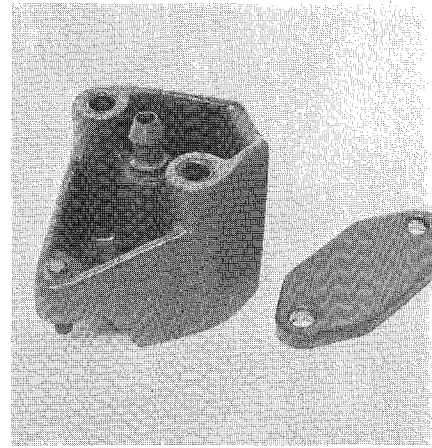

Remove the carburetor (see 10.4) and muffler. Seal the cylinder's exhaust port with flange 1113 855 4205 using the exhaust gasket and the upper M 5 x 16 muffler mounting screws. The shroud has to be removed if the new sealing plate 0000 855 8105 is used in place of flange 1113 855 4205, and the muffler can remain in position on the engine. However, the mounting screws must be slackened off so that the sealing plate can be inserted.

Sealing plate in position

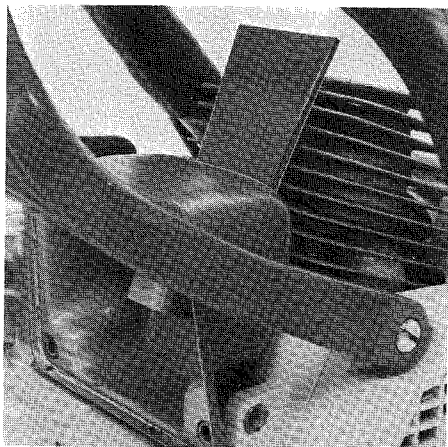
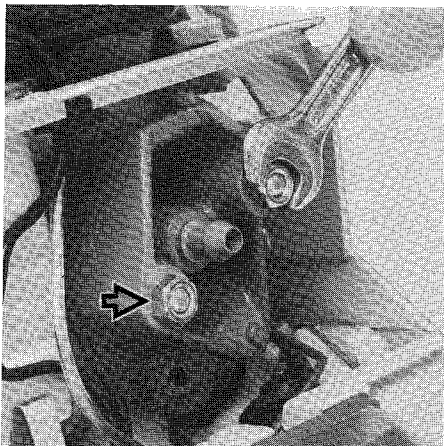
Top:
Securing the test flangeBottom:
Pressure-testing the crankcase

Pressure hose connected

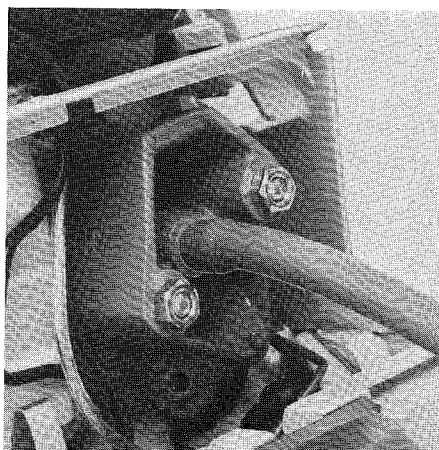

ted, narrow side first, from above between the cylinder exhaust port and the muffler. Then tighten the upper M 5 x 16 mounting screws moderately. The sealing plate effectively seals off the cylinder exhaust port.

Push test flange 1118 850 4200 onto the studs in the tank housing (carburetor seat) so that the cylindrical pin locates in the pulse hose and seals it airtight. Now fit the two M 5 nuts onto the studs and tighten down so that the flange is pressed against the elbow connector to insure a good seal.

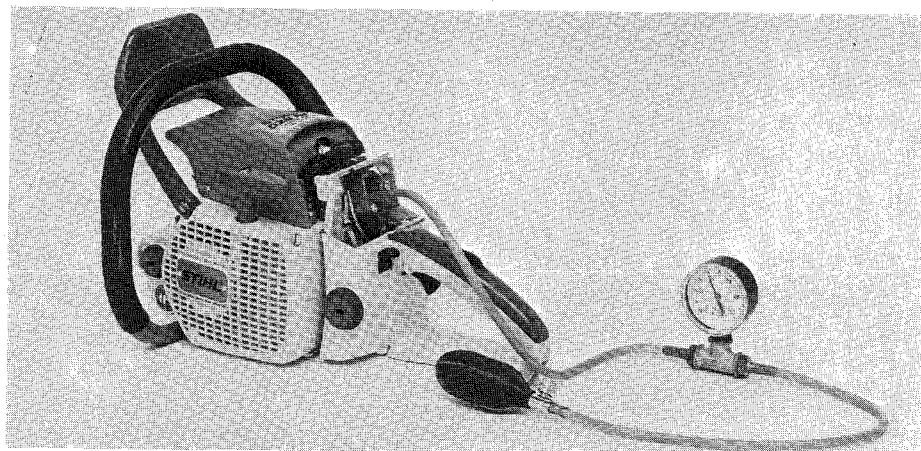

The spark plug must be properly tightened down and the piston at top dead center (T.D.C.).

Connect pressure hose to nipple of test flange and close the bleed screw on the rubber bulb. Pump air into the crankcase until the gauge indicates an overpressure of 0.5 bar (kp/cm^2). If this pressure remains constant, the crankcase is properly sealed. However, if the pressure

drops the leak must be found and the faulty part renewed.

When the test is completed, open the bleed screw and disconnect the hose.

3.8.2 Testing with Vacuum

Leakage test with vacuum pump

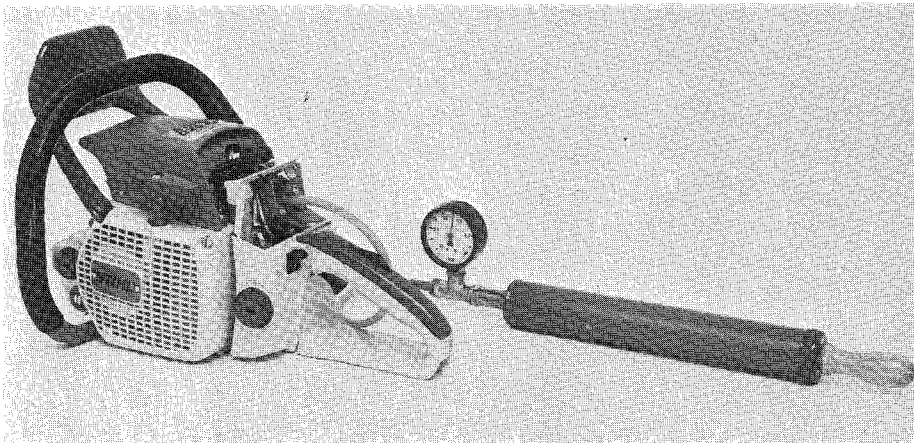

Oil seals tend to fail when subjected to a vacuum, i.e. during the piston's induction stroke the sealing lip lifts off the crankshaft owing to the lack of any counterpressure.

An additional test can be carried out with the vacuum pump. The preparations for this test are the same as for the overpressure test (3.8.1).

Connect suction hose of vacuum pump to nipple of test flange. Pull out pump piston until the gauge indicates a vacuum of 0.5 bar (kp/cm^2). When the pump piston is released, the non-return valve automatically closes the suction hose. If the vacuum reading remains constant, or rises no further than 0.3 bar (kp/cm^2), the oil seals are in good condition. However, if pressure continues to rise (up to $p = 0$ bar),

the oil seals must be replaced even if no leaks were found in the previous overpressure test.

3.8.3 Replacing the Oil Seals

Puller in position

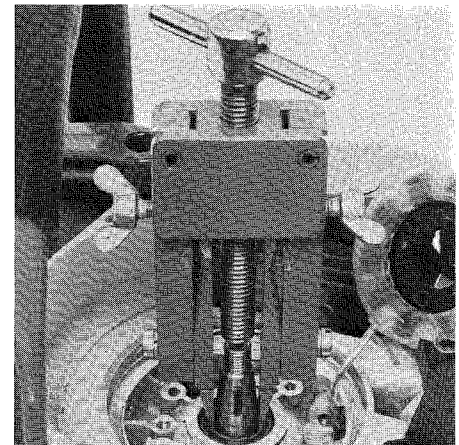

If only the oil seals need to be replaced, this operation can be carried out without disassembling the engine. To do this, remove clutch (standard) or hub (Quickstop), flywheel and triggerplate or contact set and condenser.

The oil seal at the ignition side can be pulled out of its seat in the crankcase with puller 0000 890 4400. No. 3 jaws must be fitted in the puller for this purpose. The oil seal at the clutch side is prised out with a screwdriver. Caution. In the case of the oil seal on the ignition side, make sure that the sealing face of the crankshaft is not damaged. On the oil seal at the clutch side, care must be taken not to damage the ball cage of the bearing.

Install the new oil seals as described under 3.7.

4. IGNITION SYSTEM

4.1 Construction

4.2 Operation

4.2.1 General Information

Like all other STIHL chain saws the series 028 saws are equipped with a magneto ignition system which requires neither a battery nor a dynamo. Different ignition systems are installed in the various versions of the chain saw. Breaker-controlled magneto ignition systems and breakerless (electronic) magneto ignition systems are used here. There are two types of breakerless ignition systems, i.e. transistor or thyristor controlled.

The Bosch ignition systems (both breaker and transistor-controlled) are of a component-type construction and consist of three main parts – the flywheel (magnet wheel), the ignition armature and the control unit. The SEM ignition system is a compact construction and consists of only two main parts – the flywheel (magnet wheel) and the ignition module.

The flywheel of both types carries the permanent magnet with a north and south pole and is located on the crankshaft stub. The ignition armature (Bosch), or the ignition module (SEM), is mounted in the crankcase on the periphery of the flywheel so that it can only be adjusted in the radial direction. In the ignition module (SEM) the primary stage, ignition transformer and electronic switch unit, are combined in a single unit and embedded in a moisture-proof plastic compound.

The control components of Bosch ignition systems, i.e. the contact set with condenser on the 028 AV/028 AVQ and the switch unit on the 028 AVE, are fitted in the crankcase behind the flywheel. All electronic control components are incorporated on a common printed circuit board and embedded in a moisture-proof plastic compound in the ring-shaped switch unit.

The flywheel magneto ignition system operates on the basis of magnetic induction. On both the breaker-controlled and transistor-controlled ignition systems this involves only "dynamic induction", while "static induction" also occurs in the thyristor-controlled magneto capacitor ignition system.

In the case of **dynamic induction** the electric current is generated in a conductor in that the conductor is moved through the flux lines of a magnitude of the induced voltage is, among other things, dependent on the strength of the magnetic field and the speed of the flux change. This in turn is influenced by the intensity of the movement.

In respect of the magnetic ignition system, this means: as the flywheel rotates, the flux lines flowing between the permanent magnets, from north pole to south pole, create a magnetic flux in the iron core of the coils. The flux lines of this magnetic field cut through the wire windings of the coil and induce a low-tension current. The magnitude of the voltage is thus dependent on the rotational speed of the flywheel.

4.2.2 Breaker-controlled Ignition System

Diagram of ignition system:

- | | |
|--|------------------------|
| 1 Flywheel | 4 Breaker points |
| 2 Permanent magnet with north and south poles and pole shoes | 5 Condenser |
| 3 Armature with primary and secondary windings | 6 Spark plug |
| | 7 Ignition stop switch |
| | 8 Armature air gap |
| | 9 Magneto edge gap |

In the case of **static induction** on the other hand, the voltage in a conductor is created in that the magnetic field – in which the conductor is situated, generated by an electric current, changes its strength or flow direction (transformer principle). Among other things, the magnitude of the induced voltage is dependent on the strength of the primary current which the magnetic field generates, and the ratio of turns between the primary coil and secondary coil (transformation ratio).

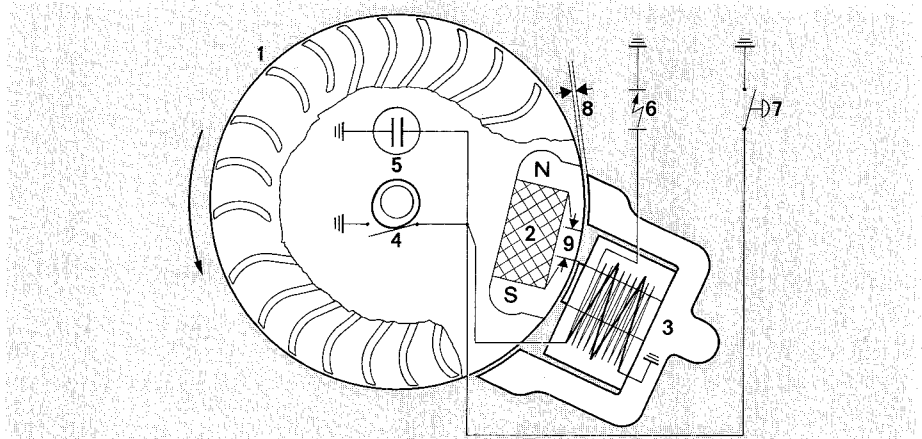

When the magnet poles of the rotating flywheel pass the iron core of the armature coils, a low-tension voltage is induced in the coils as a result of the magnetic flux.

Without any form of control the magnetic flux would rise and fall like a sine-wave and finally change direction. The same applies for the electric voltage. However, the magnitude of a voltage pulse generated in this way would not be sufficient to produce a sparkover.

This means, therefore, that the voltage curve must be controlled; in this system the mechanical contact breaker performs this function. The contact breaker points are opened by the cam lobe ground on the hub of the flywheel and closed by spring action. At the moment of maximum magnetic flux the breaker points and thus the primary current circuit are closed. The induced voltage thus allows a current to flow in the pri-

mary winding which builds up a magnetic field (armature field) around the coil. This is opposed to the induced magnetic field (exciter field) and counteracts its tendency to change the flux direction. The further the flywheel rotates, the greater the tendency of the exciter field to change the flux direction, and the opposing armature field and thus the primary current must also increase accordingly. When the current finally reaches its maximum value, the contact breaker opens the primary circuit – this instant is called "magneto edge gap". This causes the magnetic field in the armature core to suddenly change direction and induced a high-tension pulse in the secondary winding of the armature because of its high number of turns.

4.2.3 Transistor-controlled (breakerless) Ignition System – Bosch

Diagramm of ignition system:

- | | |
|--|------------------------|
| 1 Flywheel | 4 Trigger plate |
| 2 Permanent magnet with north and south poles and pole shoes | 5 Spark plug |
| 3 Armature with primary and secondary windings | 6 Short-circuit switch |
| | 7 Armature air gap |

This pulse is fed via the high-tension ignition lead to the spark plug and is discharged as a sparkover from the center to the ground electrode and thus ignites the fuel-air mixture.

A condenser is wired in parallel with the contact breaker in the primary circuit in order to prevent excessive sparking (arcing) between the points when they open and therefore insures that there is no loss of energy or premature wear.

In order to stop the engine, the primary circuit is permanently closed by means of the short-circuit switch. This suppresses the abrupt change in direction of magnetic flux so that no high-tension pulse can be induced.

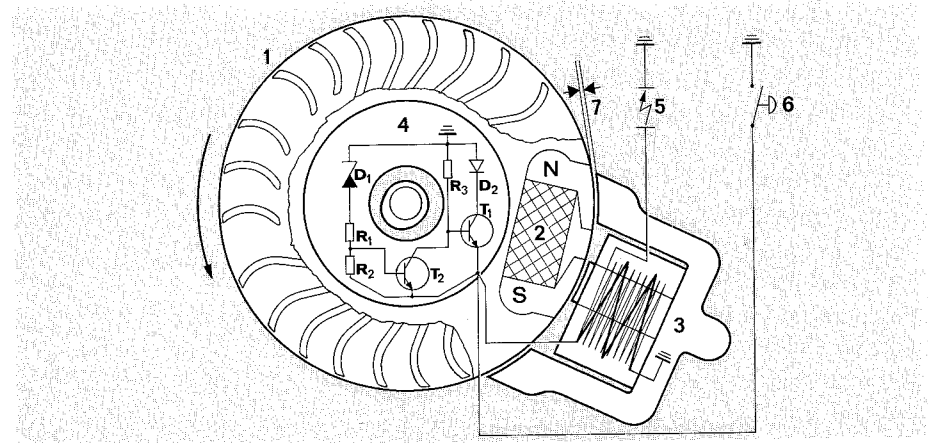

The description under 4.2.2 also applies to this type of ignition system with the exception that transistors are used as electronic switches to perform the control function in place of the mechanical contact breaker. The whole system can be divided into an input circuit and a control circuit.

The primary winding of the ignition coil, diode D_2 (rectifier) and transistor T_1 are wired in series in the input circuit. The input current flows from the primary winding via the diode D_2 – which only allows the positive halfwave to pass through – and the transistor T_1 and then back to the ignition coil.

The transistor T_1 must be conductive to allow the input current to flow. This is achieved by the primary voltage positively triggering the base of T_1 via resistor R_3 at the point of maximum magnetic flux.

The control circuit is formed by the primary winding of the ignition coil, zener diode D_1 , the resistances R_1 and R_2 (voltage dividers) and the transistor T_2 . Voltage rises as the input current increases. The voltage rises to the breakdown value of the zener diode D_1 just before the input current reaches its highest value. D_1 becomes conductive – the control circuit is closed, the base of T_2 is positively triggered, T_2 becomes conductive. The control current for T_1 now flows via T_2 , thus making the potential at the base of T_1 negative. T_1 inhibits current flow and the input circuit is open. This corresponds to the opening of the contact breaker.

The process up to sparkover then takes place as described under 4.2.2.

4.2.4 Thyristor-controlled (breakerless) Magneto Capacitor Ignition System – SEM

This type of ignition system differs from those described under 4.2.2 and 4.2.3 basically in that the primary voltage at the point of ignition does not need to be generated inductively, but is already stored. It, therefore, follows that the high-tension pulse is fed to the spark plug without any time delay at the point of ignition and thus insures a stable ignition spark.

During each rotation of the flywheel the thyristor is triggered (initiation of ignition process) and the storage capacitor charged consecutively. The following description of this ignition system therefore begins with the charging of the storage capacitor.

4.2.4.1 Charging the Storage Capacitor

- 1 – Permanent magnet
- 2 – Charging armature
- 3 – Charging diode
- 4 – Storage capacitor
- 5 – Ignition transformer

Charging the storage capacitor

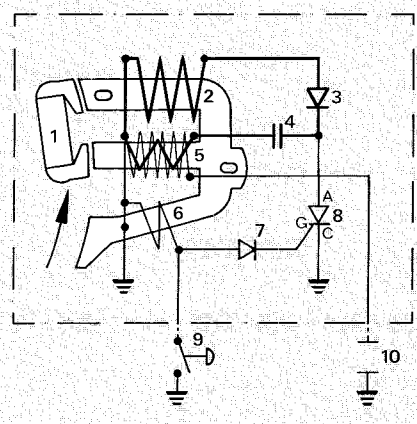

When the poles of the permanent magnets of the flywheel pass the core of the charging armature a voltage pulse is induced in the armature by the change in magnetic flux.

The winding of the charging armature is wired in series with the storage capacitor and the primary winding of the ignition transformer. The voltage pulse thus flows to the storage capacitor. However, the interposed charging diode (rectifier) only allows the positive halfwave of the pulse to pass and inhibits the negative portion so that a positive charge is stored by the capacitor.

The storage capacitor cannot deliver any energy in this operating condition as it is inhibited in the reverse direction by both the thyristor and the charging diode.

4.2.4.2 Triggering the Thyristor

- 6 – Trigger coil
- 7 – Control diode
- 8 – Thyristor
- 9 – Short-circuit contact
- 10 – Spark plug

Triggering the thyristor

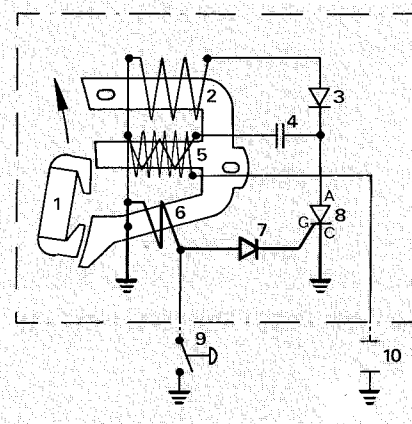

After almost a full turn of the flywheel the poles of the permanent magnet pass the iron core of the trigger coil. A change in flux again takes place and causes a voltage pulse to be induced in this coil.

The winding of the trigger coil is connected to the gate (G) of the thyristor via ground. The generated voltage pulse thus flows via the interposed control diode, which only allows the positive halfwave to pass to the gate (G) of the thyristor and allows it to become conductive in the A-C (anode – cathode) direction. The magnitude of the voltage pulse is dependent on the rotational speed of the flywheel. The voltage pulse required to trigger the thyristor is reached sooner when the flywheel speed is higher. This phenomenon explains the method of electronically displacing the ignition point on this ignition system. Ignition is, therefore, advanced proportional to the engine speed. The

4.2.4.3 Ignition

- 1 – Permanent magnet
- 2 – Charging armature
- 3 – Charging diode
- 4 – Storage capacitor
- 5 – Ignition transformer
- 6 – Trigger coil
- 7 – Control diode
- 8 – Thyristor
- 9 – Short-circuit contact
- 10 – Spark plug

Ignition process

specified ignition point (2.5 mm before T.D.C.) is reached at an engine speed of 8000 rpm.

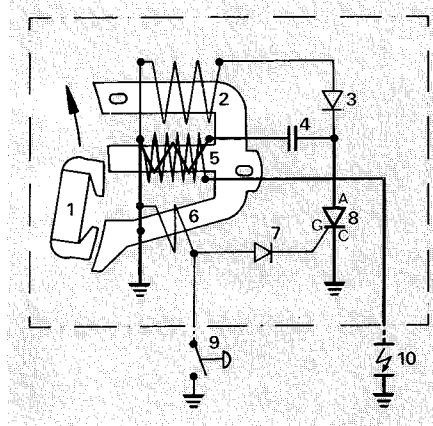

each revolution of the flywheel. The engine runs as long as this process continues.

The engine is switched off by interrupting the process. This is effected in that the control pulse from the trigger coil is connected to ground by the short-circuit contact. As a result of this, the thyristor is no longer triggered, the storage capacitor cannot discharge and no high-tension pulse can be induced.

When the thyristor becomes conductive a current path is formed from the storage capacitor via the A-C link of the thyristor, ground, primary winding of the ignition armature and back to the storage capacitor. The storage capacitor discharges via this current path and causes a sudden rise in current in the primary winding of the ignition transformer.

The high electric flux in the primary winding creates a powerful magnetic flux in the common iron core and induces a high-tension pulse in the secondary winding of the ignition transformer because of its high number of turns. This is routed via the high-tension ignition lead to the spark plug and is discharged as a sparkover from the center to the ground electrode. The fuel-air mixture is thus ignited.

This sequence of charging the storage capacitor, triggering the thyristor and ignition is repeated during

4.3 Troubleshooting

4.3.1 Breaker-controlled Ignition System

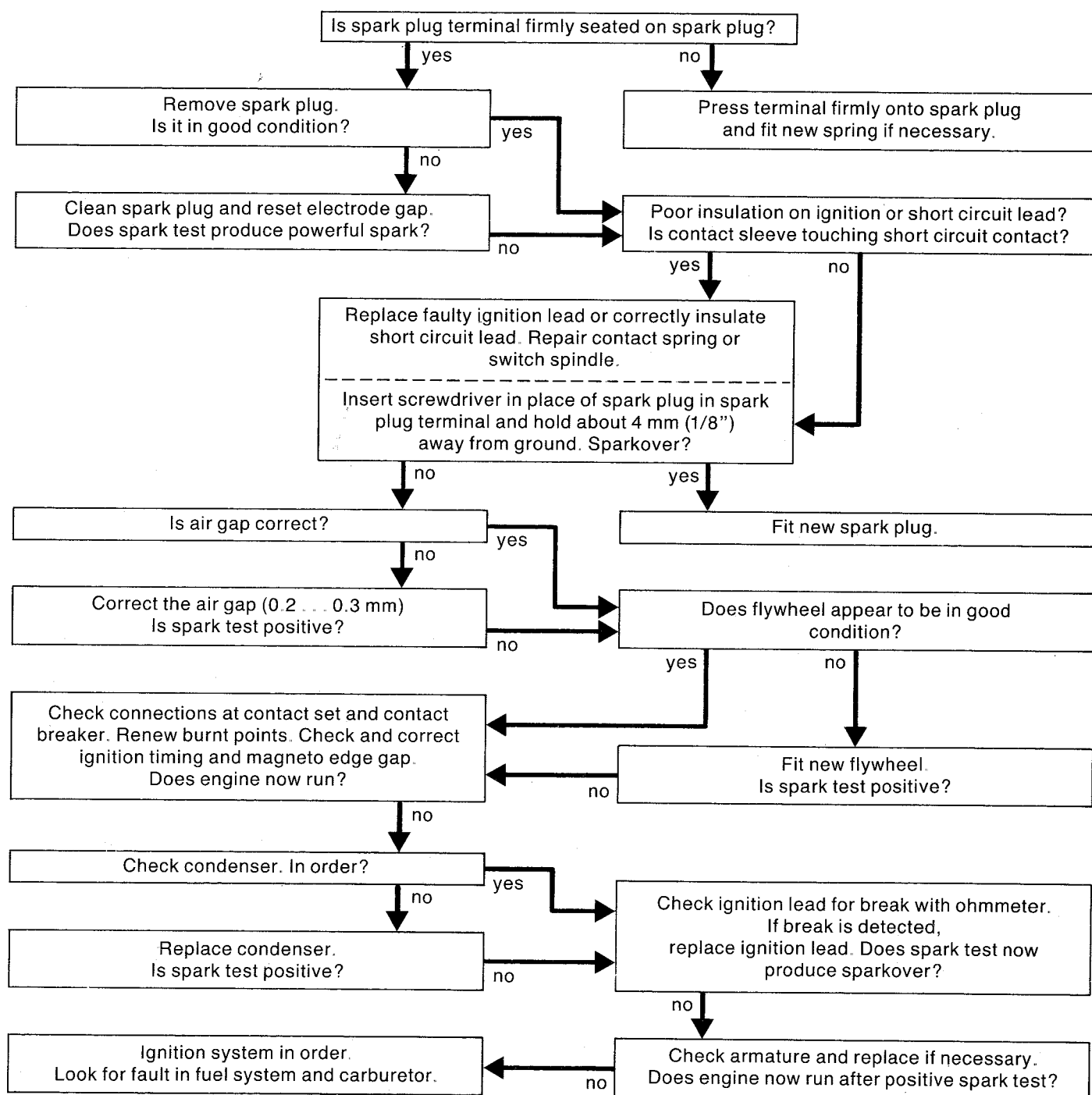

4.3.2 Electronic Ignition System

Great care must be taken during troubleshooting as well as maintenance and repair work on the ignition system. The high voltages which occur can cause serious accidents.

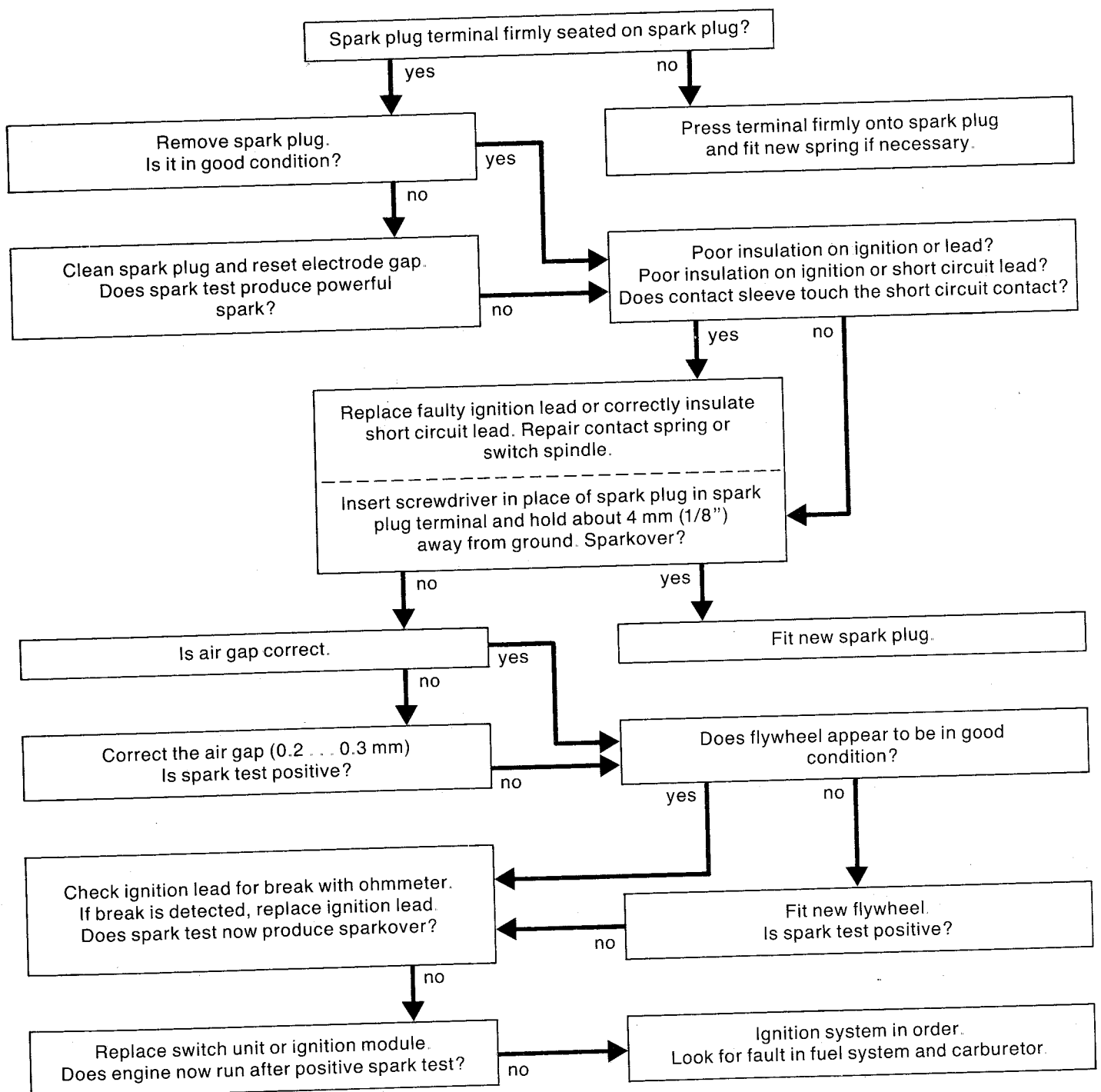

4.4 Function and Repair of Components

4.4.1 Spark Plug

The high-tension pulse generated in the ignition module is fed to the spark plug and discharges as a sparkover between the center and ground electrodes.

When the spark plug is in good condition and the electrode gap is correct, this spark ignites the fuel-air mixture.

The appearance of the spark plug's insulator nose gives important information with regard to the effects of various operating conditions:

Troubleshooting on the ignition system should always begin at the spark plug.

In the event of starting difficulties, low engine power or misfiring, unscrew the spark plug and check whether it is one of the types approved by STIHL. The Champion RCJ 6 Y suppressed spark plug is

an alternative to the standard Bosch WSR 6 F spark plug (earlier designation: WKA 200 TR 6). These spark plugs cover a greater thermal range and have better operating characteristics under extreme conditions.

Condition of insulator nose

Some associated operating conditions

Normal:

grey/yellow to brown, dry

Engine in order; spark plug heat range is correct

Sooted:

velvetlike, dull black coating of soot

Mixture too rich, lack of air (dirty air filter, choke valve partly closed), electrode gap too large, heat range too high

Smearred with Oil:

Coating of damp oil, carbon and soot

Too much oil in fuel mix

Overheated:

Welding beads on insulator nose, eroded electrodes

Mixture too lean, spark plug loose, heat range too low

Checking electrode gap with feeler gauge

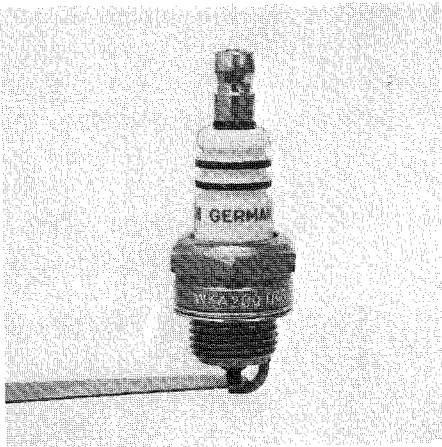

Never clean a sooted or carbonized spark plug with a steel-wire brush. Always use a brass wire brush for this purpose and then blow out plug with compressed air. If the spark plug is smeared with oil, wash it with a grease solvent and blow out with compressed air.

As the electrode gap becomes wider through normal erosion, the gap must be checked with a feeler gauge at regular intervals and readjusted. The specified gap of **0.5 mm** can be restored by bending the ground electrode. However, always fit a new spark plug if the electrodes are badly eroded.

Accurate checking of the spark plug is only possible with a special spark plug tester. A provisional check can be carried out by inserting the cleaned spark plug in the spark plug terminal, holding it against ground and cranking the engine by means of the rewind starter. There

Readjusting electrode gap with Bosch spark plug gauge

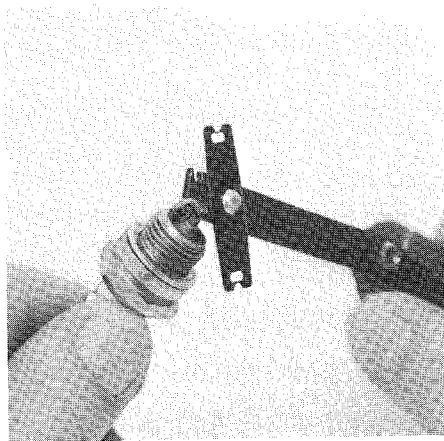

should be a powerful sparkover at the electrodes.

If there is no sparkover although the spark plug is in good condition, first check the lead connections. Chafed insulation on the ignition and ignition switch leads will cause a short-circuit to ground. If this is the case the engine will either not start or only run erratically.

Before refitting the spark plug in the cylinder, clean spark plug seat and make sure that sealing ring is in good condition. Tighten down spark plug to a torque of **24.5 Nm** (2.5 kpm).

Pulling out leg spring

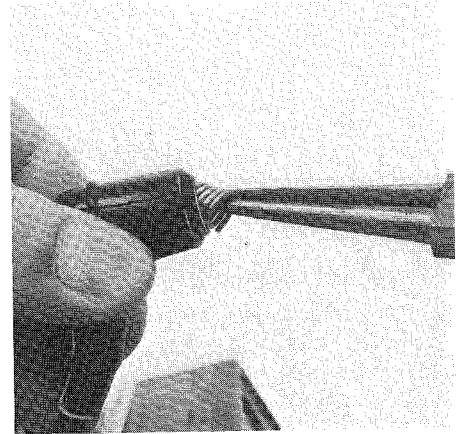

The ignition lead feeds the high-tension pulse generated in the armature (Bosch) or ignition module (SEM) to the spark plug. If its insulation is brittle or damaged in any other way, a sparkover to ground can occur and thus interrupt the ignition process. Renew the ignition lead in such a case.

To do this, remove the carburetor box cover and pull the ignition lead terminal off the spark plug. Unscrew spark plug and remove shroud and fan housing. Use a suitable pair of pliers to grip and pull leg spring out of the ignition lead terminal. Disconnect leg spring from ignition lead and pull lead out through the terminal after unscrewing it from the wood screw on the high-tension output of the ignition armature (or module).

4.4.3 Short-Circuit Wire/ Ground Wire

Top:
Unscrewing ignition lead

Bottom:
Fitting leg spring

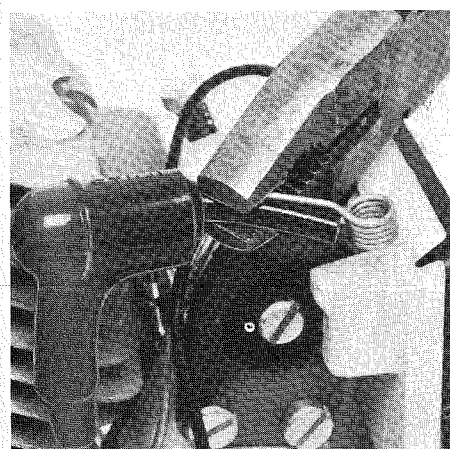
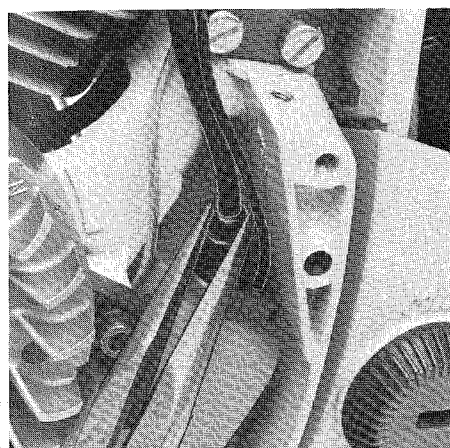

The installation of a new ignition lead is made easier if the ignition armature (module) is unscrewed. The new ignition lead has a length of 150 mm. Fit rubber boot over one end of the lead and screw lead firmly onto the wood screw in the armature (module). It is advisable to make a hole in the center of the ignition lead's cross-section with a pointed tool to ease assembly. Refit ignition armature (module) and set the edge gap (4.4.6). Coat the other end of

Ignition lead positioned in guide

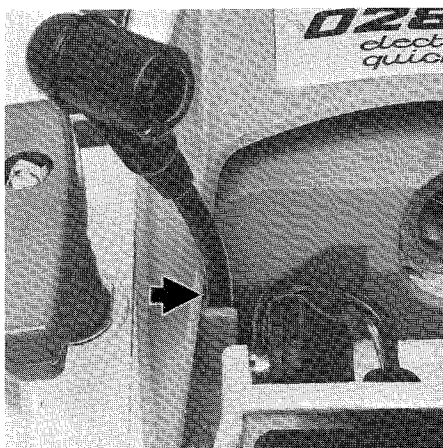

the lead with a little oil and then fit it in the ignition lead terminal. Grip end of the lead with a suitable pair of pliers and pull it forwards out of the terminal. Pinch the hook of the leg spring into the center of the lead's cross-section about 15 mm from the end of the lead. Pull lead back so that leg spring locates in the terminal.

Refit shroud, fan housing and spark plug; fit terminal on the spark plug and mount the carburetor box cover.

On the SEM ignition system the short-circuit wire is permanently connected to the ignition module. However, on Bosch ignition systems it is combined in a single terminal with the primary connection of the armature and connected to the contact set (breaker-controlled) or the switch unit (transistor-controlled). The free end has a contact sleeve which is inserted in the switch cam of the switch spindle.

The short-circuit wire is used to connect the voltage pulse from the trigger coil (SEM) to ground when the short-circuit contact is closed or ground the primary circuit (Bosch) permanently when the engine is switched off.

The contact spring of the short-circuit contact does not have a positive ground connection to the ignition armature (module) because of its position in the AV-insulated tank housing. For this reason a connecting wire (ground wire) is necessary from the short-circuit contact to ground.

If the insulation of the short-circuit wire is damaged, a short-circuit to ground may occur at the point of damage and thus cause the ignition to operate erratically or fail completely. As the short-circuit wire cannot be replaced as a unit, the defective insulation must be renewed in such a case.

4.4.4 Short-Circuit Contact

Securing the ground wire

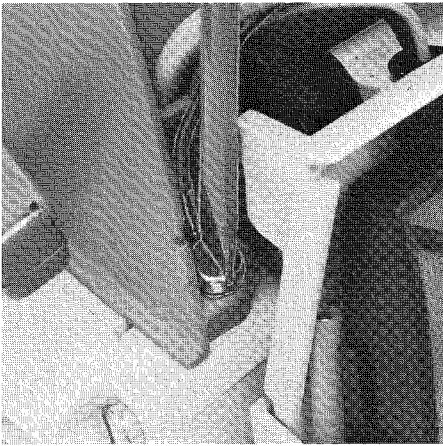

The ground wire need only be replaced if it is broken. To do this, remove carburetor box cover and air filter and the shroud mounting screw which secures the ground wire. Then unscrew contact spring and pull wire out of rubber grommet. Insert new ground wire, 4 mm terminal first, through the rubber grommet. This operation is made easier if the short-circuit wire is first withdrawn and refitted after the ground wire has been threaded through. Then secure ground wire together with shroud and contact spring.

Refit air filter and carburetor box cover.

Contact sleeve in switch cam

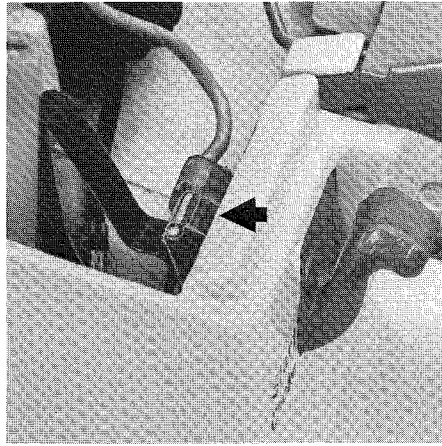

The master control switch (7.1) is used to make the short-circuit connection when the engine is stopped. The switch element on the switch spindle, in which the contact sleeve of the short-circuit wire sits, makes the connection between the ground wire and short-circuit wire via the contact spring in the "Stop" position.

The short-circuit mechanism is in good condition when the contact spring locates against the contact sleeve with the master control lever in the "Stop" position. The contact spring must be replaced if it is distorted or broken.

To do this, first remove carburetor box cover and move master control to "Choke" position.

Unscrew the M 4 x 10 cheese-head screw which holds the contact spring. When fitting the new contact spring, first insert screw through

Top:
Master control in "Choke" position

Bottom:
Securing ground wire and contact spring

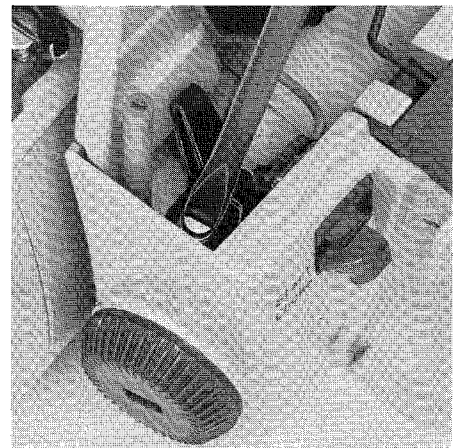
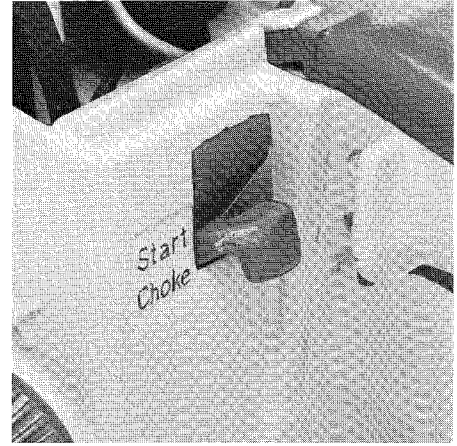

terminal of ground wire and then position and tighten down the contact spring.

Finally check for correct operation and then refit carburetor box cover.

4.4.5 Flywheel

The flywheel performs several functions simultaneously. It accommodates the permanent magnet for the ignition system with a north and a south pole (sequence of polarization in engine's normal direction of rotation). Its front side is designed as a fan wheel to provide the necessary air for engine cooling. A flanged hub, also on the front side, incorporates six pawl notches for transmission of starting torque. One of the most important functions of this relatively large flywheel mass is to substantially smooth out the irregularities of the engine.

The flywheel is mounted at the ignition side of the crankshaft on a taper seat and is located by means of a key and secured with a hexagon nut.

To disassemble the flywheel, first remove the fan housing, unscrew the spark plug and fit locking screw 1107 191 1200 in the spark plug hole and tighten down by hand.

Rotate crankshaft counter-clockwise until piston crown locates against the locking screw. Use a ring or socket wrench to slacken off and remove the hexagon nut counter-clockwise.

Screw flywheel puller 1110 890 4500 as far as it will go into the thread of the flywheel hub. Hold puller with a 24 mm open end or ring wrench and tighten down thrust bolt with a 19 mm

Top:
Releasing hexagon nut

Bottom:
Special puller 1110 890 4500

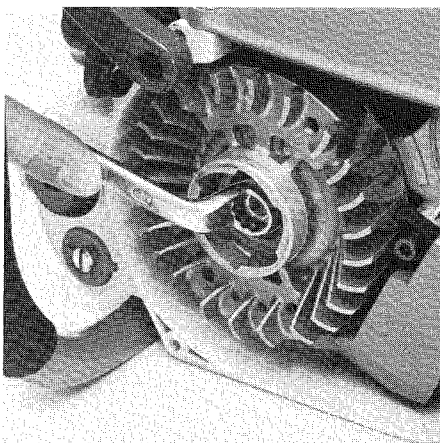

wrench until the flywheel hub is released from the taper seat on the crankshaft.

The flywheel will come away from its seat more easily if the puller is tapped with a hammer after tightening the thrust bolt.

Always replace a damaged flywheel (cracks, broken fan blades, etc).

Top:
Puller in position

Bottom:
Pulling off flywheel

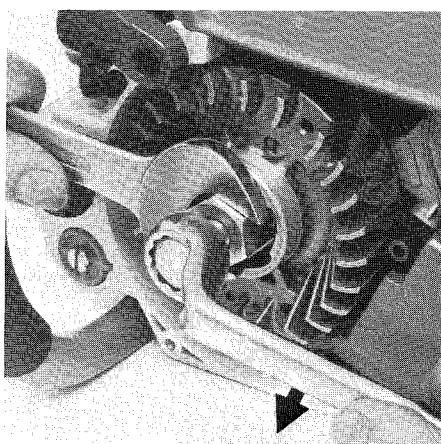
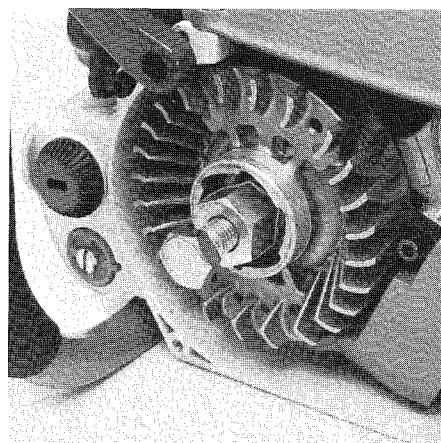

Key in position

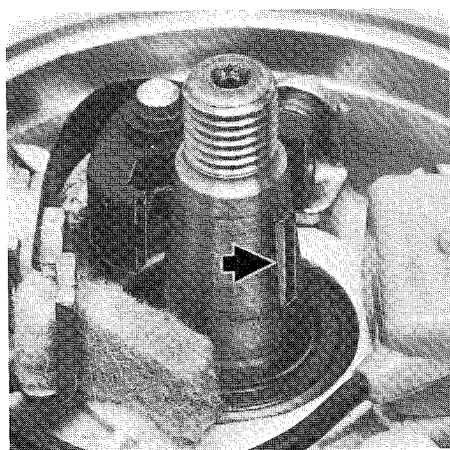

Before re-installing the flywheel clean the crankshaft taper and flywheel hub bore with a suitable degreasing agent (e.g. trichlorethylene, diluted nitro).

Make sure that key is properly located.

Note the following when mounting the flywheel:

The ignition process is triggered at different magnet positions according to the type of ignition system (Bosch or SEM). To insure that the replacement flywheel can be used for both types of ignition system, two key slots are machined in the flywheel hub. The standard flywheel for SEM ignition systems also has two slots. The positions of the slots can be seen in the above illustration.

The standard flywheel for Bosch ignition systems has only one key slot and can, therefore, only be used

Top:
Key slots
B = Bosch
S = SEM

Bottom:
Tightening hexagon nut with torque wrench

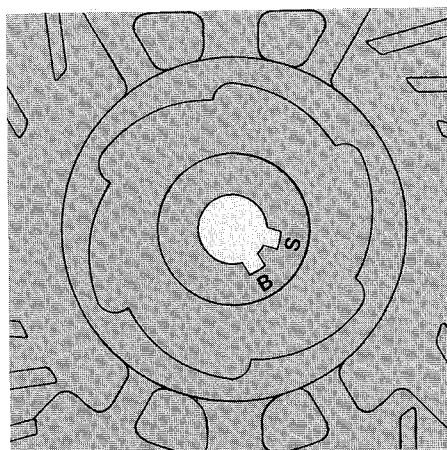

Flywheel for saws with handle heating system

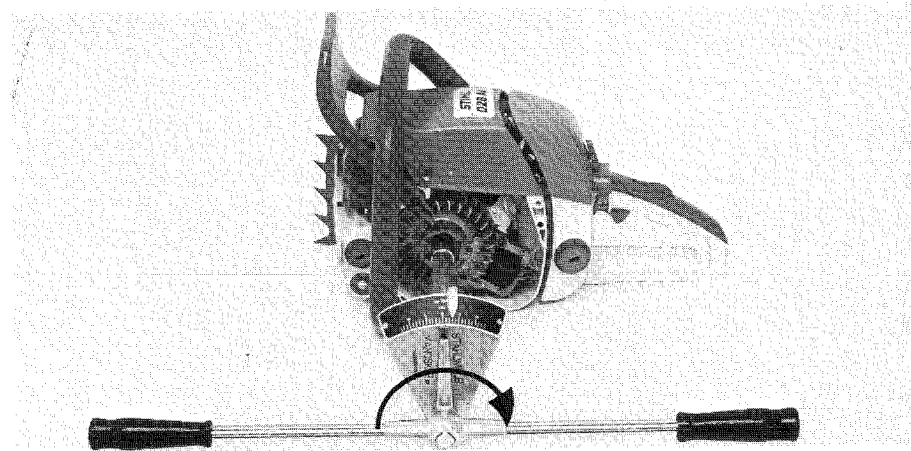
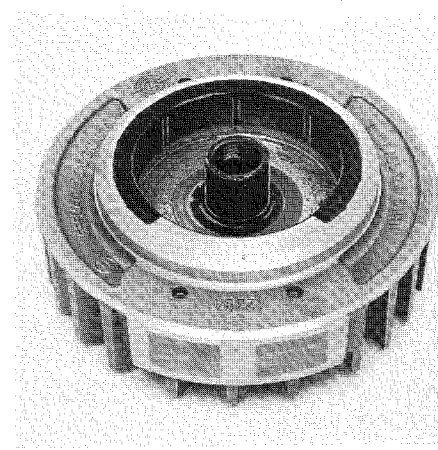

for these ignition systems (breaker-less and breaker-controlled).

Fit flywheel on the crankshaft so that the correct slot fits over the key. Screw hexagon nut onto flywheel and tighten down.

In order not to overload the key it is important that all forces generated by the flywheel are transmitted via the taper seat between the flywheel and crankshaft. For this reason it is

essential to insure that the crankshaft nut is tightened down to the specified torque of 29.4 Nm (3.0 kpm).

Finish off by removing locking screw, refitting spark plug, fan housing and carburetor box cover.

4.4.6 Ignition Module (SEM) Ignition Armature (Bosch)

The charging coil, storage capacitor, trigger coil, electronic switch unit and ignition transformer are combined to form a single unit in the **ignition module (SEM)**. The four coils are arranged on the three arms of the common iron core. All parts are completely encased in plastic material to protect them against moisture; only two electrical connections emerge from the ignition module – the high-tension output and the short-circuit wire. In the event of a fault in any of the integrated elements, the whole ignition module must be replaced.

On the **ignition armature (Bosch)** the primary and secondary coils are mounted on the center arm of the iron core and encased in plastic material to protect them against moisture. Three electrical connections emerge from the coil body, i.e. the primary connection, secondary connection and common ground connection, which is riveted to the core.

There are two ways of testing the Bosch ignition armature:

An ohmmeter 5910 850 4800 can be used to check the resistance of both coil windings.

However, accurate testing is only possible with an ignition coil tester.

4.4.6.1 Resistance Test on Primary Winding

Top:
Test lead on primary connection

Bottom:
Resistance test on primary
winding

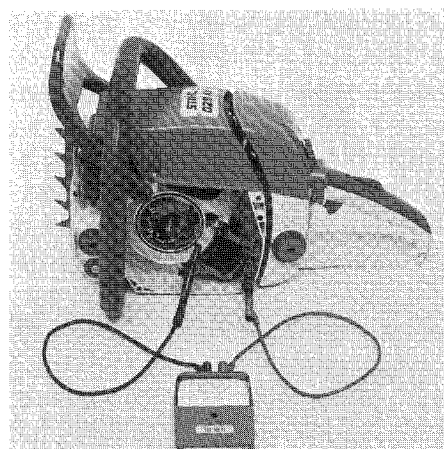
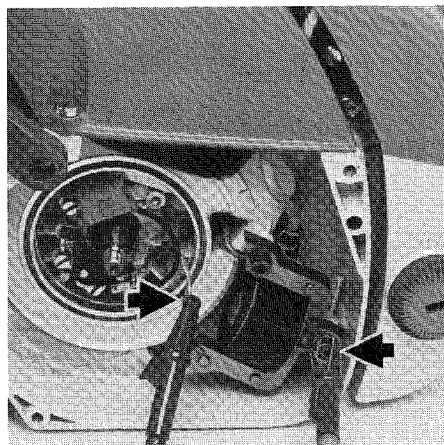

To test the primary winding, first remove the flywheel (4.4.5) and disconnect wire from contact set or switch unit. Connect one of the two test leads to the primary connection and the other to ground of ignition armature. In measuring range " $\Omega \times 1$ " the ohmmeter should indicate a value of 0.7 – 1.0 (Ω).

If different values are obtained the ignition armature must be renewed.

4.4.6.2 Resistance Test on Secondary Winding

Top:
Test lead attached to spark plug terminal

Bottom:
Resistance test on secondary
winding

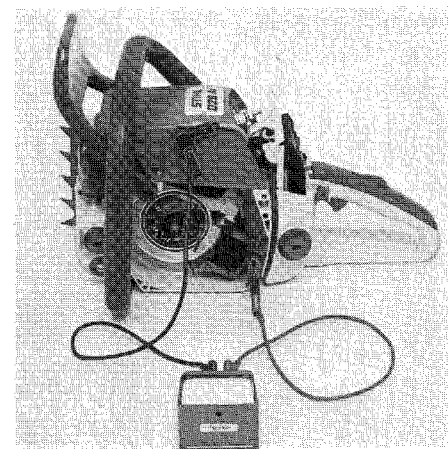
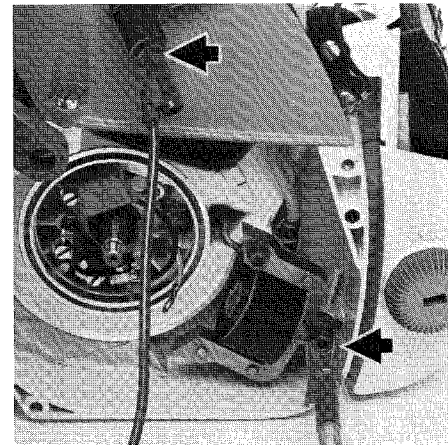

To check the secondary winding, connect banana pin of one test lead to leg spring in spark plug terminal and the other test lead to ground of ignition armature. In measuring range " $\Omega \times 1000$ " ($k\Omega$), the ohmmeter should now indicate a value of 7.7 – 10.3 ($k\Omega$). If different values are obtained, the ignition armature must be replaced.

4.4.6.3 Testing with Ignition Coil Tester

Armature test with ignition coil tester

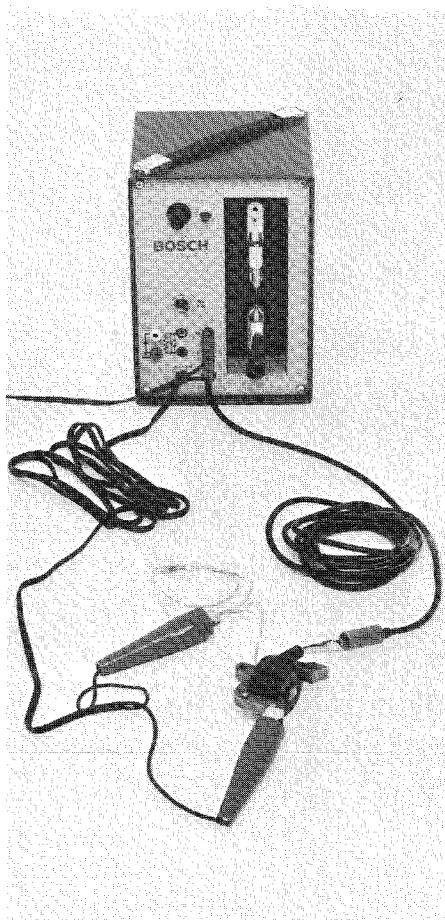

The sparkover can be checked with an ignition coil tester, e.g. Bosch, EFMZ 1 A, or EFAW 106 A. The armature must be removed for this purpose.

A spark length of 7 mm at 2.4 A must be obtained in this test.

4.4.6.4 Removal and Installation

Rubber grommet in position

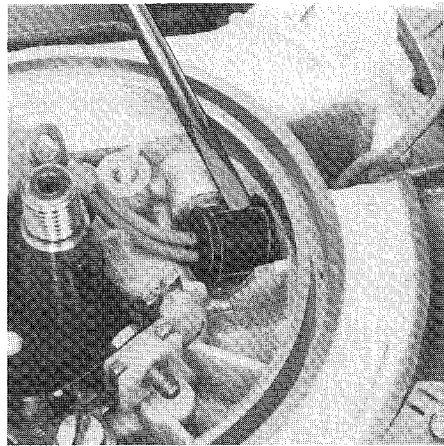

Before disassembling, remove the fan housing, carburetor box cover, shroud and air filter. Then pull short-circuit wire out of switch cam on switch spindle and out of the rubber grommet. In case of Bosch ignition systems, the flywheel must also be removed, the common terminal of the short-circuit wire and primary wire unscrewed from the contact set or switch unit, and both wires pulled out of the housing bore together with the rubber grommet. Slacken off and remove the cheese-head screws which secure the ignition armature (module).

Remove spark plug terminal from defective ignition armature (module) and transfer it to the new one.

On Bosch ignition systems, fit the terminal with primary and short-circuit wires through the housing bore, push on the rubber grommet and insert it in the bore. Secure terminal to contact set or switch unit.

Top:
Securing the wire terminal

Center:
Wire routed through recess

Bottom:
Flywheel aligned

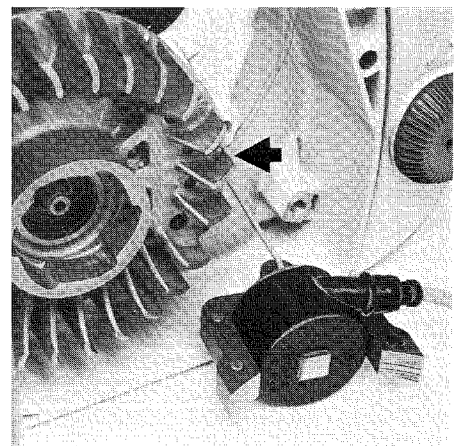
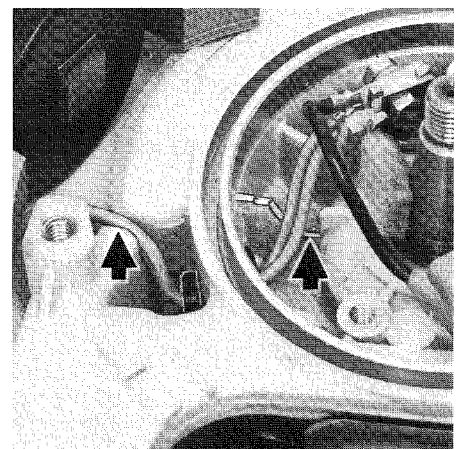
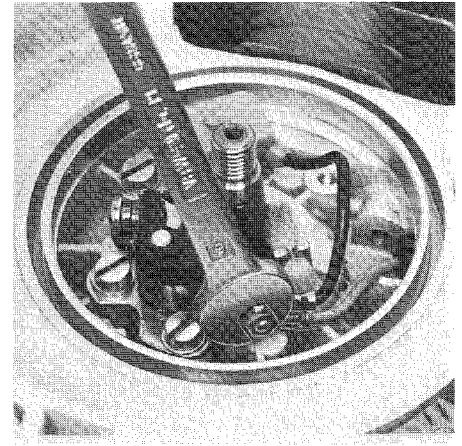

4.4.7 Condenser (Bosch breaker-controlled ignition only)

Top:
Special setting gauge
1111 890 6400

Bottom:
Securing the ignition module

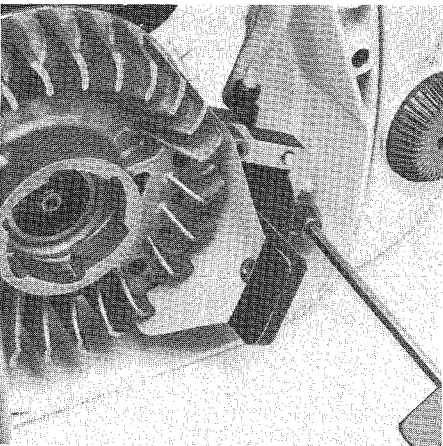
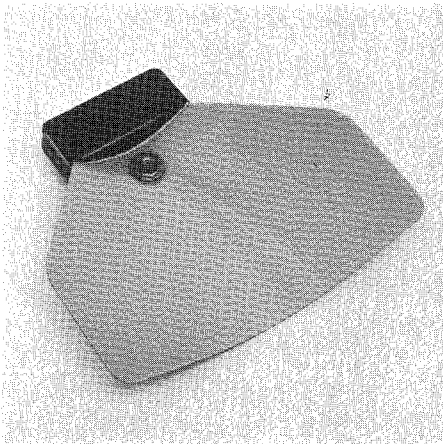

Now fit flywheel and turn it so that the magnet poles are pointing towards the pistol grip. Position ignition armature (module) in crankcase. Insert screws and tighten down provisionally. Now align flywheel so that the area in which the magnets are embedded covers half of the two outside armature arms. Insert setting gauge or 0.2 mm gauge sheet between magnet poles and armature arms, press ignition armature (module) firmly against

Checking air gap with feeler gauge

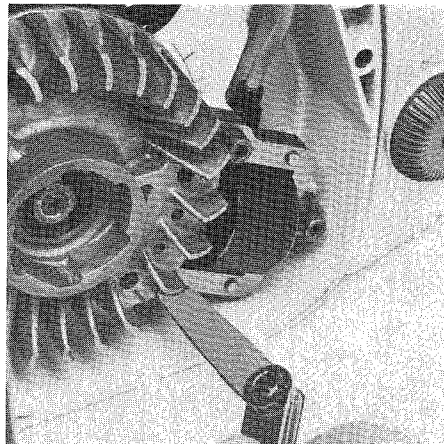

the flywheel and tighten down the screws, starting with the screw which passes through the center armature arm.

Withdraw gauge sheet and check the air gap with a feeler gauge. The specified air gap is 0.2 – 0.3 mm.

Fit short-circuit wire through the rubber grommet in the tank housing and insert it in the switch cam. Refit fan housing, air filter, shroud and carburetor box cover.

The condenser is wired in parallel with the contact breaker. While the points are opening the primary current is fed briefly to the condenser until it is charged. This insures that the strength of the current flowing via the contact breaker at this point is only very low and thus suppresses excessive sparking (arcing).

A faulty condenser is often the cause for premature pitting of breaker points and loss of ignition voltage. The condenser's capacitance is 0.15 ... 0.19 μF and can be checked with the ohmmeter 5910 850 4800 or the Bosch ignition coil and condenser tester EFAW 106 A. To do this, remove the fan housing and flywheel and disconnect the condenser wire from the contact set.

To check with the ohmmeter, connect one of the two test leads to ground (e.g. cylinder fin) and the other to the condenser connection. If the condenser is in good condition, it will be charged and the ohmmeter's pointer should briefly move to about 0.2 (μF) in the measuring range " $\mu \times 1$ " (μ = microfarad). If this is not the case, fit a new condenser.

4.4.8 Contact Set (Bosch breaker-controlled ignitions only)

Top:
Checking condenser with ohmmeter

Bottom:
Discharging the condenser

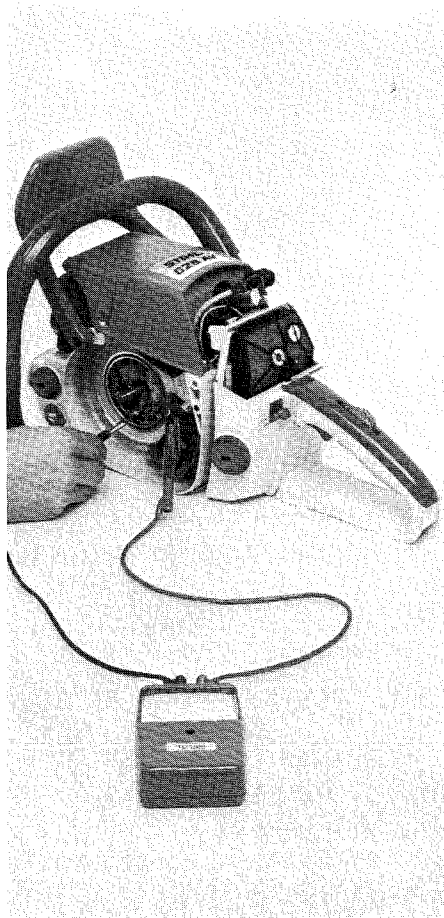

Locating stud on condenser

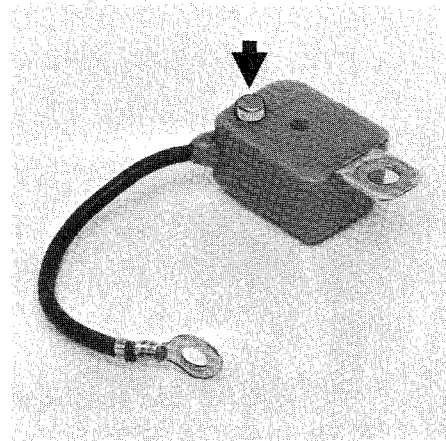

The condenser must be discharged after this test by shorting the wire terminal to ground.

If the Bosch tester EFAW 106 A is used for this test, follow the instructions supplied with the unit.

When changing the condenser, make sure that the locating stud on the condenser is fitted in the hole in the crankcase. Tighten down the mounting screw securely. Connect condenser wire to contact set and tighten down the terminal screw.

Finish off by refitting flywheel and fan housing.

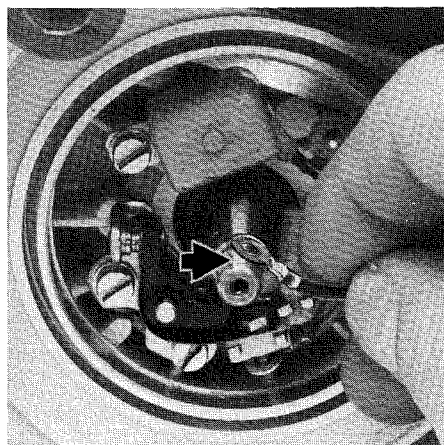

The contact breaker set consists of a fixed contact – connected to ground – and a moving contact breaker lever which is insulated from ground and connected to the primary connection of the ignition coil, the condenser and the short-circuit contact. The contact set operates as a switch which closes the primary circuit and opens it again at the point of ignition.

The heel of the contact breaker lever is pressed against the eccentric hub of the flywheel by a spring and is actuated by the cam lobe on the hub.

The service life of the heel on the contact breaker lever is greatly dependent on proper lubrication. It is, therefore, important to insure that the grease impregnated lubricating felt in the contact plate is always in good condition and the groove behind the heel packed with ample grease.

The contact breaker points wear as a result of erosion (burning). Burnt contacts increase the breaker point gap and thus "advance" ignition timing and reduce the magneto edge gap.

Top:
Unscrewing contact set

Bottom:
Locating stud on contact set

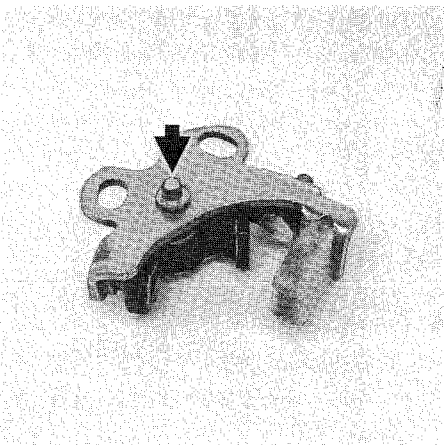
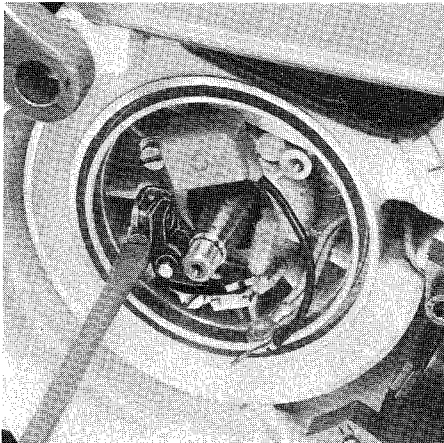

Partly burnt contacts can be reset, while severely burnt contacts necessitate immediate renewal of the complete contact set. To do this, remove fan housing and flywheel, disconnect wires from terminal and unscrew contact set mounting screws.

Fit new contact set (note locating stud), reconnect wires and adjust contact breaker gap. Push special adjusting cam 1118 893 0500 onto

Top:
Special adjusting cam
1118 893 0500

Bottom:
Adjusting cam fitted on crankshaft

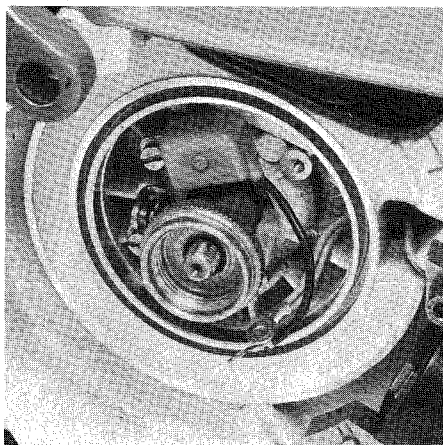
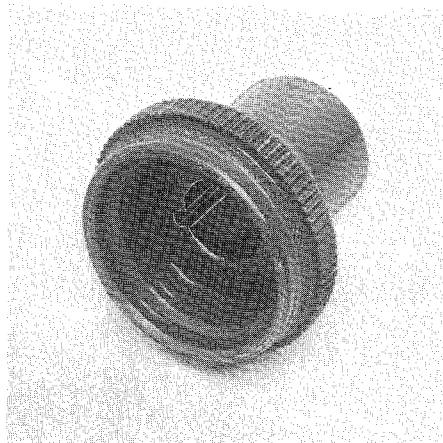

crankshaft. Unscrew locking screw and turn crankshaft to T.D.C. position. The flywheel cam opens the contact breaker lever fully in this position. Now slacken off contact set and turn it until a breaker point gap of 0.35 – 0.4 mm is obtained with a **clean** feeler gauge. Retighten the mounting screws and check ignition timing and magneto edge gap.

The contact breaker point gap, igni-

Checking breaker point gap

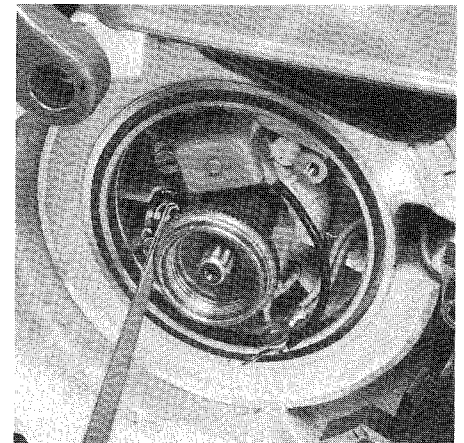

tion timing and magneto edge gap are inter-related and neither of these values can be altered without influencing the other. This also means that if one of these is correctly set, the others should also be correct. The dominating factor is the magneto edge gap. If variations are experienced in practice, preference should be given to maintaining the edge gap.

Finally, fill the groove of the contact breaker lever with the grease supplied with the new contact set and then reassemble the other parts.

4.4.9 Switch Unit (Bosch transistor-controlled ignitions only)

4.5 Ignition timing

Removing the switch unit

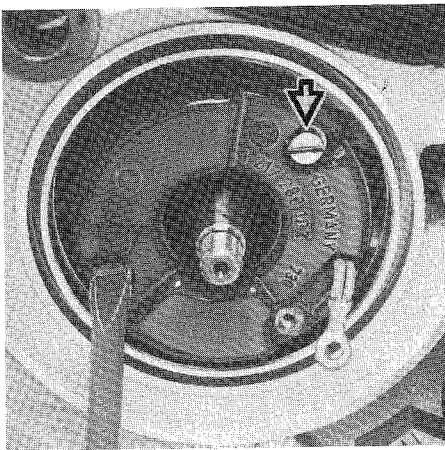

The electronic switch elements and other components of the electronic control are combined on a single printed circuit board in the switch unit and encased in plastic material. The electronic control is, therefore, impervious to moisture and dirt.

The switch unit is not subject to mechanical wear and is substantially trouble-free in operation. As long as the switch unit is intact, the ignition point remains constant and does not, therefore, require checking.

However, it can be assumed that the switch unit is faulty and needs to be replaced if the spark test on the ignition system is negative, although the other components are in order.

To disassemble the switch unit, first remove the fan housing and flywheel and disconnect the terminal of the primary and short-circuit wires.

Elastosil on terminal screw

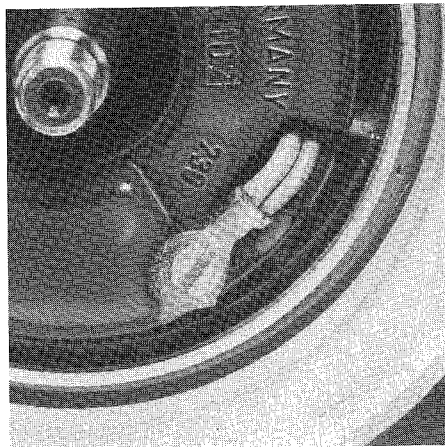

Unscrew the switch unit mounting screws and lift out the unit. Reverse the sequence to fit the new unit, making sure that the primary and short-circuit wires locate in the recess in the crankcase. In order to increase operational reliability under damp conditions, it is advisable to cover the terminal screw with Elastosil, part no. 0783 820 0110. Refit flywheel (pay attention to correct key slot) and fan housing.

Finish off by repeating spark test.

The ignition timing on the breaker-controlled magneto ignition system must be set to 2.1 – 2.3 mm before T.D.C. (top dead center). This means that the moving contact should just begin to lift off the fixed contact when the crankshaft is in this position. The contact breaker points should be fully open when the crankshaft is in the T.D.C. position and the gap must be 0.35 – 0.40 mm (only measure with adjusting cam – see 4.4.8).

On both types of electronic (breakerless) ignition systems the ignition timing is fixed at 2.6 mm before T.D.C. at 8000 rpm and is not adjustable. However, in view of the permissible tolerance in the electronic circuit, it may vary between 2.4 and 2.8 mm before T.D.C. at 8000 rpm. As there is no mechanical wear on these systems, the ignition timing cannot get out of adjustment during operation. However, an internal fault in the circuit can alter the switching point to such an extent that the spark test will still be positive, although ignition is outside the permissible tolerance and thus impair engine starting and power delivery.

4.5.1. Checking Timing on Breaker-controlled Ignition (Bosch)

Timing marks on the flywheel and crankcase

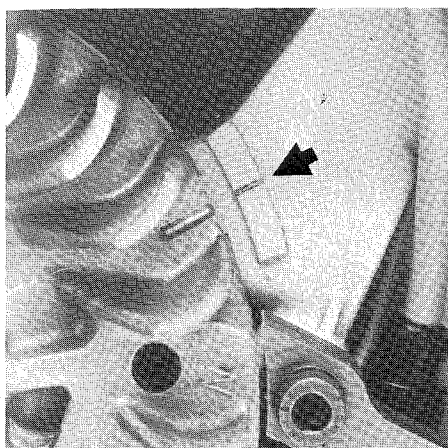

To check ignition timing, first remove the carburetor box cover, air filter and fan housing and unscrew the spark plug (to ease rotation of flywheel). Now pull contact sleeve of short-circuit wire out of the switch cam and connect one terminal clip of the ignition timing unit to the contact sleeve and the other to ground.

Switch on the ignition timing unit and turn flywheel slowly in the engine's normal direction of rotation (counter-clockwise) until the indicator lamp on the timing unit lights up. The contact breaker opens in this position. The timing marks on the flywheel and crankcase should be exactly in alignment. If this is not the case, the ignition must be retimed.

4.5.2 Adjusting Timing on Breaker-controlled Ignition (Bosch)

Special clamp 5910850 5700

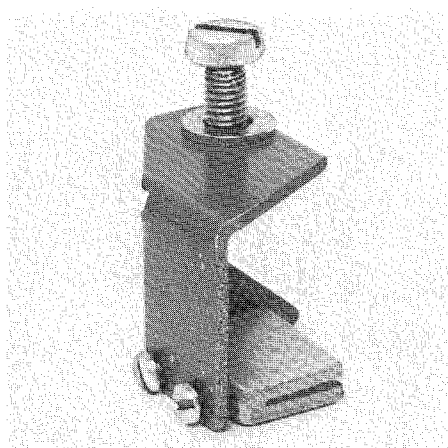

Remove the shroud and flywheel (4.4.5) in addition to the preparatory work described under 4.5.1. As the flywheel is a completed solid unit, the special adjusting cam 1118893 0500 must be used for this adjustment. The hub of an old flywheel for Bosch ignition systems would also be suitable for this purpose.

Now mount ignition timing unit and clamp on the cylinder.

To do this, back off the screws in the clamp plate until they can be pushed between the second and third cylinder fins (from the top). Align the clamp so that it is flush with the edges of the cylinder fins and then moderately tighten the self-tapping screws. This opens up the plate between the cylinder fins and secures the clamp.

Fit dial gauge in seat of holder (curved side facing downwards) and **moderately** tighten the cheese-

Top:
securing the clamp

Bottom:
Holder and dial gauge in position

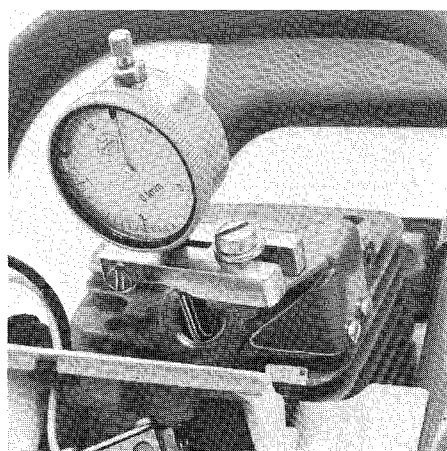
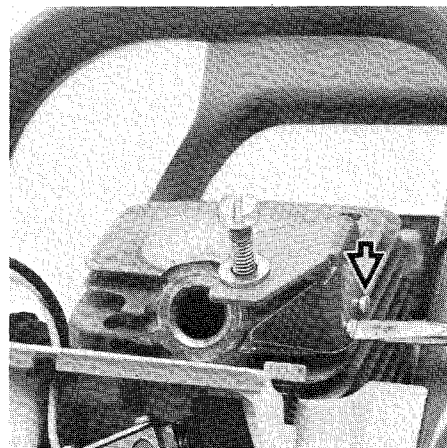

head screw. The lower edge to the clamping collar on the dial gauge should be flush with the lower edge of the holder.

Caution: If the screw is over-tightened, the clamping collar – which is also the spindle guide – will be deformed and the measuring spindle will jam.

Dial gauge set to "0"

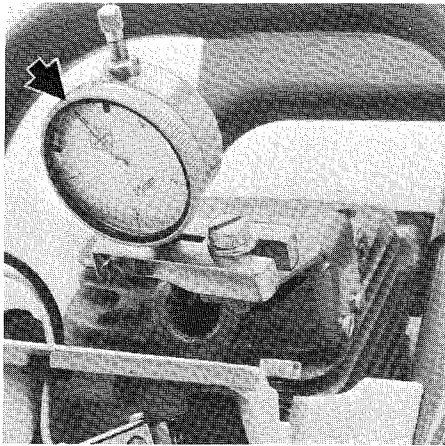

Fit S-shaped tracer pin 1106894 3000 in measuring spindle in place of the ball-pointed tracer pin. Now fit dial gauge with holder on the clamp so that tracer pin extends into the cylinder. Align holder and tracer pin so that the pin is concentric with the spark plug hole, engages in the center of the cylinder bore and does not foul anything. Tighten down the holder with the cheese-head screw.

Now push adjusting cam firmly onto the crankshaft and bring piston exactly into T.D.C. position by turning crankshaft backwards and forwards. Set dial gauge to "0" by adjusting the bezel. Turn crankshaft beyond T.D.C. until the dial gauge indicates a mean value of 2.2 mm. Switch on the ignition timing unit, slacken the contact set and turn it so that the indicator lamp on the timing unit just lights up.

Then retighten contact set mounting screws and check ignition timing. If

Top:
Ignition timing unit connected up

Bottom:
Turning the contact set

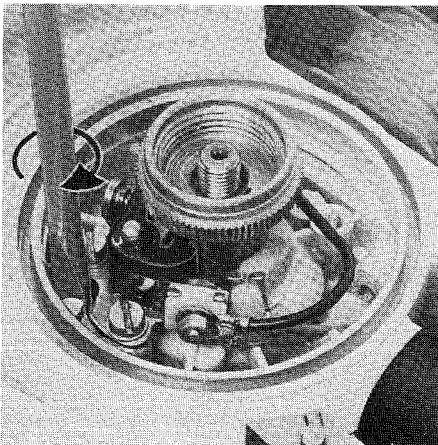
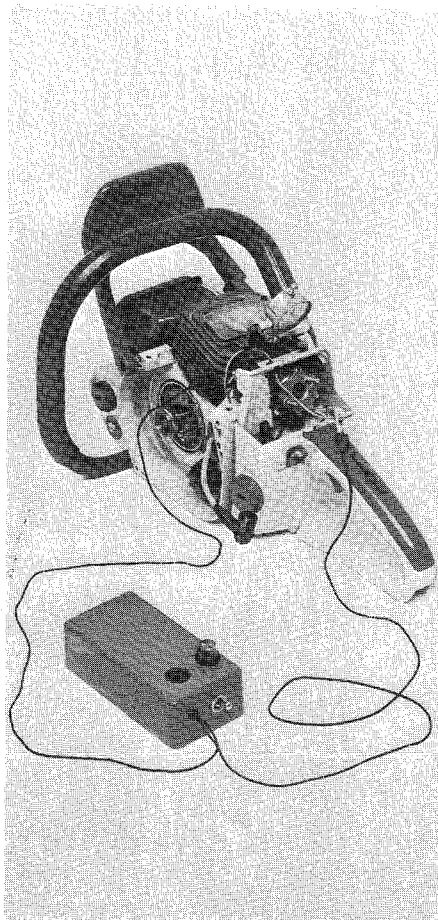

it is now between 2.1 and 2.3 mm before T.D.C., the contact breaker gap should be between 0.35 and 0.40 mm, and the magneto edge gap (4.6) between 4 and 8 mm.

The contact breaker gap, ignition timing and magneto edge gap are inter-related. Neither of these values can be changed without influencing the other. However, this also means that if one of these values is correctly set the others will normally be correct. The dominating factor is the magneto edge gap. If any variations are experienced in practice, preference should be given to maintaining the edge gap.

Finish off by removing the test equipment and refitting the flywheel, fan housing, shroud, spark plug, air filter and carburetor box cover.

4.5.3 Checking Timing on Breakerless Ignition Systems (Bosch and SEM)

Timing marks applied

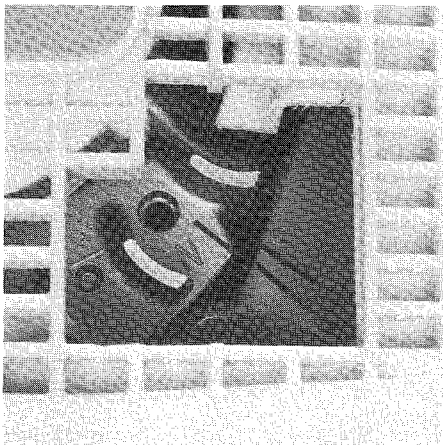

Contrary to the breaker-controlled ignitions, the ignition timing on the breakerless ignitions cannot be checked statically, i.e. it must be checked with the engine running using a stroboscopic timing light. The Bosch stroboscope ET Z 003 (Bosch order number 0684100300) which is accurate up to 10000 rpm is particularly suitable for this purpose. The Bosch timing light EFAW 180 (Bosch order number 0681101103) and EFAW 185 (Bosch order number 0681101102), which are accurate up to 6000 rpm, can also be used.

The preparatory work is the same here as under 4.5.2 but the flywheel remains on the crankshaft. Now move the crankshaft to the T.D.C. position and set the dial gauge to "0". Turn crankshaft backwards (clockwise) until the dial gauge indicates a value of 2.4 mm. Use a suit-

Top:
Fan housing with special opening

Bottom:
Checking engine speed

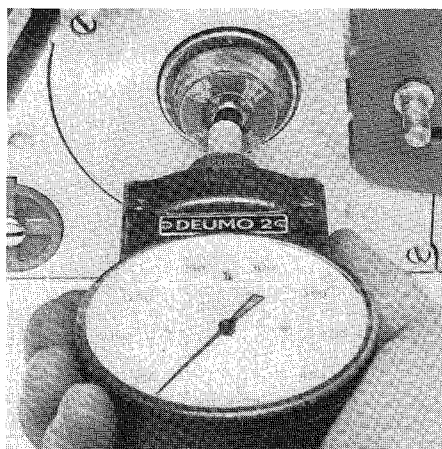
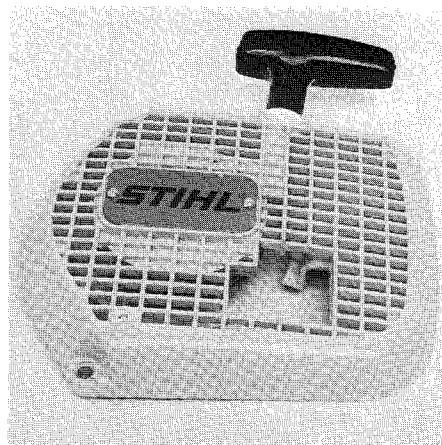

able felt pen to apply timing marks to the flywheel and armature arm. Then turn flywheel until the dial gauge shows a value of 2.8 and apply a second timing mark to the armature arm in line with the one on the flywheel.

The dial gauge and clamp must now be removed before the engine can be started. Insert short-circuit wire in switch cam and refit air filter,

shroud and spark plug. Connect up test lead as described in the timing light's operating instructions.

A specially made up fan housing must be used for the test procedure so that the timing marks can be seen when the rewind starter is fitted. As can be seen in the illustration, an opening is made in the lower right-hand half of the housing.

Because of the need for proper cooling, the fan housing must not be fitted without the deflector segment. A suitable opening must therefore be made in the segment as well.

With the test set up in this way, start the engine and set the speed to 8000 rpm with a tachometer. After briefly warming up the engine (approx. 1 minute), direct the timing light through the opening in the fan housing at the timing marks. If the electronic control is intact, the mark on the flywheel should appear to be in line with one of the two marks on the armature or between them. If the mark is outside this area, the electronic control is faulty. In this case the switch unit must be replaced on the Bosch ignition system, or the ignition module on the SEM system.

4.6 Magneto Edge Gap (Bosch Breaker-controlled Ignition Only)

Flash directed at timing marks



Repeat test procedure, remove test equipment and reassemble the machine.

Edge gap

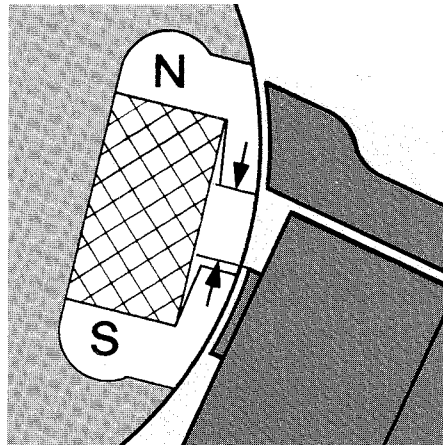

The position of the magnet at the point of current interruption, i.e. ignition, is defined as the edge gap. The edge gap is, therefore, the distance between the trailing edge of the north pole shoe and the left-hand edge of the center armature arm when the contact breaker points begin to open. This distance is 4 to 8 mm on the Bosch breaker-controlled ignition system.

The magneto edge gap has a decisive influence on the performance of the ignition system. If it is too large, the ignition voltage during starting will be too low; however, if it is too small, the engine will misfire at high speed.

If the ignition is properly timed, the magneto edge gap will also be correct. However, variations can occur because of the accumulation of tolerances. The edge gap should, therefore, also be checked whenever the ignition timing is altered.

Preference should always be given to maintaining the correct edge gap rather than accurate ignition timing and contact breaker gap.

To check the edge gap, first follow description for checking the ignition timing on breaker-controlled ignition systems (4.5.1). The edge gap should then be measured at the moment the indicator lamp on the ignition timing unit lights up (ignition point).

5. REWIND STARTER

5.1 Construction and Operation

The rewind starter is mounted on the starter post in the fan housing, directly in front of the flywheel. The main components of this newly developed single pawl starter unit are the starter rope with grip, rope rotor, pawl, spring clip and rewind spring.

The starter rope, which is wound onto the rope rotor by the preload of the rewind spring, rotates the rotor when the starter grip is pulled. This

causes the spring clip to turn relative to the rope rotor, the pawl moves into the upright position and engages in one of the six notches in the flywheel hub. The torque produced by the starter rope is thus transmitted positively via the flywheel and sets the crankshaft in motion.

The withdrawn starter rope is automatically rewound onto the rope

rotor by the tensioned rewind spring and the pawl returns to its idle position.

The rewind starter itself is practically maintenance-free. Only the bearing bush of the rope rotor needs to be lubricated with resin-free oil at regular intervals.

5.2 Troubleshooting Chart

Fault	Cause	Remedy
Starter rope broken	Rope pulled out too vigorously as far as stop or over the edge, i.e. not vertically	Replace starter rope
Rewind spring broken	Spring over-tensioned – no reserve when starter rope is fully extended	Replace rewind spring
Starter rope can be pulled out almost without resistance (crankshaft does not turn)	Guide pin on pawl or pawl itself worn	Renew pawl
	Spring clip fatigued	Replace spring clip
Starter rope is difficult to pull and rewinds very slowly	Rewind starter dirty (dusty conditions)	Thoroughly clean rewind starter
	The lubricating oil on the rewind spring becomes viscous at very low outside temperatures (spring windings stick together)	Apply a little paraffin to the rewind spring, then pull starter rope carefully several times until it operates properly

5.3 Disassembly

Top:
Unscrewing fan housing

Bottom:
Withdrawing the starter rope

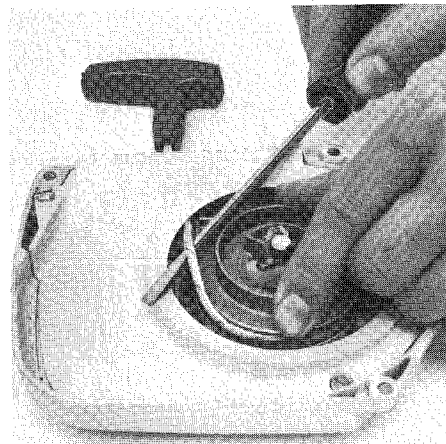
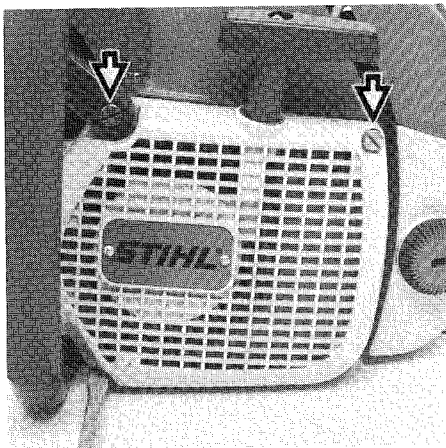

First unscrew fan housing and then release tension on rewind spring. To do this, pull starter rope partly out of housing and unwind two to three turns of the starter rope while holding the rope rotor firmly. Release the rope rotor – the rewind spring is now relieved of preload.

There will, of course, be no preload on the rewind spring if the starter rope was broken. Use a screwdriver or a suitable pair of pliers to care-

Top:
Removing spring clip

Bottom:
Component parts of rewind starter

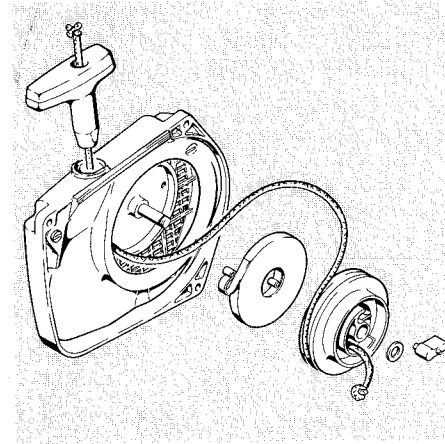
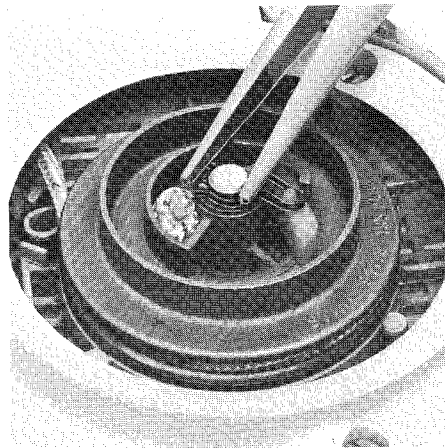

fully remove the spring clip from the starter post. The washer and rope rotor can now be taken off the starter post.

5.4 Installation of Starter Rope

Top:
Starter rope secured in rope rotor

Bottom:
Special knots used

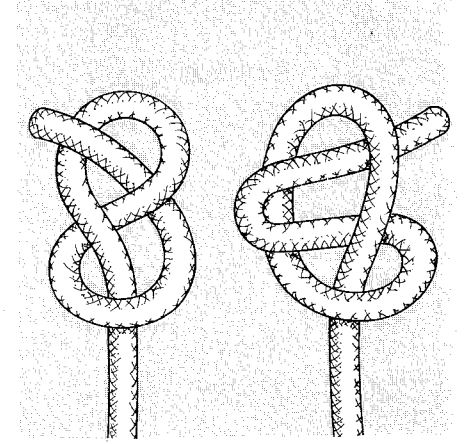
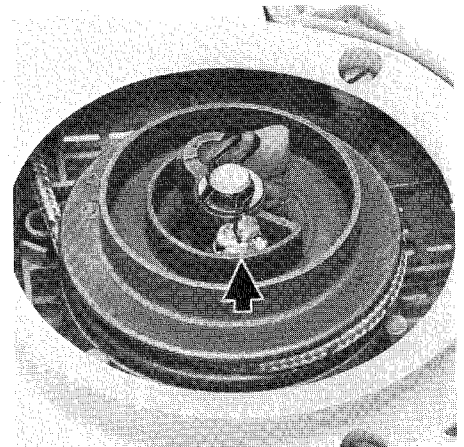

Remove rope residue from the rope rotor, thread a new 3.5 mm dia. and 1060 mm long starter rope through the rope rotor and secure with a simple knot. Push the other end of the rope through the rope bush in the fan housing and secure it in the starter grip with a double-knot.

Do not wind rope onto rope rotor. Lubricate bush of rope rotor and annular groove in starter post with a little resin-free oil.

5.5 Replacing the Rewind Spring

5.6 Tensioning the Rewind Spring

Fitting spring clip

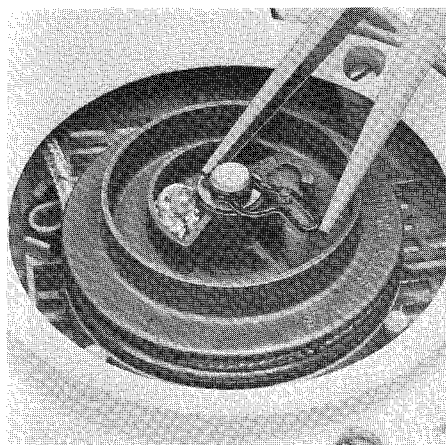

Push rope rotor onto starter post and turn backwards and forwards until the inner loop of the rewind spring engages in the recess on the annular rib. Now insert pawl in rope rotor, place washer on the starter post and use a screwdriver or a suitable pair of pliers to fit spring clip. Make sure that spring clip engages on guide pin of pawl and faces in the clockwise direction. Always take great care with the spring clip to ensure that it is not bent during disassembly and reassembly, as this would cause the rewind starter to malfunction.

Finish off by tensioning the rewind spring.

Rewind spring in position

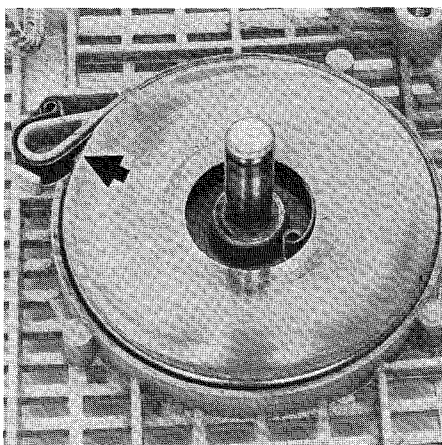

First remove rope rotor and take spring housing with rewind spring and any spring particles out of the fan housing.

Lubricate rewind spring with resin-free oil and fit it together with spring housing (bottom facing upwards) in the fan housing. Hook the outer spring loop over the cast lug on the fan housing.

If the spring jumps out and uncoils during installation, it should be refitted in spring housing in the clockwise direction, starting with the outer loop and working inwards.

Refit the rope rotor.

Winding starter rope onto rotor

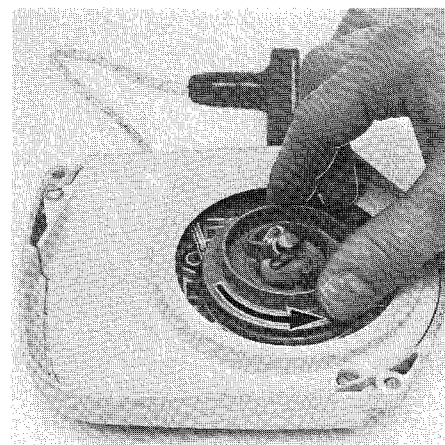

Wind starter rope onto rope rotor counter-clockwise until the starter grip is about 20 cm (8") away from the fan housing. Make a loop with the free end of the rope between the fan housing and the rope rotor and use it to rotate the rope rotor three full turns clockwise. Hold rope rotor firmly and straighten out twisted rope.

Release rope rotor and allow starter rope to rewind slowly onto the rope rotor.

The rewind spring is correctly tensioned when the starter grip sits firmly in the rope bush and does not hang to one side. If this is not the case, tension rewind spring a further turn.

When the rope is fully extended it must be possible to rotate the rope rotor at least another half a turn before maximum spring tension is reached.

5.7 Replacing Starter Rope Guide Bush

5.8 Routine Maintenance

Top:
Withdrawing the starter

Bottom:
Tensioning the rewind spring

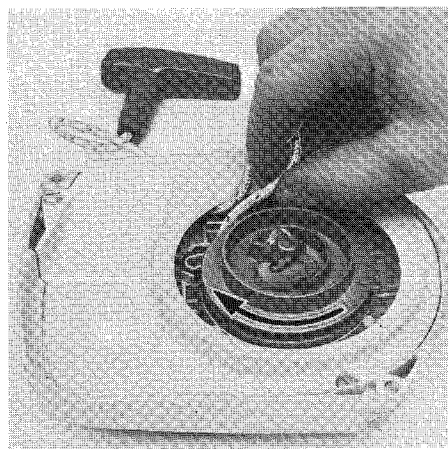
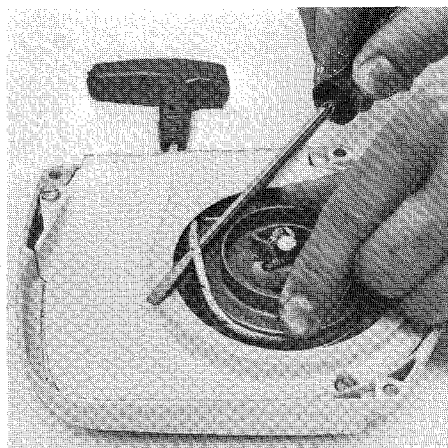

If this is not the case, hold the rope rotor firmly and take off one turn of the rope.

Do not over-tension rewind spring as this will cause it to break prematurely.

Reassemble the fan housing.

Fitting new rope bush

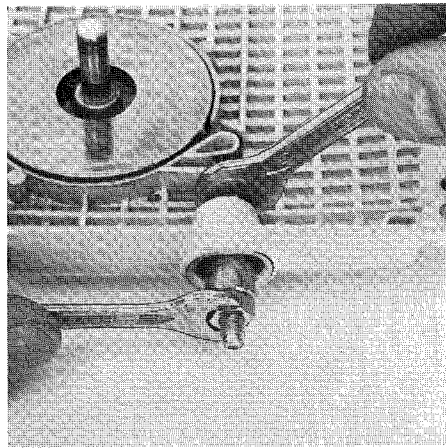

The wear on the bush is increased considerably if the starter rope is pulled sideways during starting. The wall of the bush eventually wears through, becomes loose and must be replaced.

To do this, unscrew deflector segment and pull starter rope out of rope bush. Use a screwdriver to lever the old bush out of the fan housing. Fit new bush in its seat. Insert threaded end of installing tool 0000 890 2201 through the guide bush from the inside of the fan housing and fit the thrust sleeve and hexagon nut. Now tighten down the hexagon nut to fold over the lower end of the rope bush until it is firmly seated.

If starter rope action becomes very stiff and the rope only rewinds very slowly or not completely, it can be assumed that the rewind starter is mechanically in order but plugged with dirt. At very low outside temperatures the oil on the rewind spring may thicken and cause the spring windings to stick together.

This has a detrimental effect on the function of the rewind starter. In such a case it is sufficient to apply a little paraffin to the rewind spring. Then pull out starter rope slowly several times until its normal smooth action is restored.

If clogged with dirt or resin, the entire rewind starter, including rewind spring, must be removed from the machine. Take special care when removing the spring. Wash all parts in paraffin or clean gasoline.

Lubricate rewind spring and post with oil when reassembling.

6. AV HANDLE SYSTEM

6.2 Repair

6.1 Construction and Operation

Location of vibration dampers

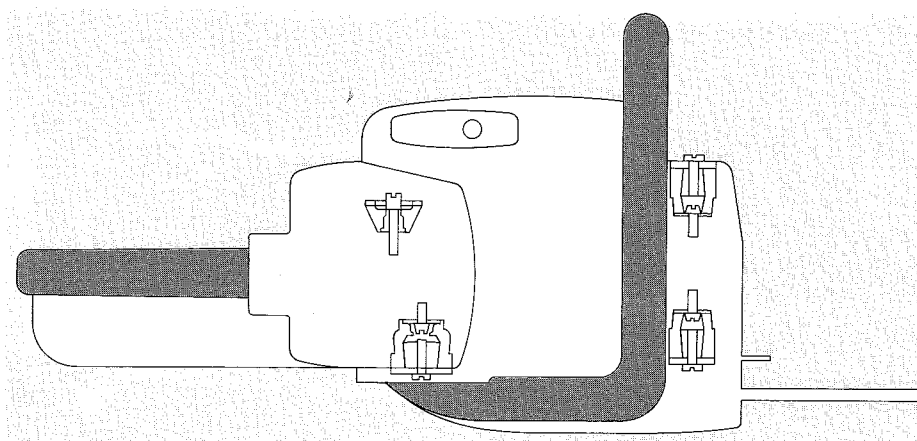

Removing the side plate

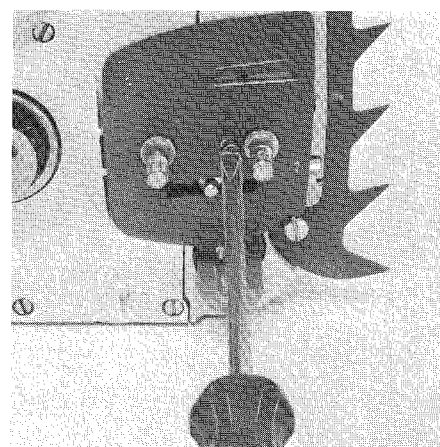

The anti-vibration handle system insures that all vibrations generated by the engine and cutting attachment are damped down to a minimum before reaching the operator. Apart from the engine itself (with rewind starter, ignition system, chain drive and chain brake) all other parts of the machine are connected to the AV system.

Owing to the compact construction of this chain saw – on which the pistol grip, handlebar, carburetor with air filter and fuel tank, are mounted on or in the tank housing – vibration insulation is only required between the crankcase (with chain oil tank) and the tank housing.

At the joints between the crankcase and tank housing there are four vibration dampers located as follows:

Two vibration dampers are fitted concentrically to the right and left

of the forward tank housing extension. At the rear, one vibration damper is fitted at the bottom right and one at the top left of the machine.

The vibration dampers are, therefore, the components which have to absorb the vibrations of the saw and are thus subject to high stresses. For this reason it is extremely important that the chain saw be operated only with intact vibration dampers to insure that the full benefit of the AV system is maintained. It is also important to insure that the fasteners and self-tapping screws in the plugs are always properly tightened.

Always replace vibration dampers if they show any signs of damage. A new method of attachment was developed for the two front and rear right-hand vibration dampers (annular buffers). These vibration dampers are only screwed to the tank housing. Attachment to the crankcase is effected by means of an interference fit, i.e. when the self-tapping screws are tightened down, the plugs expand and brace the annular rubber buffers against the wall of the seats in the crankcase.

To replace any one of these three vibration dampers, first unscrew the self-tapping screw from the plug, then re-insert screw about one turn to grip and remove the plug from the vibration damper. Remove mounting screw and then use a suitable screwdriver to push the vibration damper out of its seat from the tank housing side.

Top:
Removing self-tapping screw

Bottom:
Withdrawing plug

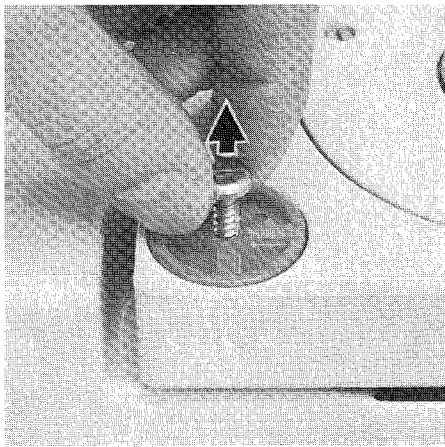
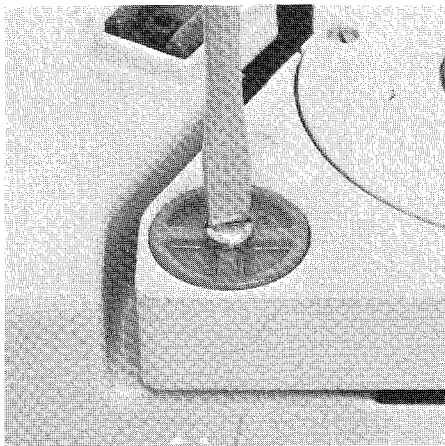

The inner sideplate must be unscrewed before the front right-hand vibration element can be removed.

When installing the new vibration damper, make sure that it is fitted up to the stop, bonded steel washer first, in the crankcase seat. Line up hole in steel washer with the tapped hole in the tank housing. Insert and tighten down mounting screw. Then insert plug – it must be flush with

Top:
Pushing out vibration damper

Bottom:
Plug with chain catching bolt

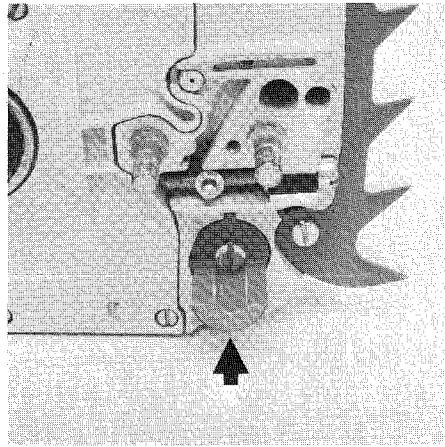
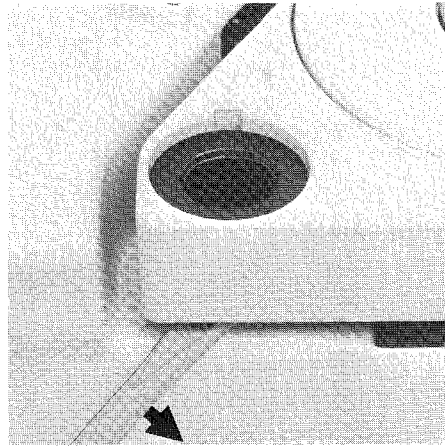

the crankcase face, fit and tighten down the self-tapping screw.

To replace the rear vibration element at the ignition side, first unscrew spark plug and remove the shroud. Remove the collar screw and two M 5 cheese-head screws and take off the vibration damper. Fit new vibration damper, with rubber buffer facing machine, and secure. Then line up holes in vibration

Removing rear vibration damper at ignition side

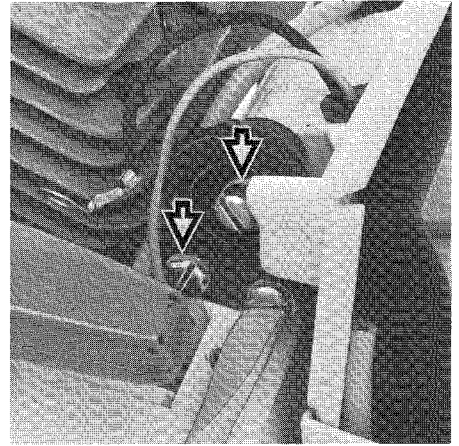

damper and tank housing, insert and tighten down the collar screw.

Refit side plate, shroud and spark plug.

7. MASTER CONTROL

7.1 Construction and Operation

The main part of the master control is the control shaft with an integral multi-function lever, a cam and two further levers. The control shaft is located in the tank housing just forward of the pistol grip and is supported in two bearings.

The master control lever performs the following functions: "Start" (half-throttle; choke valve opened), "Choke" (half-throttle; choke valve closed) and "Stop" (short-circuit contact closed).

The contact sleeve of the short-circuit wire locates in the cam at the left-hand end of the control shaft, the cam also serving as a stop for the contact spring. In the "Stop" position the contact sleeve moves against the contact spring. The lever in the center of the control shaft sets the throttle trigger to half-throttle in the "Start" and "Choke" positions. The actuating lever for the choke valve in the air filter is at the right-hand end of the control shaft.

7.2 Disassembly and Assembly

Top:
Pulling out short-circuit wire

Bottom:
Unscrewing the contact spring

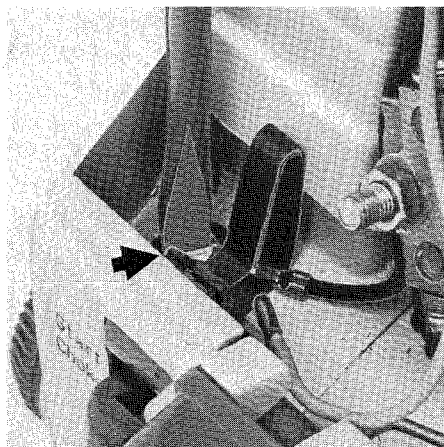
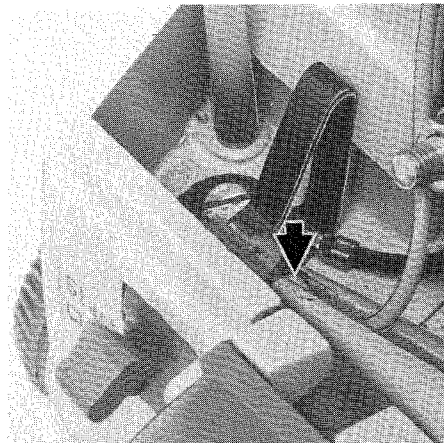

Top:
Detaching throttle linkage

Bottom:
Master control in "Choke" position

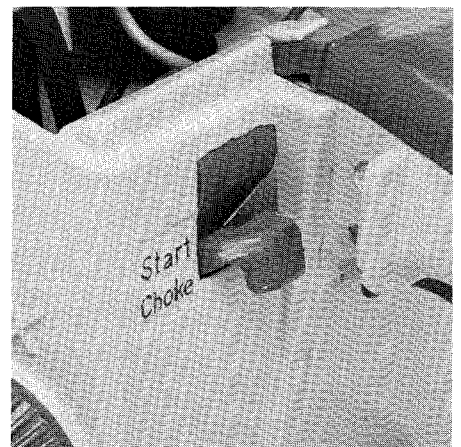
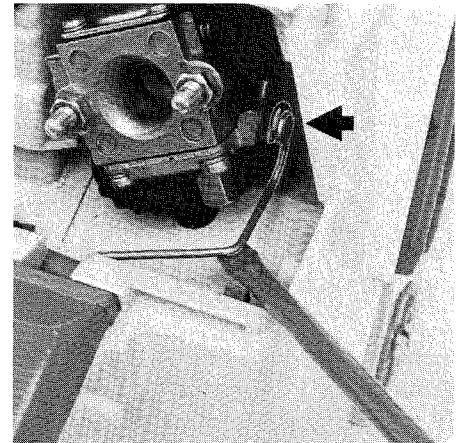

First remove carburetor box cover and air filter and pull short-circuit wire out of the switch cam.

Remove contact spring and ground wire and detach the throttle linkage.

Move master control to "Choke" position. The control shaft can now be taken out of the bearing.

Reverse the above procedure for reassembly.

8. ELECTRIC HANDLE HEATING SYSTEM

8.1 Construction and Operation

The handle heating system heats the handlebar and pistol grip, thus enabling the saw operator to keep a comfortable grip on the saw at extremely low temperatures.

The system comprises an electric heating element in the pistol grip and on the handlebar. The power supply to the system is provided by a generator which has 12 coils wired in series on its star-shaped iron core and is mounted concentrically with the crankshaft in the crankcase behind the flywheel. The permanent magnet of the generator is imbedded in the inner diameter of the flywheel. The heating system's switch is located on the right-hand side of the tank housing.

As on the ignition system, voltage is generated by magnetic induction. Because of the 12 uniformly spaced induction coils on the periphery of the generator, the voltage produced per flywheel revolution is a continuous alternating current. The magnitude of this voltage is dependent on the speed of the flywheel and reaches about 23 volts at 10000 rpm. The system is, therefore, completely safe.

When the switch closes the circuit, an alternating current flows via the connecting wire through the heating element in the pistol grip, the heating element on the handlebar, the switch and back to the generator via ground.

Terminals

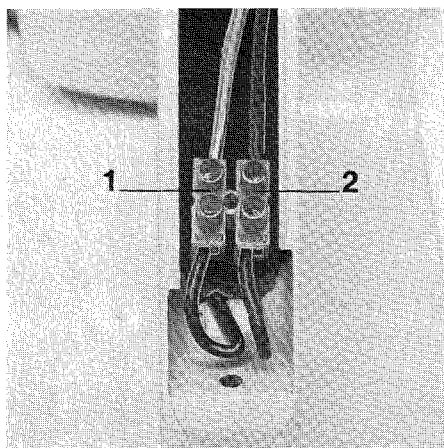

The rating of the generator is such that the pistol grip and handlebar are heated sufficiently, even at extremely low outside temperatures, when the saw is operated within its normal speed range.

The entire handle heating system is maintenance-free and is subject to practically no wear. Faults on the generator, heating elements and wiring are generally caused by mechanical damage.

8.2 Troubleshooting

Failure of the heating system can be caused either by a break in the circuit owing to a faulty lead or component or a short-circuit resulting from damage to the insulation.

To trace the cause of a fault, first remove the carburetor box cover and grip insert and disconnect the generator wire (terminal 1). Now connect one test lead of the ohmmeter 5910 850 4800 to the generator wire and hold the other against terminal 1 (place a pin between the jaws of a crocodile clip to make better contact with the terminal screw). Heater switch to "I". In measuring range " $\Omega \times 1$ ", the ohmmeter should indicate a value between 3.5 and 4 (Ω) if the system is intact. If no reading is obtained, there is a break in the circuit. If the ohmmeter shows a value of less than 3.5 (Ω), there is a short-circuit in one of the components.

In both cases each individual component must be tested separately. The generator wire remains disconnected from the terminal during this process.

The following troubleshooting chart shows the test connections and test values.

Component	Ohmmeter connection (use either test lead)		Resistance Ω		Cause	Remedy
	Lead 1	Lead 2	Nom.	Actual		
Switch	Switch terminal ¹⁾	Ground	0	–	Switch faulty	Replace switch
Heating element in pistol grip	Terminal 1	Terminal 2	1	app. 1	Heating element intact	
				–	Break in wire, heating element damaged	Replace heating element
			0		Short-circuit – damaged insulation	Repair insulation
Heating element on handlebar	Terminal 2	Ground	2	app. 2	Heating element intact	
				–	Break in wire, heating element damaged	Replace handlebar
			0		Short-circuit – damaged insulation	Repair insulation
Generator	Generator wire	Ground	0.6	app. 0.6	Generator intact	
				–	Break in wire, generator damaged	Replace generator
			0		Short-circuit – damaged insulation	Repair insulation

¹⁾ Remove wire

8.3 Disassembly and Repair

8.3.1 Switch

Removing the switch

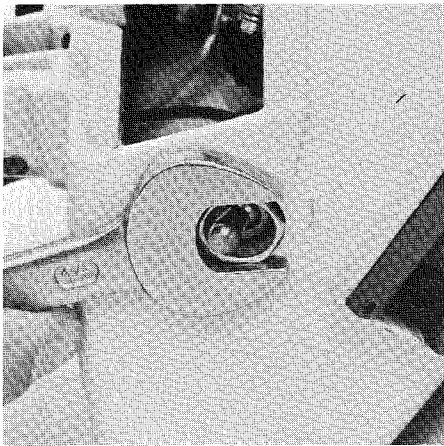

To remove the switch, first take off the carburetor box cover and the air filter. Disassembly is made easier if the grip insert is removed and the throttle linkage detached. Now pull contact sleeve of switch wire out of the switch, unscrew the nut and take the switch out of the housing bore.

When installing the new switch make sure that the slot in the thread of the switch faces towards the pistol grip. Fit and tighten down the nut. Insert contact sleeve in switch terminal and fit rubber boot in position.

Refit throttle linkage, air filter and carburetor box cover.

8.3.2 Heating Element in Pistol Grip

Heating element bonded in position

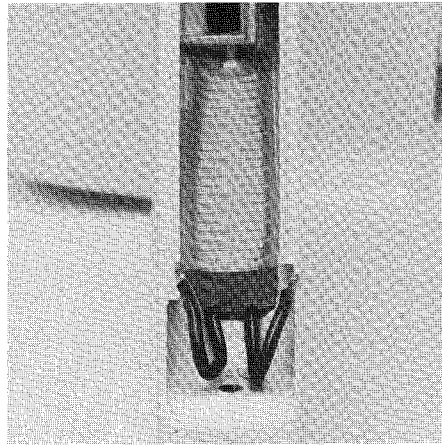

Remove the carburetor box cover and grip insert and then disconnect the heating element's wires from the terminal. The thrust block and heating element can now be taken out of the grip.

The new heating element is self-adhesive. Remove the backing paper and position the heating element in the pistol grip so that the recess engages on the longitudinal rib. Then press down heating element firmly, refit the thrust block and connect up the wires.

Refit grip insert and carburetor box cover.

8.3.3 Handlebar Grip

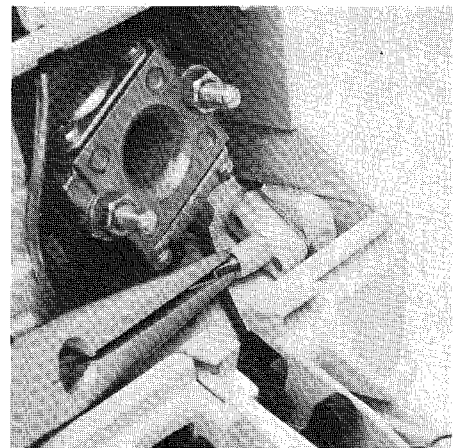
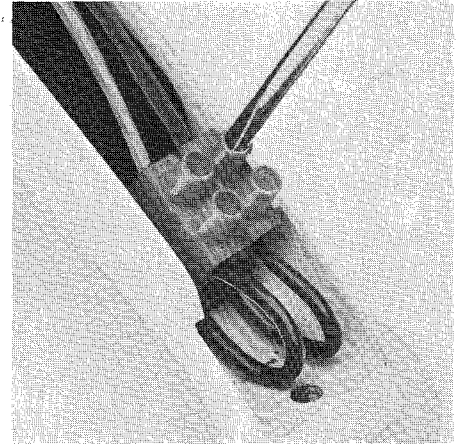
Top:
Disconnecting heating element wireBottom:
Pulling out wire at switch

The heating element on the handlebar is not replaceable. This means that the handlebar must be replaced if the heating element is faulty. The removed handlebar can be used for other 028 chain saws which do not have a handle heating system.

Before disassembling the handlebar, remove the carburetor box cover, air filter, spark plug, shroud and grip insert. Then disconnect the

8.3.4 Generator

Insulating sheath in position

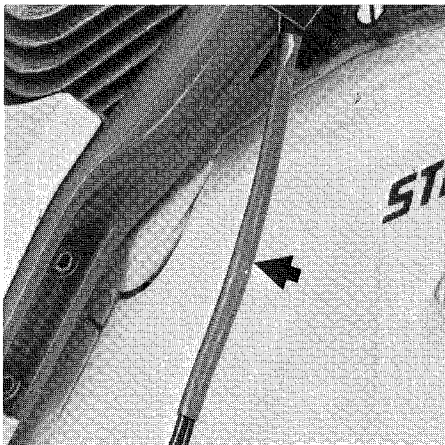

heating element's wire at the terminal block.

Remove rubber boot and disconnect the other wire from the switch and then pull both wires out of the grommet in the tank housing. Unscrew the four M 5 x 16 socket head screws and take handlebar off the tank housing.

The reserve sequence is used for assembly of the new handlebar. After fitting the insulating sheath, insert heating element wires through the grommet in the tank housing. Insert short wire (after fitting rubber boot) in switch and connect the long wire to the terminal block. The short wire should be routed behind the fuel line.

Refit grip insert, shroud, spark plug, air filter and carburetor box cover.

Top:
Disconnecting generator wire

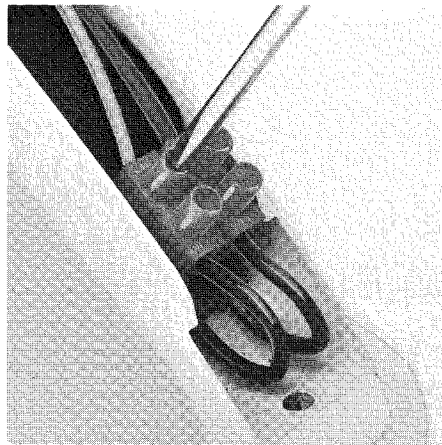

Bottom:
Removing the generator

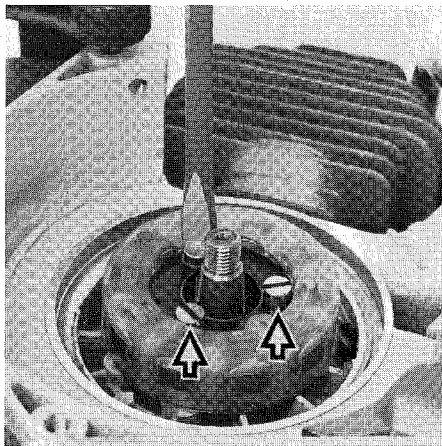

First remove the flywheel (4.4.5), air filter, shroud and grip insert. Disconnect generator wire from terminal block (terminal 1) and pull it back as far as the weatherproof grommet in the crankcase. Remove the three generator mounting screws. Now lift off the generator and pull out wire completely. When reassembling, first insert generator wire through the weatherproof grommet in the crankcase. Then position generator on the flange so

Aligning generator with special centering sleeve 1118 893 2405

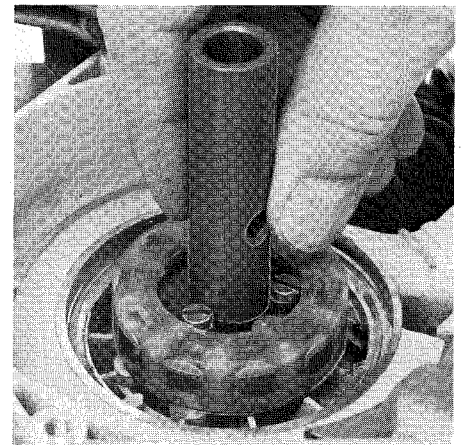

that the wire fits in the recess. Coat mounting screws with adhesive 0786 111 1109 (LOCTITE 270 or 73) before fitting. The generator must be centered before tightening down the mounting screws to insure that it does not foul the flywheel. To do this, fit centering sleeve on the crankshaft so that the slot engages on the key.

Refit and connect up wire in original position. Finally remove centering sleeve and reassemble remaining parts.

9. CHAIN OIL

9.1 Construction and Operation of Oil Pump

Diagram of oil pump:

- 1 – Spurgear
- 2 – Worm
- 3 – Helical edge
- 4 – Cylindrical roller
- 5 – Pump housing
- 6 – Pump plunger

Intake stroke

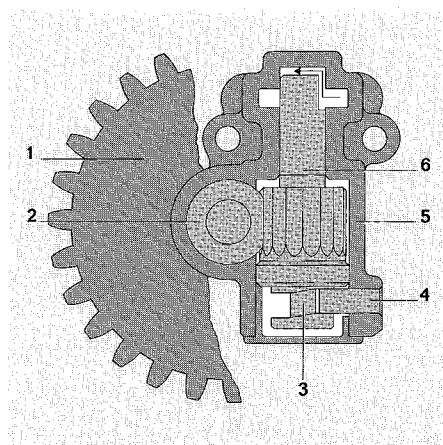

Delivery stroke

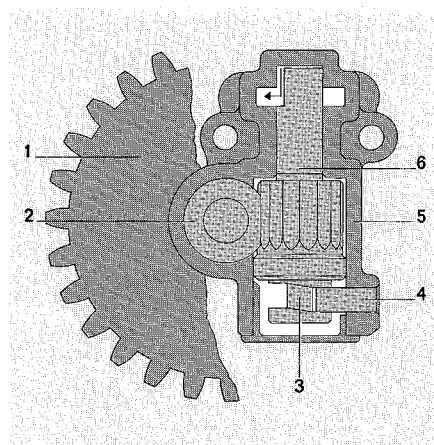

The oil pump feeds the chain lubricating oil from the oil tank to the guide bar and chain and is located on the clutch side of the crankcase.

The oil pump is driven by the clutch drum via two spur gears. The driving gear is a ring gear with a sliding fit on the hub of the clutch drum. The lugs on the inner diameter of the ring gear engage positively with the clutch drum when the chain sprocket is fitted. The driven spur gear is mounted on the shaft of the single thread worm in the pump housing and drives the pump plunger at an overall reduction ratio of 1:23. This means that the pump plunger rotates once for every 23 revolutions of the chain sprocket.

The suction and delivery action of the pump plunger is effected in that it performs a vertical stroke during each revolution. This vertical stroke is brought about by a cylindrical roller in the pump housing which engages on a helical edge on the end of the pump plunger. When the plunger rotates it performs a continuous vertical stroke with a travel equal to the pitch of the helical edge.

The pump plunger moves downwards on its intake stroke and creates a depression at the inlet port. This causes oil to be drawn out of the oil tank and into the pump housing. An oil pocket at the top of the plunger collects the oil at the intake port and transfers it to the outlet port

on its upward stroke, thus compressing the oil and forcing it through the outlet port and pipe to the cutting attachment.

The oil delivery rate is in a fixed linear ratio to the chain speed. This means there is always a sufficient supply of lubricating oil to the guide bar and chain at all engine speeds. The pump delivery rate is $8 \text{ cm}^3/\text{min}$. at 6000 rpm.

The chain lubricating oil is filtered by the pickup body in the oil tank to prevent any impurities reaching the oil pump.

In order to project the cutting attachment from unnecessary wear, make sure that the oil pump is always in good working order.

9.2 Troubleshooting Chart

In the event of faults in the chain lubricating system, always investigate the other possible sources of faults before disassembling the oil pump.

Fault	Cause	Remedy
No lubricating oil at chain	Oil tank empty	Fill up with oil
	Oil inlet bore in guide bar is blocked	Clean oil inlet bore
	Intake line or oil pickup body (strainer) clogged or intake line ruptured	Wash intake line and pickup body (strainer) in clean gasoline and blow out with compressed air; renew if necessary
	Valve in oil tank blocked	Clean or renew valve
	Teeth on spurgears or pump worm worn	Install new spurgears
Machine losing chain oil	Cylinder bore in pump housing worn	Fit new pump housing
	O-ring on pump plunger worn	Renew O-ring
Oil pump delivers too little oil	Cylinder bore in pump housing worn	Fit new pump housing

9.3 Oil Tank/Tank Vent

The chain oil tank is an integral part of the crankcase. The fitting in the tank, to which the intake line and pickup body are connected, terminates in the crankcase at the oil pump's intake port. During the pump intake stroke, the chain oil is drawn through the pickup body, intake line and fitting from the oil tank.

A precondition for correct operation of the oil pump is that the pressure in the pump chamber during the intake stroke is less than that in the oil tank. However, the oil tank is sealed air-tight by the filler cap and this would cause a vacuum to be created in the tank when the oil level drops, thus negating the suction of the oil pump, if a valve were not installed to equalise the difference in pressure between atmosphere and the tank. This valve is installed in the tank wall and opens at a depression of approx. 0.1 bar (kp/cm²) to insure that the depression in the oil tank never exceeds this value. The valve has a nonreturn action and effectively prevents chain oil leaking from the tank irrespective of the position of the chain saw.

9.4 Repairing Pickup Body and Valve

Unscrewing the side plate

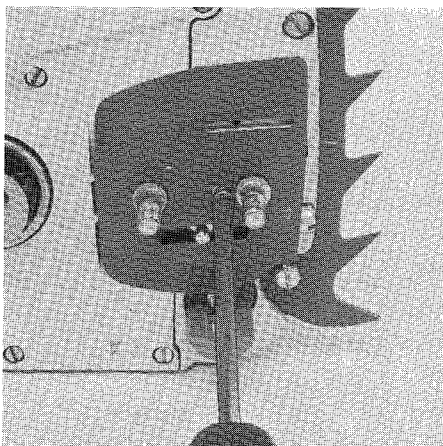

Top: Removing the chain sprocket

Bottom: removing the valve

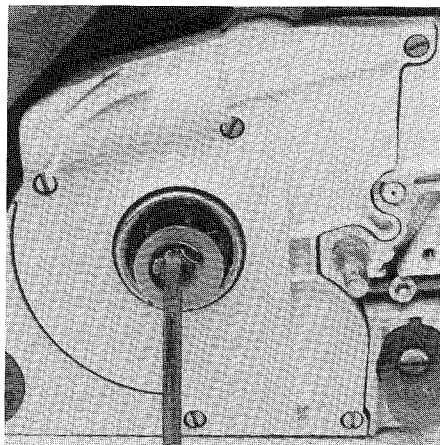

To remove or replace the intake hose and pickup body, first empty the oil tank. Then use a suitable pair of pliers to pull the intake hose off the fitting. Bend back the hose bell and remove the pickup body.

Wash the intake hose and pickup body in clean gasoline and blow out with compressed air. Refit clean or new parts in reverse sequence.

If the valve is blocked with dirt, blow it out with compressed air from outside the tank and then flush out the tank. The side plate, chain sprocket and cover must be removed in order to replace a defective valve. Lever the valve out of its bore with two screwdrivers or similar tools. Press or drive in new valve carefully until the rear edge of the annular groove is flush with the front edge of the bore.

Refit cover, chain sprocket and side plate.

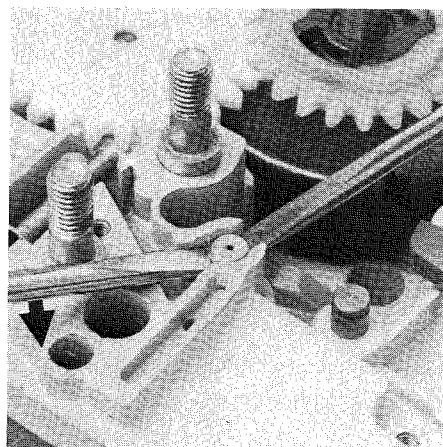

9.5 Disassembly and Repair of Oil Pump

Top:
Removing the cover

Bottom:
Unscrewing the spurgear

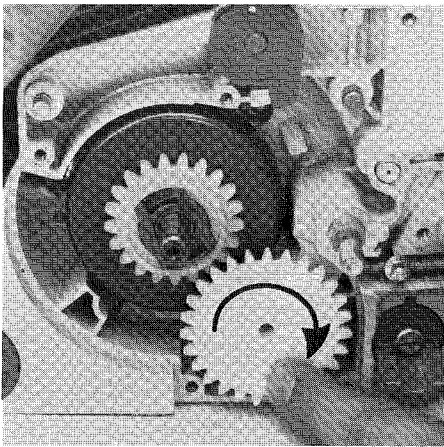
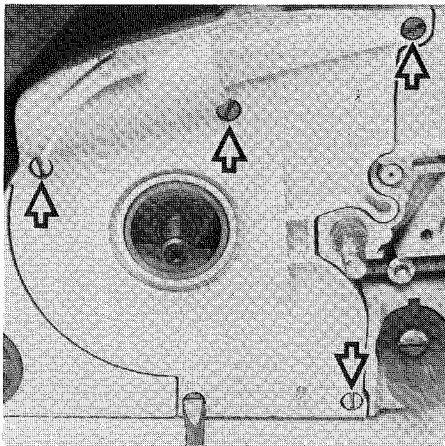

If trouble persists after all other possible sources of faults have been investigated and rectified, the cause must be in the oil pump.

To remove the oil pump, first empty the oil tank and disassemble the bar and chain, chain sprocket, side plate and cover. Unscrew the spur gear and the two M 4x12 cheese-head screws holding the oil pump

Top:
Unscrewing the oil pump

Bottom:
Withdrawing the cylindrical roller

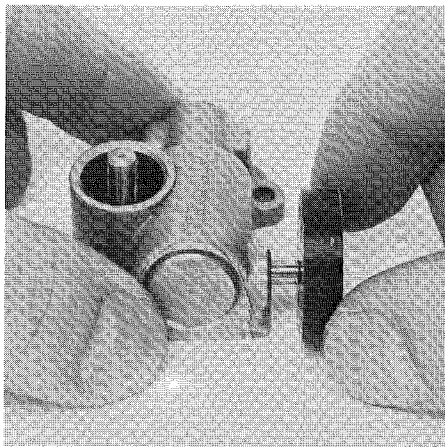
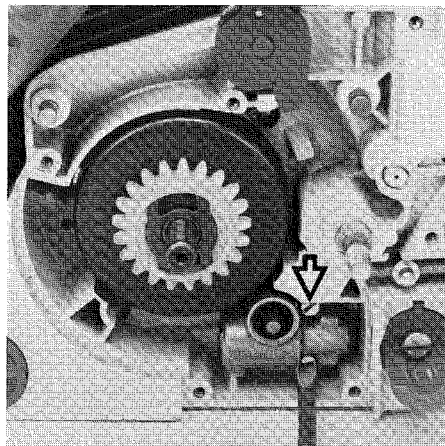

and then take oil pump with gasket out of the crankcase.

To disassemble the oil pump, first pull cylindrical roller out of the pump housing with a magnet. If cylindrical roller does not come out easily, turn plunger backwards and forwards to free it off. The pump plunger can now be knocked out of the housing — if it does not drop out of its own accord. To do this, hold the pump housing in the palm of your hand,

Component parts of oil pump

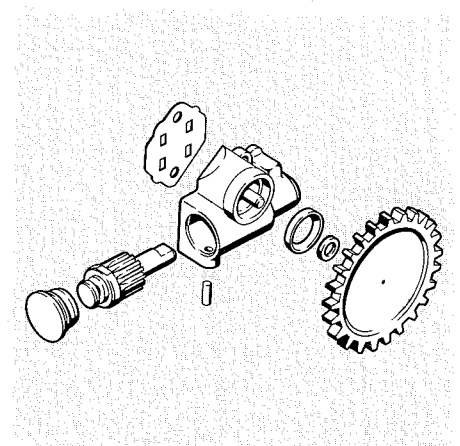

with cylinder bore facing downward, and knock the side of your hand against a firm base until the plunger emerges.

Clean pump housing and pump plunger in clean gasoline and blow out with compressed air, paying special attention to the ports. Replace any damaged parts. Always fit a new O-ring and coat the helical edge and teeth of the plunger with grease before assembly. Install the plunger and refit the cylindrical roller.

Make sure the gasket is correctly positioned when installing the oil pump. Refit other parts in reverse sequence to that of disassembly.

10. FUEL SYSTEM

10.1 Construction and Operation of Carburetor

The all-position diaphragm carburetor comprises the fuel pump and the carburetor body itself. The fuel pump operates as a completely separate and independent unit although it shares a common housing with the carburetor.

10.1.1 Operation of Fuel Pump

The pressure in the crankcase varies with each stroke of the piston. The piston creates a depression in the crankcase on its upward stroke and overpressure on its downward stroke. This process is utilized for actuation of the fuel pump. The chamber in front of the pump diaphragm (pulse chamber) is connected to the crankcase by a pulse line. The changes in pressure act directly on the pump diaphragm and cause it to move in time with the piston. Control is effected by means of two flap valves stamped into the pump diaphragm.

The depression created by the upward stroke of the piston draws the pump diaphragm into the pulse chamber. This enlarges the pump chamber and creates a vacuum. The inlet valve then opens and the higher atmospheric pressure forces fuel from the tank into the pump chamber and presses the outlet valve onto its seat.

The downward stroke of the piston changes the relative pressures.

An overpressure is built up in the crankcase and pump chamber which presses the diaphragm against the pump chamber and exerts pressure on the fuel. The overpressure forces the inlet valve to close while the other valve opens and allows fuel to flow to the carburetor's needle valve.

10.1.2 Operation of Carburetor

The opening and closing action of the needle valve and, therefore, the supply of fuel to the carburetor is controlled by the metering diaphragm. The metering diaphragm is in a position of rest when atmospheric and diaphragm chamber pressure are equal (the chamber in front of the diaphragm is connected to atmosphere).

The cone of the inlet needle is held on its seat by spring pressure.

The metering diaphragm chamber is filled with fuel when the engine is running. A depression is created in the choke tube (venturi) during the induction stroke. Fuel is drawn into the choke tube through the jet bores between the choke tube and diaphragm chamber. This in turn produces a depression in the diaphragm chamber and the atmospheric pressure of the free air presses the metering diaphragm towards the carburetor body. The force generated by the pressure

difference times diaphragm area acts on the inlet control lever via the perforated disc on the diaphragm, overcomes spring force and lifts the inlet needle off its seat. This allows fresh fuel to flow from the pump chamber into the diaphragm chamber. The needle valve closes again as soon as atmospheric pressure is reached in the metering diaphragm chamber. Under normal operating conditions the needle valve does not open and close constantly. The metering diaphragm actually settles down to a mean level, depending on engine speed and the needle valve remains open relative to the diaphragm's position.

The quantity of fuel drawn into the choke tube depends on the amount of depression, and this in turn is influenced by the position of the choke and throttle valves. The volume of fuel can be altered to suit different operating conditions by means of adjustment screws for the idle and main jets.

Top:
Starting position

Bottom:
Idle position

- 1 – Pulse nipple
- 2 – Inlet valve open
- 3 – Fuel intake
- 4 – Choke valve
- 5 – Valve jet
- 6 – High-speed adjustment screw
- 7 – Pump diaphragm (intake position)
- 8 – Outlet valve closed

Top:
Changing from idle to part or full-throttle position

Bottom:
Full-throttle position

- 9 – Throttle valve
- 10 – Secondary idle jet
- 11 – Primary idle jet
- 12 – Low-speed adjustment screw
- 13 – Metering diaphragm chamber
- 14 – Metering diaphragm
- 15 – Connection to atmosphere
- 16 – Inlet control lever
- 17 – Inlet needle

(both adjustment screws are drawn offset by 90°)

Four basic operating conditions are described below to explain the function of the carburetor:

1. The choke valve is closed and the throttle valve partly opened during the **starting process**. A powerful vacuum is created in the choke tube during the induction stroke because the entry of outside air is almost completely restricted by the closed choke valve. This means that the engine draws in a large amount of fuel through all the jets and relatively little air. A rich starting mixture is obtained in this way. The choke valve must be opened as soon as the engine fires – the mixture would otherwise be too rich and stall the engine.

2. In the **idling operation** only little fuel is needed. The choke is fully opened while the throttle shutter is nearly closed. The vacuum acts on the **primary idle discharge port** only. Because of the difference in pressure between the venturi and the intake behind the throttle shutter, "wrong" air would enter the diaphragm chamber through the main orifice, the air-fuel mixture would become too lean and the engine would stop. This condition is prevented by a small plate which closes the main orifice when there is no vacuum in the venturi.

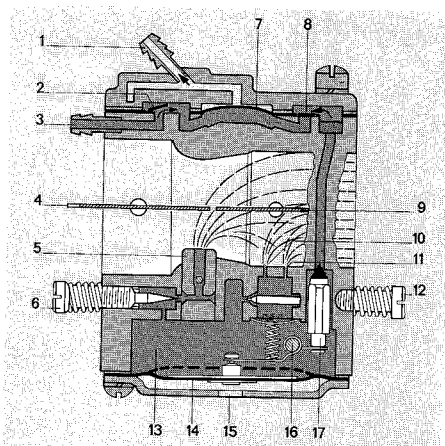
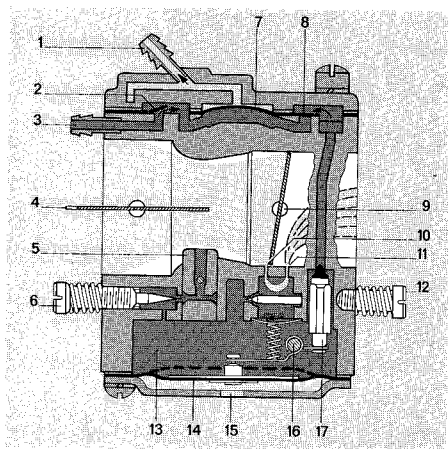
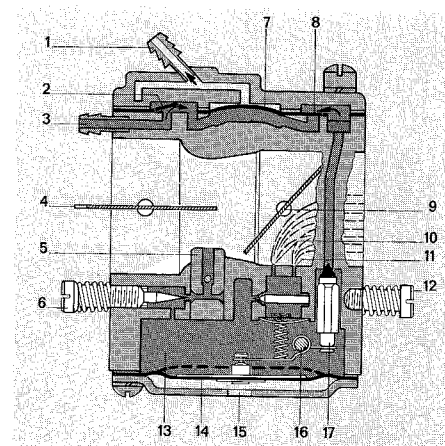
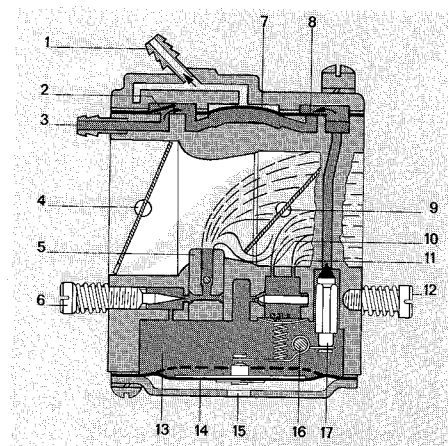

3. During the **changeover** from idle to part or full-throttle sufficient fuel must be drawn in with the suddenly increased flow of air when the throttle valve is opened. This is effected by means of the **secondary idle jet** which is exposed to the effects of vacuum at this point, thus producing the richer, ignitable mixture required.

4. Opening the throttle valve further brings the **main jet (valve jet)**, lo-

cated at the narrowest point of the choke tube, into operation and provides the fuel required for **full-throttle operation**.

10.2 Troubleshooting Chart

Fault	Cause	Remedy
Carburetor floods; engine stalls	Inlet valve not sealing. Foreign matter in valve seat or seat damaged	Remove and clean or renew inlet needle
	Helical spring not properly located on dimple of inlet control lever	Remove inlet control lever and refit correctly
	Perforated disc on diaphragm is deformed and presses constantly against inlet control lever	Fit new metering diaphragm
	Inlet control lever too high (relative to design position)	Set inlet control lever flush with top edge of plate
Engine does not respond properly to throttle	Idle jet "too lean"	Back off low-speed adjustment screw slightly (see Carburetor Adjustment)
	Inlet control lever too low (relative to design position)	Set inlet control lever flush with top edge of plate
	Vent bore to atmosphere blocked	Clean bore
	Diaphragm gasket leaking	Fit new diaphragm gasket
	Metering diaphragm damaged	Fit new metering diaphragm
Engine will not idle	Throttle valve opened too far by idle speed adjustment screw	Readjust idle speed adjustment screw

Fault	Cause	Remedy
Engine stalls at idle speed	Idle jet bores or ports clogged	Clean jet bores and blow out with compressed air
	Idle jet "too rich"	Tighten low-speed adjustment screw slightly (see Carburetor Adjustment)
	Idle speed adjustment screw incorrectly set – throttle valve completely closed	Set idle speed adjustment screw correctly
Engine speed drops off quickly under load – low power	Air filter plugged	Clean air filter
	Tank breather faulty	Clean tank breather or replace if necessary
	Leak in fuel line from tank to fuel pump	Seal or renew connections and fuel line
	Pump diaphragm damaged	Fit new pump diaphragm
	Main jet bores or ports clogged	Clean bores and ports
	Fuel strainer plugged	Clean fuel strainer

See also 3.2

10.3 Leakage Test (Pressure Test) on Carburetor

Tester connected up

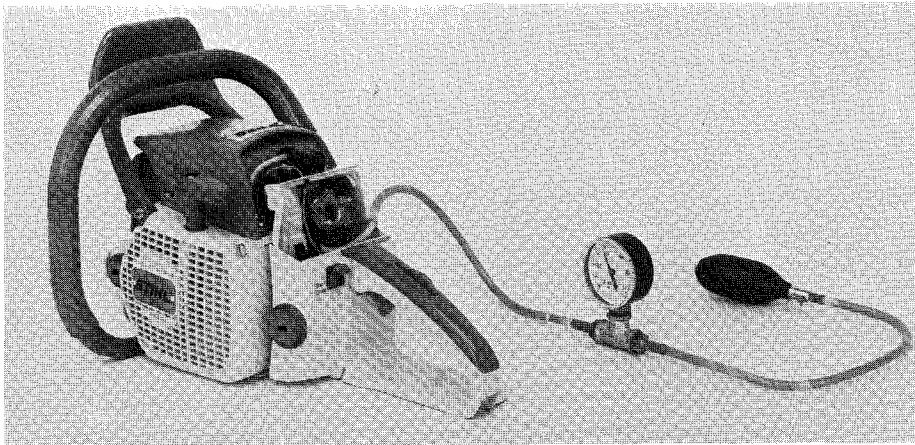

The carburetor can be tested for leaks with the carburetor and crankcase tester 11068502900.

To do this, remove carburetor box cover and air filter and pull fuel line off the elbow fitting. As the inside diameter of the test tube is larger than the outside diameter of the elbow fitting, a fuel line (11101418600) must be used as an adapter to make the connection. One end of the fuel line is then pushed onto the elbow fitting and the other end into the tester's tube.

Now close vent screw on rubber bulb and pump air into the carburetor until the pressure gauge indicates a pressure of 0.4 to 0.5 bar (kp/cm²).

If this pressure remains constant, the carburetor is airtight. However, if it drops, there are two possible causes:

Bottom:
Closing the vent screw

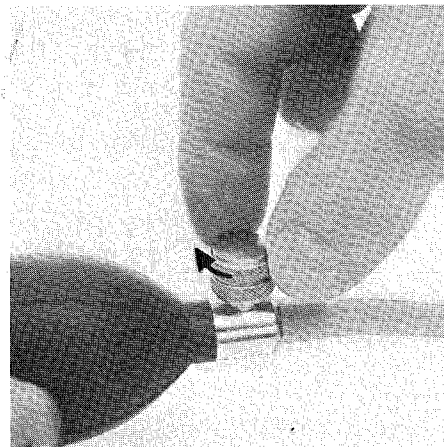

1. The inlet needle is not sealing (foreign matter in valve seat or cone of inlet needle damaged).

2. The metering diaphragm is damaged.

In either of these cases the carburetor must be removed and repaired.

10.4 Disassembly of Carburetor

Removing carburetor

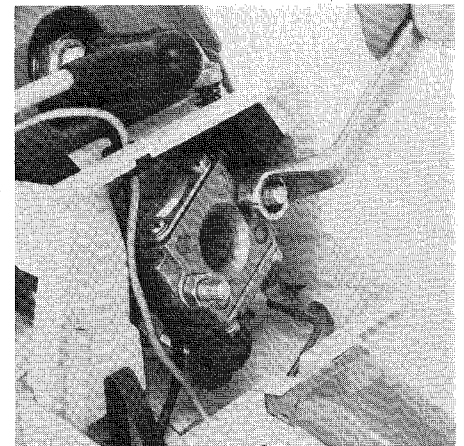

Remove the carburetor box cover and air filter. Then detach the throttle linkage from the lever on the throttle shaft and pull fuel line off the elbow fitting.

Slacken off and remove the two M 5 hexagon nuts which hold the carburetor on the studs. The carburetor can now be lifted off the studs and the pulse line disconnected from the elbow fitting with a screwdriver at the same time.

10.5 Carburetor Repair

Removing end cover at pump side

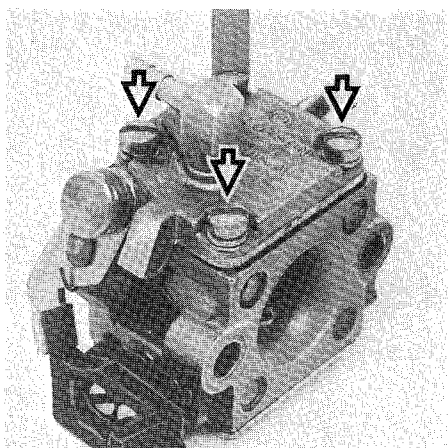

It is advisable to check the serviceability of the fuel pump whenever the carburetor has been removed for repair.

Unscrew the end cover at the pump side and remove the gasket and pump diaphragm. The end cover, gasket and diaphragm are frequently stuck firmly together. If this is the case, take particular care when separating them. If the fuel strainer in the pump side of the carburetor body is dirty, it should be lifted out with a screwdriver and washed in clean gasoline. Always replace fuel strainer if it shows any signs of damage.

To disassemble the carburetor body, unscrew the metering diaphragm cover and remove the metering diaphragm and gasket. This diaphragm and the gasket may also be stuck together and must be separated carefully.

Removing metering chamber cover

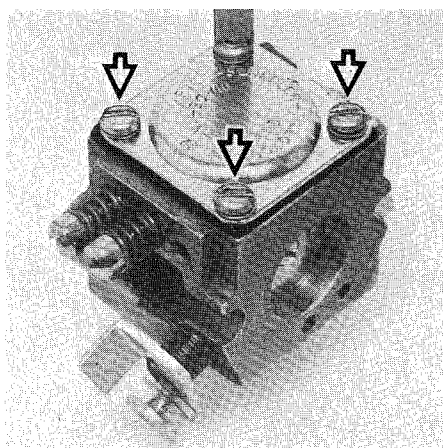

The diaphragms are the most delicate parts of the carburetor. Due to the continuous alternating stress to which the diaphragms are subjected, the material eventually shows signs of fatigue – the diaphragms distort and swell. When this stage is reached the carburetor can no longer function correctly and the diaphragms must be replaced.

The inlet valve is located in a recess in the metering diaphragm chamber. The inlet control lever with spindle, helical spring and inlet needle can be removed after unscrewing the M 3 x 6 oval-head screw. If an annular indentation is visible on the cone of the inlet needle, it should be replaced as it will no longer seal properly. This is indicated by constant flooding of the carburetor although the needle is clean.

If the small plastic plate in the valve

Top:
Removing inlet needle valve

Bottom:
Pressing out valve jet

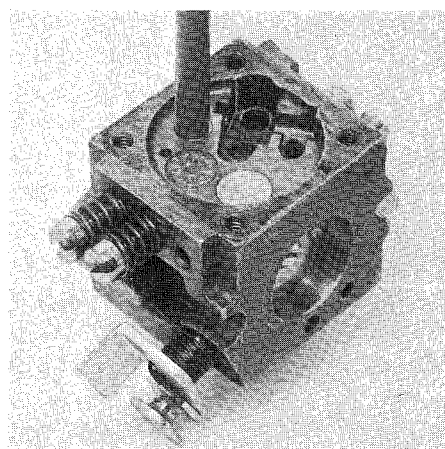
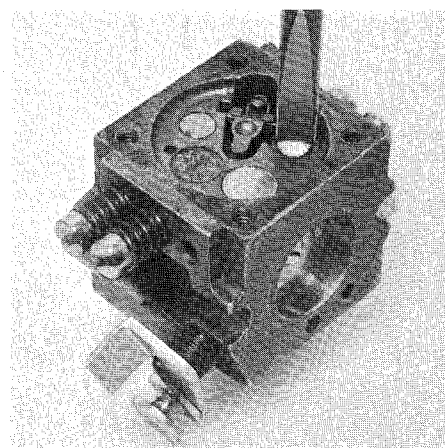

jet (main jet) no longer moves freely or is stuck, press or knock out the jet from the diaphragm chamber side towards the choke tube using a suitable tool of about 5 mm (0.2") dia.

Top:
Pressing out blanking plug

Center:
Hole in metering diaphragm cover

Bottom:
Locating lugs on end cover

Wash all parts of the carburetor in clean gasoline (never use high octane gasoline) and blow out, bores and ports in particular, with compressed air. Unscrew both adjustment screws for this purpose.

Check blanking plug 11131229400 for leaks by coating it with oil and applying a compressed air line to the bore for the low speed adjustment screw. If air bubbles appear in the oil, carefully peen over the circumference of the blanking plug and check again. Fit a new plug if leaks persist.

To remove old plug, apply a punch of about 3 mm (0.12") dia. to the center of the plug. Press or tap punch until plug buckles downwards and is released from the wall of the bore. Take out plug and blow through idle bores with compressed air.

Fit new blanking plug in bore with curvature facing upwards and then press it flat with a punch of about 8 mm (0.32") dia.

When inserting the valve jet make sure that it is exactly vertical and not canted. The rear edge of the valve jet must be flush with the bottom of the diaphragm chamber.

Fit inlet needle and helical spring in their respective bores. Insert spindle in inlet control lever, engage clevis in annular groove on head of

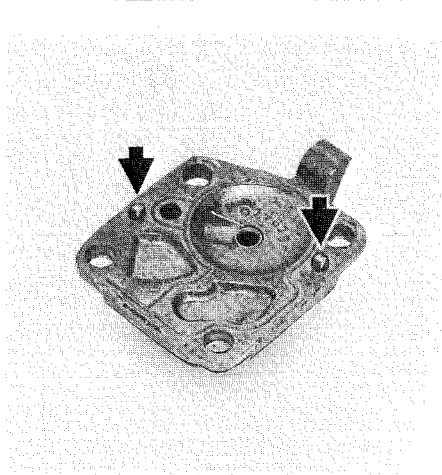
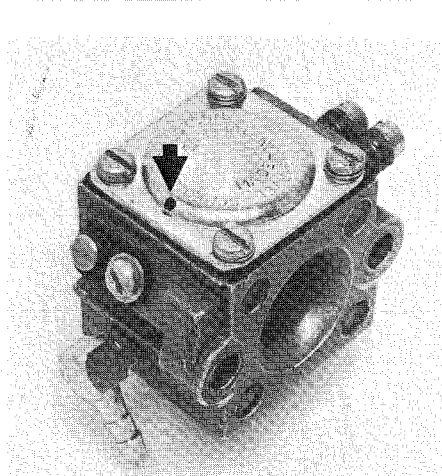
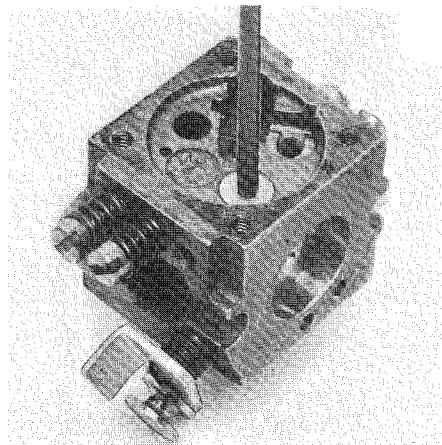

inlet needle and secure with oval-head screw. Make sure that the helical spring locates on the control lever's dimple. Tighten down oval-head screw and check freedom of movement of inlet control lever.

Refit gasket, metering diaphragm and cover on the carburetor body and screw down firmly. The hole in the cover must face away from the adjustment screws.

Now fit and secure the fuel strainer, pump diaphragm, gasket and end cover. The two integrally cast lugs on the end cover locate the pump diaphragm and gasket.

Installation of the carburetor is then a reversal of the disassembly procedure. The elbow fitting locates automatically in the pulse line when the carburetor is pushed into position.

10.6 Carburetor Adjustment

- 1 High-speed adjustment screw
- 2 Low-speed adjustment screw
- 3 Idle speed adjustment screw

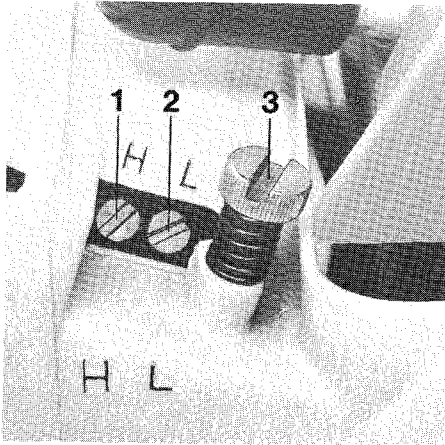

Always carry out carburetor adjustment with the engine warm and the air filter clean.

10.6.1 Notes for Fine Adjustment of Carburetor

Engine stops while idling:

Turn idle speed adjustment screw slightly clockwise while engine is running (chain should not rotate).

Chain turns at idle speed:

Turn idle speed adjustment screw slightly counter-clockwise.

Engine runs erratically at idle speed:

Adjust at low-speed adjustment screw. Turn clockwise for leaner mixture or counter-clockwise for richer mixture.

Important:

Even very slight alteration of the adjustment screw settings has a substantial effect on engine performance.

The carburetor was adjusted at the factory to provide high power and low fuel consumption under local atmospheric conditions. If the chain saw is operated at high altitudes (mountains) or near sea level, the basic adjustment of the carburetor must be changed. This correction is made at the two adjustment screws and the idle speed adjustment screw.

Both adjustment screws must be carefully screwed down onto their seats before making the basic adjustment – only intended as a guide for fine adjustment. Then adjust as follows:

High-speed screw H:

Open $1\frac{1}{4}$ turns

Low-speed adjustment screw L:

Open $1\frac{1}{4}$ turns

Do not interchange the adjustment screws.

10.7 Fuel Line and Tank Breaker

Withdrawing picking body with hook
11108938800

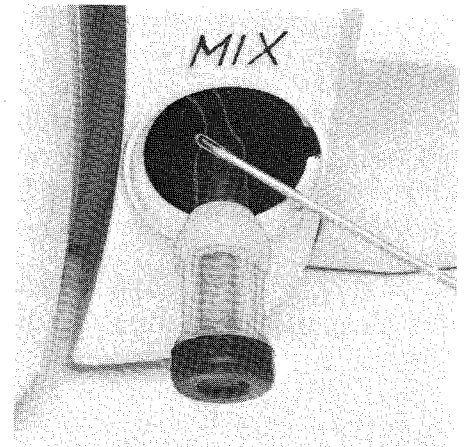

The diaphragm pump draws fuel out of the tank and into the carburetor via fuel line. Any impurities mixed with the fuel in the tank are filtered out by the pickup body (filter and strainer). The wire mesh in the pickup body and fine pores of the filter eventually become plugged with minute particles of dirt. This restricts passage of fuel and the result is fuel starvation.

In the event of trouble with the fuel supply system, always clean the pickup body first. To do this, pull the pickup body out through the tank filter and disconnect it from the hose. Remove the cap and then take out the filter, strainer and insert. Carefully clean all parts. Do not damage the wire mesh in the pickup body.

10.8 Air Filter and Choke Valve

It is not advisable to clean the filter – always fit a new one. Take this opportunity to clean the fuel tank by flushing it out with clean gasoline and then reverse the above to assemble all the parts.

To replace a faulty pickup hose, remove the air filter. Use a screwdriver to prise the bead of the hose out of bore in the tank housing, disconnect the pickup body and then pull out the hose. The new hose is fitted in the reverse sequence. Make sure the bead of the pickup hose is not damaged while being pressed into position.

Correct operation of the carburetor is possible only if atmospheric and fuel tank pressure are equal. This is assured by the tank breather. The breather passage is formed by the free space between the threads of the grub screw which is inserted in the breather hose.

If faults occur on the carburetor or the fuel supply system, always check and clean the tank breather. If the flanks of the thread have cut deeply into the hose, fit a new hose.

Prising apart the two halves of the filter

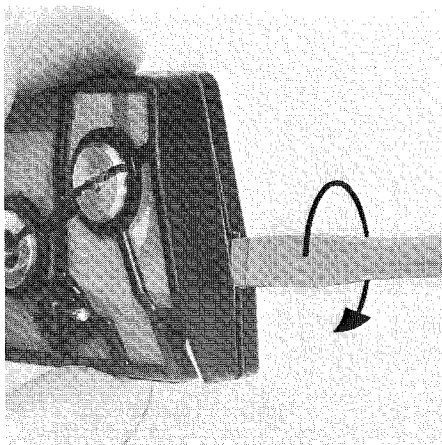

The air filter's function is to intercept dust and dirt in the combustion air and thus reduce wear on engine components.

Clogged air filters have a detrimental effect on engine performance, increase fuel consumption and make starting more difficult.

To remove the filter, take off carburetor box cover by turning twist lock counter-clockwise. Clean dirt off filter and area surrounding it before removing. Now unscrew the two slotted nuts in the air filter and lift the complete filter off the studs. Use a screwdriver to prise apart the two halves of the filter; a recess is provided in the rear half of the filter for this purpose. The choke valve is mounted in the front half of the filter and is normally held in the "open" position by the tension spring. Detach tension spring to release choke valve from filter.

Master control in "Choke" position



Wash both parts of the filter in clean gasoline and blow out with compressed air.

If the wire mesh is damaged in any way, renew the part of the filter concerned; the engine can be permanently damaged by dirt drawn in with the combustion air.

Move the master control away from the "Choke" position and then reverse the above sequence to install the filter.