



ECHO®



shindaiwa®

Engine FAILURE Analysis Booklet



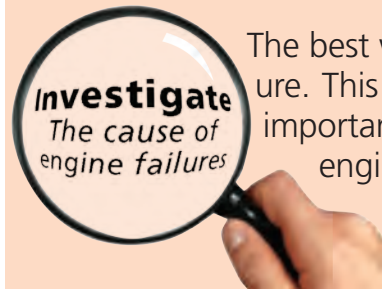

The best way to analyze an engine failure is by investigating what caused the failure. This is very similar to a detective looking for evidence at a crime scene. It's important not just to look at engine damage. Instead, look for clues outside the engine, test some components and then pull the cylinder to look for more clues inside the engine. The most accurate cause of an engine failure can be determined once all the available facts are assembled.

Table of Contents

<i>INTRODUCTION.....</i>	<i>2</i>
<i>2-STROKE ENGINE FUNDAMENTALS.....</i>	<i>3</i>
<i>ENGINE FAILURE BASICS.....</i>	<i>4</i>
<i>SPECIAL TOOLS.....</i>	<i>8</i>
<i>SERVICE INFORMATION.....</i>	<i>9</i>
<i>OUTSIDE ENGINE CHECKS & TESTS.....</i>	<i>10</i>
<i>INSIDE ENGINE CHECKS.....</i>	<i>16</i>
<i>RAW GAS FAILURES.....</i>	<i>19</i>
<i>DIRT INGESTION FAILURES.....</i>	<i>20</i>
<i>LEAN SEIZE FAILURES.....</i>	<i>22</i>
<i>OVERHEATING FAILURES.....</i>	<i>24</i>
<i>DETONATION / PRE-IGNITION.....</i>	<i>27</i>
<i>STALE FUEL FAILURES.....</i>	<i>28</i>
<i>UNCERTIFIED 2-STROKE OIL FAILURES.....</i>	<i>30</i>
<i>MECHANICAL DAMAGE FAILURES.....</i>	<i>32</i>
<i>ENGINE FAILURE REVIEW.....</i>	<i>33</i>
<i>MIX LUBRICATED 4-STROKE FUNDAMENTALS.....</i>	<i>34</i>
<i>MIX LUBRICATED 4-STROKE OUTSIDE CHECKS.....</i>	<i>36</i>
<i>MIX LUBRICATED 4-STROKE OUTSIDE CHECKS.....</i>	<i>38</i>
<i>MIX LUBRICATED 4-STROKE INSIDE CHECKS.....</i>	<i>39</i>
<i>MIX LUBRICATED 4-STROKE DIRT INGESTION.....</i>	<i>40</i>
<i>MIX LUBRICATED 4-STROKE RAW GAS.....</i>	<i>41</i>
<i>MIX LUBRICATED 4-STROKE STALE FUEL.....</i>	<i>42</i>
<i>VALVE TRAIN FAILURES.....</i>	<i>43</i>



Advantages – Two-Stroke engines have only three major moving parts; the piston, the connecting rod, and the crankshaft assembly. The crankcase is compact because there is no need for a reservoir of motor oil. The simple design and compact size reduces weight. The 2-Stroke design inherently produces high-revving engines with a very high power-to-weight ratio. These advantages make 2-Stroke engines a common choice for use in high power, handheld equipment where light weight and speed is essential; primarily string trimmers, chain saws, power blowers, etc.

Basic 2-Stroke Engine Operation – The 2-Stroke engine crankshaft makes one revolution for each upstroke and down stroke. Each single revolution of the crankshaft an air/fuel/oil mixture charge is drawn into the engine, the mixture is compressed & ignited creating power, and lastly exhaust gases exit the engine.

Two-Stroke engines produce a power stroke every revolution of the crankshaft

Improvements – Most modern 2-stroke engines are over 8 times cleaner than pre-1995 (CARB 1) pre-regulation models. Newer 2-Stroke engines must run more efficiently to meet stringent emissions standards but the improvements also result in higher engine temperatures. Higher engine temperatures increases the importance of correct fuel mix oil, spark plug heat range, carburetor adjustments and changes how we look at the cause of engine failures.

Piston Port 2-Stroke Engine Operation

UPSTROKE

Intake (Below the piston) – The carburetor of a piston port 2-Stroke engine is mounted on the side of the cylinder over the intake port. The crankcase is sealed from outside air. As the piston moves from Bottom Dead Center (BDC) to Top Dead Center (TDC) a vacuum is created down in the crankcase. When the piston skirt moves up far enough to uncover the intake port, vacuum in the crankcase will draw in air/fuel/oil mixture from the carburetor down into the crankcase. The air/fuel/oil mixture is needed inside to both run the engine and lubricate all the moving parts.

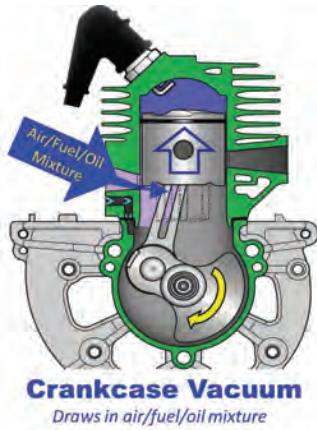

On a Piston Port 2-Stroke engine, the intake side of the piston controls air/fuel/oil mixture flow into the engine.

Compression Of air/fuel mix above piston

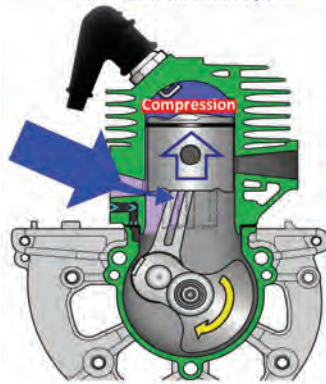

Compression (Above the piston) – At the same time air/fuel/oil mixture is entering the crankcase; the upward movement of the piston is compressing the air/fuel/oil mixture already in the combustion chamber.

DOWN STROKE

Ignition & Power (Above the piston) – Just before the piston reaches TDC; the spark plug ignites the compressed air/fuel/oil mixture in the combustion chamber. Combustion of the ignited compressed air/fuel/oil mixture causes gasses to rapidly expand forcing the piston down on the Power Stroke. Maximum combustion force is generated just as the piston starts to move down, about 5° to 10° past TDC.

Combustion Power Stroke

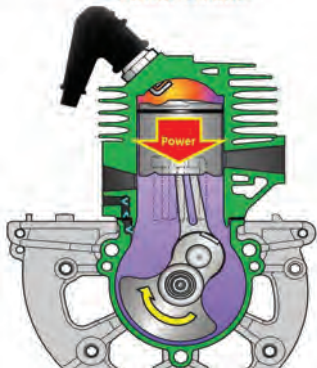

Pressurized Crankcase (Below the piston) – As the piston moves downward on the Power Stroke, the piston skirt will block the intake port. Once the intake port is blocked, the air/fuel/oil mixture trapped inside the crankcase is compressed by the downward movement of the piston.

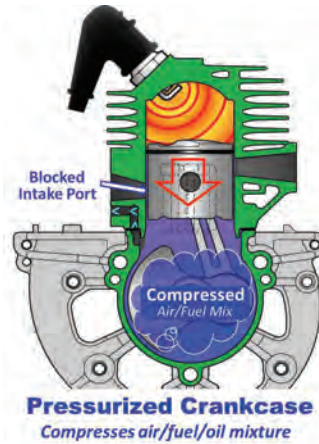

Exhaust (Above the piston) – As the piston moves down closer to BDC, the exhaust port is uncovered. Spent combustion gasses from the power stroke rush out through the exhaust port into the muffler.

Exhaust Spent combustion gasses exit

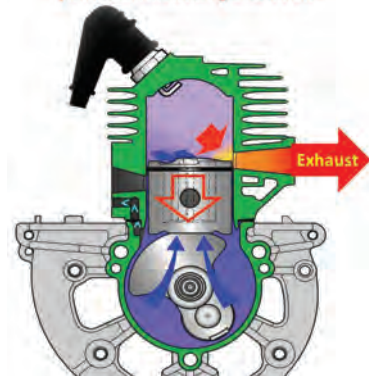

Transfer (Above & below the piston) – Near the bottom of the down stroke the transfer ports are uncovered. The fully pressurized air/fuel/oil mixture in the crankcase moves around the piston through transfer passages and into the combustion chamber. The new charge also helps to scavenge out any remaining exhaust gases from the combustion chamber.

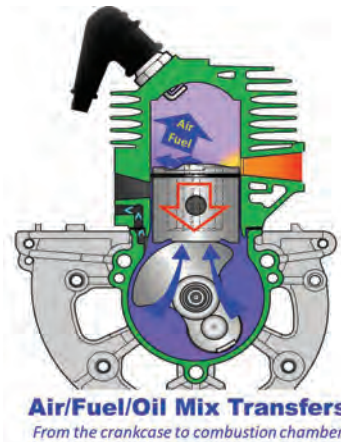

2-Stroke Engine Variations

Besides the Piston Port design, ECHO and Shindaiwa have two other 2-Stroke engine variations in the lineup. Reed Valve engines use a different method to control how the air/fuel/oil mixture enters the engine. Stratified Charge 2-Stroke engines use a different method to control exhaust emissions. These design variations do not change the basic operational theory of a two-stroke engine.

Reed Valve 2-Stroke Engines

Reed Valve Upstroke – The carburetor of a 2-Stroke reed valve engine is mounted over a reed and passageway that enters directly into the crankcase. The upstroke of the piston creates a vacuum in the crankcase that draws the reed valve open. When the reed opens, the air/fuel/oil mixture is drawn from the carburetor into the crankcase.

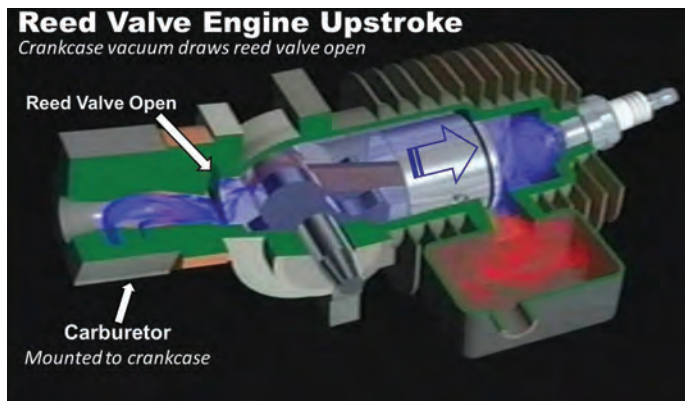

Reed Valve Down Stroke – On the down stroke the piston creates pressure in the crankcase that closes the reed valve trapping the air/fuel/oil mixture inside. The downward movement of the piston compresses the trapped air/fuel/oil mixture in the crankcase. The rest of the reed valve induction engine operating theory remains the same as other 2-Stroke engines.

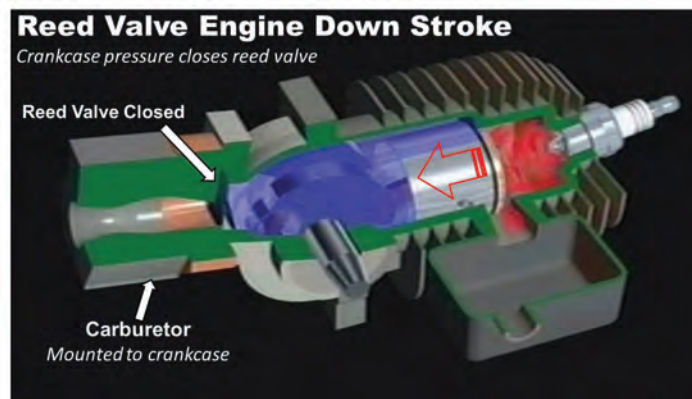

Stratified Charge 2-Stroke Engines

To improve exhaust emissions, Stratified Charge 2-Stroke engines use a short burst of raw air to help scavenge exhaust gasses out of the combustion chamber. Stratified 2-Stroke engines can meet current emissions standards without a catalyst. ECHO and Shindaiwa have modified conventional 2-Stroke engines to greatly minimize fuel loss out the exhaust and added a catalyst muffler in most cases to meet exhaust emissions.

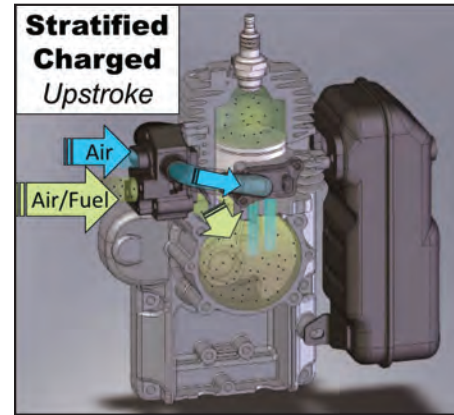

Upstroke – Stratified engines have a 2-barrel carburetor with one barrel for raw air and the other barrel for the air/fuel/oil mixture. On the engine upstroke, vacuum is created below the piston that draws raw air into the transfer port passages and air/fuel/oil mixture down into the crankcase.

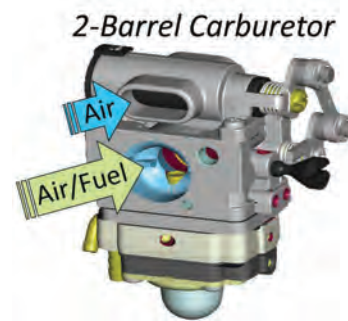

Down Stroke – Like a conventional 2-Stroke engine, the down stroke pressurizes the crankcase. When the piston opens the transfer ports, raw air in the transfer passages enters the combustion chamber first to help scavenge out the remaining exhaust gasses. The short burst of raw air is then followed by the air/fuel/oil mixture charge. Stratified Charge 2-Stroke engines can use either piston port or reed valve air/fuel/oil mixture induction. ECHO and Shindaiwa use reed valve induction on our stratified 2-Stroke engines. Basic 2-Stroke engine theory remains the same.

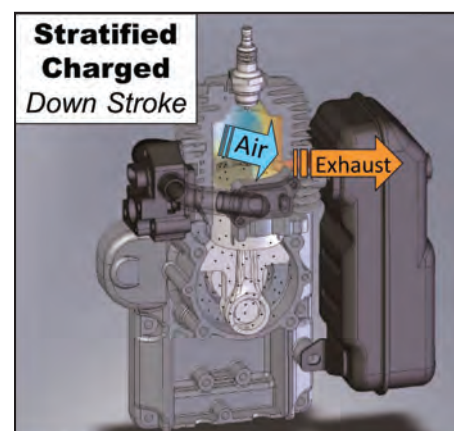

Understanding Engine Fundamentals and Basic Failure Theory can help better determine engine failure causes. Most engine failures can be broken down into three categories; excessive heat, fuel/oil mixture problems and high wear. Overheating is a factor or a byproduct in the majority of engine failures. More specifics will be covered later in the failure section of this booklet.

NORMAL ENGINE TEMPERATURES

Engines make power by the combustion of compressed air/fuel mixture that pushes the piston down in a cylinder. Temperatures can exceed 2,000° Fahrenheit (1,093° C) in the center of the combustion away from the metal. Handheld power equipment engine's pistons and cylinders are made mostly from aluminum. The melting point of aluminum is 1,221° Fahrenheit (660° C). When everything goes as designed, the cylinder and the piston surrounding the combustion chamber dissipates the heat preventing melting of the aluminum.

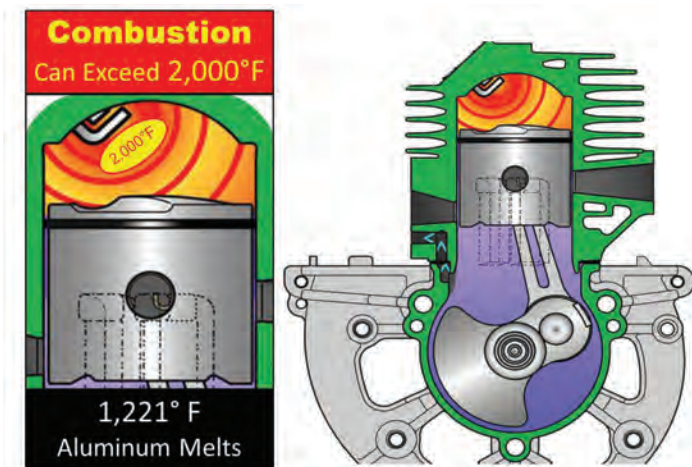

ENGINE COOLING

Cylinder Fins – To compensate for high heat, air cooled engines have many cylinder fins to dissipate the heat. More cooling fins and larger cooling fins are added to the hotter exhaust side of engines.

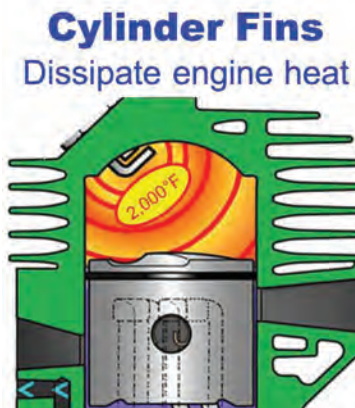

Flywheel – Another important part of engine cooling is the flywheel that forces cooler outside air over the cylinder fins.

Flywheel Forces air over engine



Air/Fuel Mixture – The incoming air/fuel/oil mixture from the carburetor is also important to help cool the engine.

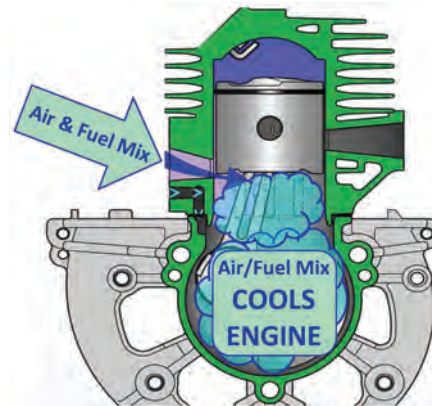

PISTON & CYLINDER CLEARANCE

Pistons must maintain a constant clearance between cylinders for long engine life. If there is too little clearance the piston will rub on the cylinder and the engine will fail. If there is too much clearance between the piston & cylinder the engine will have poor performance and higher exhaust emissions. Excessive piston to cylinder clearance may cause piston slap and will lead to shorter engine life.

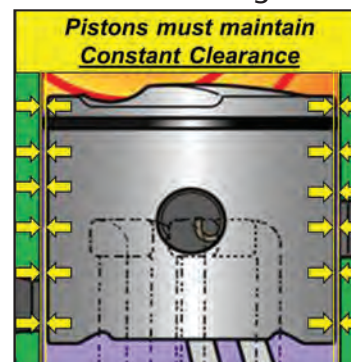

OVERHEATING FAILURES

Overheating failures result in piston and cylinder scoring caused by the piston expanding past its design limits. The expanding piston eliminates clearance and necessary oil film, until friction begins to melt the piston to the cylinder. Overheating failures are caused by a number of factors, including over-lean fuel mixture, excessive engine loads, stuck piston rings, and cooling system failures. Sometimes overheating can be caused by a combination of these symptoms.



Over-Lean Engine Conditions – Over lean means more air and less fuel is entering the engine from the carburetor. Less fuel entering the engine also means less oil enters for lubrication. Over lean conditions add to engine heat by causing extreme combustion temperatures. Less fuel mixed with incoming air from the carburetor also means less engine cooling. Over lean conditions can lead to piston scoring caused by a potent combination of less engine cooling, less lubrication and extreme combustion temperatures that cause excessive piston expansion.



Excessive Engine Loads – Excessive engine load creates more resistance for the crankshaft to turn, slowing the engine rpm down. The engine attempts to produce more power to keep the crankshaft turning causing overheating. At the same time excessive load increases heat, the slower engine rpm reduces the flywheel/fan speed reducing cooling.

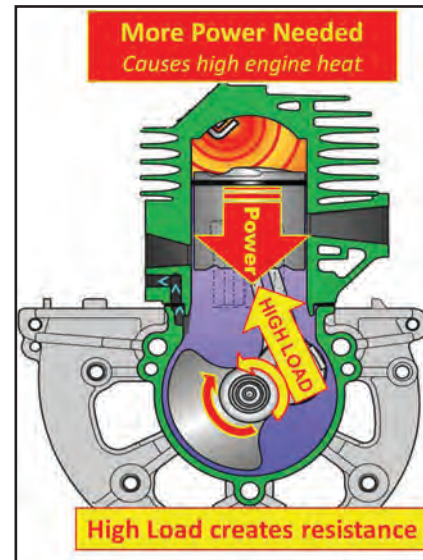

Stuck Piston Rings – Extremely hot combustion gasses will blow-by stuck piston rings down the side of the piston skirt. The blow-by will first cook lubrication off the side of the piston. If the engine continues to run with stuck rings overheating will cause scoring.



Compression Gauge

A compression test is important to establish a baseline of the engine condition before it's disassembled. For accurate readings, only use a high quality compression tester that's designed for small displacement handheld equipment engines. It must have a short small diameter hose and a gauge that reads no more the 250psi. Small displacement engines can cause automotive compression gauges to read incorrectly low.



#91037 Premium Quality Compression Gauge

Pressure/Vacuum Tester

A Pressure/Vacuum Tester is needed to check for fuel system leaks that could contribute lean seize failures. The Pressure/Vacuum Tester is also used to perform a crankcase pressure/vacuum test to check for engine air leaks that cause lean running conditions. A high volume pressure/vacuum tester works best for crankcase leak testing.



#91024 High Volume Pressure/Vacuum Tester (includes case)

Plug Adaptor & Port Block-Offs

To perform a crankcase pressure/vacuum test the spark plug must be replaced with a plug adaptor. In addition, the intake and exhaust ports must be sealed with rubber block-offs for pressure/vacuum testing. Trapezoid rubber block-offs work in most applications. Some models require special block-offs and plates shown in the ECHO & Shindaiwa Tool Catalog.



#91018 Plug Adaptor
#91041 Rubber Trapezoid Block-Offs

TOOL KIT

(*Includes most required failure analysis tools)

The Troubleshooting Tool Kit can be used to repair and troubleshoot ECHO & Shindaiwa engines as well as many competitive brands of handheld outdoor power equipment. Most of the required special failure analysis tools are included in this kit.



#91116 Troubleshooting Tool Kit with case

Distributor & Dealer Website

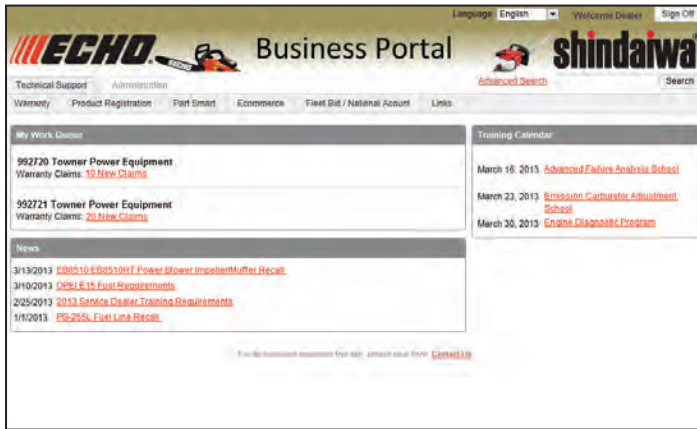

The ECHO and Shindaiwa Distributor & Dealer Website is your best choice to find up to date service information including; parts look-up, service & parts bulletins, service manuals and online training programs. There are many other service information downloads on the website including the Tool Catalog, the Quick Reference Manual and the Failure Analysis Report.

Failure Analysis Report

The front page of the Failure Analysis Report has a list of step by step checks and tests to help determine the cause of engine failures. Checks on the left side of the front page are to be made before the engine is disassembled. The right hand side of the front page lists checks to be made after the engine is disassembled. The back page has color picture examples of engine failures with a list of symptoms to look for. Laminated copies of the Failure Report can be purchased in English or Spanish from your distributor. The Failure Report can also be downloaded from the Distributor & Dealer Website.

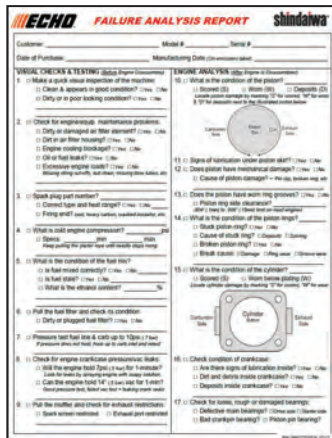

FRONT



BACK

Tool Catalog



For a complete list of special tools, see the ECHO and Shindaiwa Tool Catalog. A paper copy can be ordered from your distributor. The most current tool catalog can also be downloaded on the Distributor & Dealer Website.

Quick Reference Manual

The ECHO Quick Reference Manual (QRM) is primarily intended to look up fast moving parts but there is an engine specification section in the back of the booklet. The QRM is the quickest way to look up engine compression readings for ECHO products. Other basic engine specifications are in the manual as well.

There currently is no Shindaiwa QRM. Locate Shindaiwa engine specifications online in Service Manual Supplements.

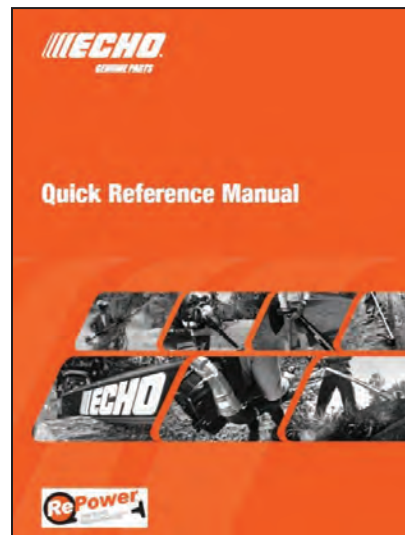

Before the engine is disassembled

MAINTENANCE

Lack of maintenance and abuse are factors in many engine failures. These problems should be diagnosed before failed engines are taken apart for inspection. First check the outside of the engine to see if it looks like it has been properly maintained and repaired. An engine that looks poorly maintained on the outside often shows damage inside the engine.



Wired on air filter cover



Check general condition

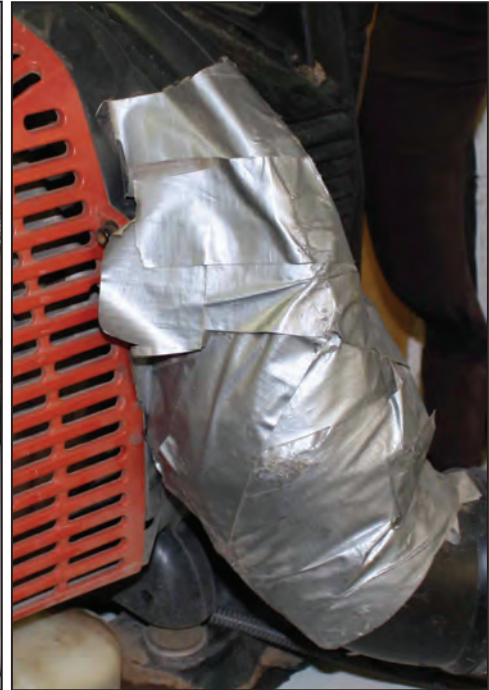

Duct tape repair

✓ **Air Filter** – Air filter maintenance is always at the top of the operator’s manual maintenance list to reduce engine wear. Inspect the air filter element to see if it’s damaged or plugged up with dirt and debris. Next, check air filter housing to see if any of the dirt and debris passed the element. The engine has likely ingested whatever is inside the filter housing.



Check air filter for dirt & debris



Check filter housing for dirt & debris

✓ **Engine Cooling Intake** – Proper engine cooling is extremely important to prevent overheating that creates excessive carbon and causes engine failure. Many ECHO & Shindaiwa engines are equipped with a loop style cooling system that uses incoming air to help cool the bottom of the engine and fuel in the gas tank. Chain saws draw engine cooling air directly through the starter housing and most backpack blowers bleed off blower fan air to cool their engines. Know where the cooling intake is at on all engines and check them for restrictions.

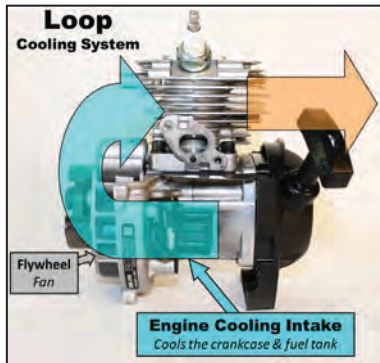

✓ **Fuel & Oil Leaks** – Examine the outside of a failed engine for fuel and oil leaks. An oil leak is a visual indication an engine may have a crankcase air leak. An air leak can cause an engine to run lean. Fuel leaks can allow air into the fuel system causing the engine to run lean. Verify where leaks are coming from by pressure testing the fuel system and crankcase.



✓ **Excessive Engine Loads** – Check for signs of excessive load that could cause engine overheating. On most models the cutting attachment is the load. For string trimmers, the load is the length and diameter of the trimmer line. When a string trimmer is used without a string shield there is no control over engine load, making engine overheating a possibility. A dull chain or an overheated guide bar could be signs of excessive chain saw engine load. Leaf blower load is controlled by the length and diameter of the blower tubes. When the end blower tube nozzle is removed it drops engine rpm and increases load.



Before the engine is disassembled**SPARK PLUG EVALUATION**

The wrong type and heat range spark plug can contribute to engine failure. Inspection of a spark plug can also give clues on engine condition and help determine why an engine failed.

✓ **Correct Type & Heat Range** – The firing end of a spark plug is constantly being bombarded with the byproducts of combustion. To prevent fouling, the center electrode insulator must get hot enough to operate in the self-cleaning temperature range between 932°F (500°C) and 1,472°F (800°C). Spark plugs exceeding 1,472°F (800°C) can ignite the air/fuel mixture in the engine before the spark plug fires causing pre-ignition engine damage. Be sure to verify a failed engine has the recommended type and heat range spark plug.

✓ **Normal Spark Plug Conditions** – The tan colored center electrode insulator you see here is what you should expect from an engine with the correct spark plug, on a well maintained engine, operating at the proper temperature, at the correct air/fuel ratio.



Normal Plug Condition

✓ **Carbon Fouled Spark Plug** – Heavy carbon build up like this can indicate heavy carbon build up inside the engine. The wrong heat range spark plug (Cold or Hot) can cause rapid carbon build up. Other contributors are using non certified (ISO L EGD or JASO FD) oils, too rich oil ratio (25 to 1) and heavy dirt ingestion.



Carbon Fouled Plug

✓ **Overheating Spark Plug** – Note the dull color of the outside of the spark plug shell and the flakes of carbon stuck to the firing end of the spark plug. Both plug conditions are signs this engine suffered from extreme operating temperatures. When you see a spark plug like this, expect to find overheating engine damage.



Overheated Spark Plug

ENGINE COMPRESSION

If the failed engine is not locked up, perform a compression test. The compression test is the best way to determine engine condition before disassembly. Current minimum recommended compression readings are as low as 80psi on some models to a minimum of 140psi on other models. Be sure to check compression specifications in the Quick Reference Manual or Service Manual Supplements before performing the test.

✓ **Perform Compression Test** – Compression is tested when the engine is cold, with the choke open and throttle at WOT. There is no set number of pulls to find your max compression, pull the engine over until the needle no longer climbs. Make sure that the needle flicks back and forth when reaching your max reading. This indicates that the Schrader valve is working properly in the tester. If your compression reading is 20% or lower than the minimum compression specifications, expect major engine damage or stuck piston rings.

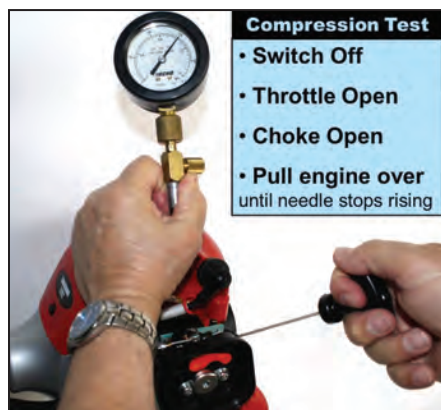

FUEL MIX CONDITION (Inspect a sample)

Whenever possible inspect a sample of the fuel mix from the tank of a failed engine. The sample may lead to clues that helps determine the cause of an engine failure. If the fuel tank is empty, try placing a clear vial under the carburetor return line and pump the purge bulb. There may be enough fuel left in the fuel line and carburetor to get a good sample.

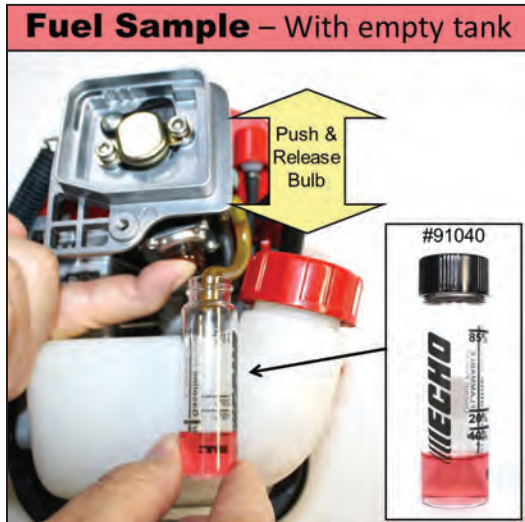

✓ **Fuel Mix Oil Presence** – Most 2-Stroke oils tint the gasoline for the operator to plainly recognize it as 2-Stroke fuel mix. Visual inspection of fuel samples can be helpful in identifying raw gas or 2-Stroke oil concentration. There are other ways to test for oil concentration. One we know that works is the Oil Presence Test from B³C Fuel Solutions.

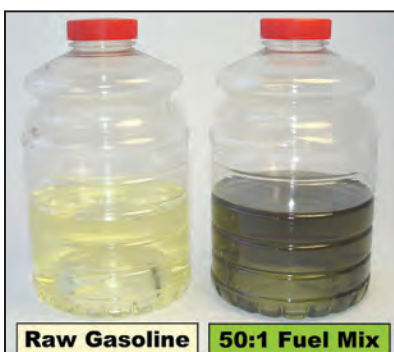

✓ **Stale Fuel** – Fuel mix that decomposes into stale fuel causes power equipment engine fuel system problems and performance problems. Stale fuel is also a major factor in engine failures. You may detect the varnish smell of stale fuel even if there is no fuel in the tank. If it's old enough, stale fuel will often turn brownish in color. B³C Fuel Solutions also has a High Sensitivity Test that does a good job of verifying stale fuel. In addition, the B³C test can detect marginal stale fuel before your nose can smell it.



✓ **Ethanol** – ECHO and Shindaiwa handheld power equipment is designed to tolerate up to 10% ethanol blended fuel. Even 10% blended fuel can have issues if it's not stored correctly. Ethanol causes fuel to turn stale sooner, beginning in as little as 30-days. In addition, ethanol absorbs moisture from poorly sealed fuel containers or open spouts. Once the blended fuel reaches its saturation point the ethanol and water can drop out of suspension with fuel/oil mix causing "phase separation". The mix oil remains with the gasoline while the ethanol/water mix drops to the bottom of the fuel tank. If the engine runs on the ethanol/water mix, a raw gas like engine seizure is possible. It's recommended you check for water in the bottom of the fuel tank of a failed engine.

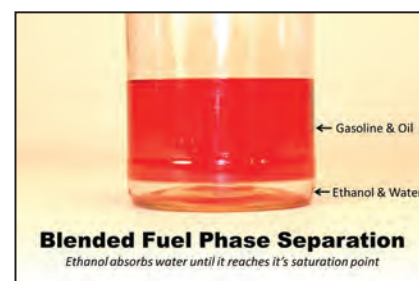

Before the engine is disassembled

E15, E20, E30 & E85 Blended Fuel – Hand-held power equipment engines can't compensate for higher concentrations of ethanol like modern automobiles. Ethanol causes engines to run leaner. ECHO and Shindaiwa engines are adjusted to run safely on up to 10% ethanol blended fuel. Higher percentage ethanol blends can contribute to lean seize failures. Current market and proposed market blends vary from 15% to 85% ethanol. In addition the actual ethanol percentage at the pump is not always consistent. It's recommended you test the ethanol percentage in a failed engine.



FUEL SYSTEM

✓ **Fuel Filter** – Check for a dirty or restricted fuel filter. Fuel filters have the outer primary filter you see and a secondary filter hiding behind the main filter. Anything that restricts fuel flow can contribute to an engine failure, even something as simple as a restrictive fuel filter.



✓ **Fuel System Pressure Test** – A fuel system pressure test will check for carburetor inlet leaks. First hook the inlet fuel line and pull it out of the fuel tank. With the inlet line out of the tank, push the purge bulb several times to flush any excess fuel out of the system. Remove the fuel filter from the end of the line, hook up the pressure tester and pump the gauge up to 10psi (.7 bar). The pressure should hold for 1-minute. If the pressure leaks down, connect the pressure tester directly to the carb inlet fitting and retest. Carburetor pressure leaks usually indicate flooding conditions that would not cause engine failure. However, inlet fuel line leaks may allow air to get into the diaphragm carburetor that could cause lean running conditions and possibly engine failure.

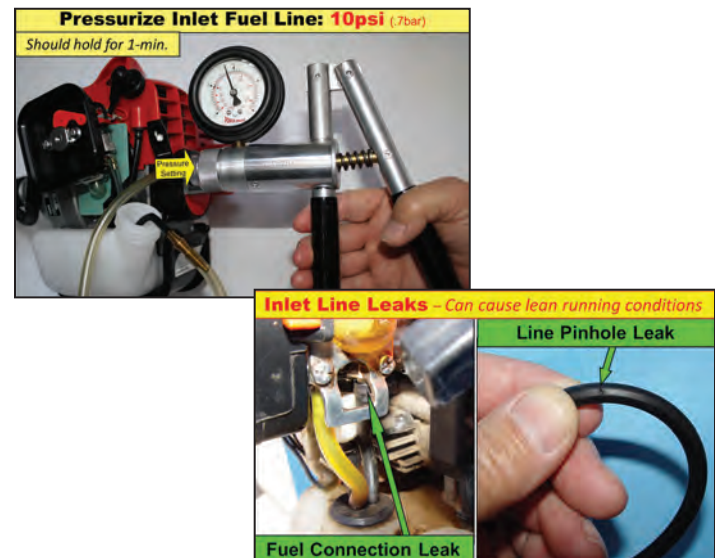

✓ **Carburetor Limiter Caps** – The most common cause of lean seize engine failures are over lean carburetor adjustments. Verify the carburetor mixture adjustment screw limiter caps are in place, if so equipped. Virtually all ECHO and Shindaiwa carburetors are fully adjustable. To ensure engines don't suffer over lean engine damage and meet EPA/CARB emissions standards, adjustments must only be done by trained technicians using correct emissions bulletins. New limiter caps must be installed once adjustments are complete. Carburetors missing limiter caps may have been tampered with, possibly contributing to engine failure. NOTE: Some ECHO and Shindaiwa carburetors do not use limiter caps. Carbs without limiter caps require the use of special tamper resistant tools to make carburetor adjustments.

CRANKCASE PRESSURE/VACUUM

Two-Stroke engines & mix lubricated 4-Stroke engines must have sealed crankcases to run correctly. Crankcase air leaks, either on the pressure or vacuum side, will cause lean running conditions. Lean running conditions caused by crankcase air leaks can contribute to lean seize engine failures.

✓ **Crankcase Pressure Test** – A cracked intake manifold, leaking engine gaskets or leaking crankshaft seals can cause crankcase air leaks. You need to rule in or rule out whether a failed engine had an air leak or not. To perform the pressure test, block off both the intake and exhaust ports. Replace the spark plug with a plug adaptor, hook up the tester, and switch it to the pressure setting. When you pump up the tester, the engine should hold 7psi (.5 bar) for 1-minute. This test is recommended on all failure examinations **BEFORE THE ENGINE IS DISASSEMBLED**.



✓ **Crankcase Leak Check** – If the tester does not hold pressure, locate the leak by spraying a soapy solution around the engine and look for bubbles.



✓ **Crankcase Vacuum Test** – A crankcase pressure test will detect many crankshaft seal leaks. However, worn crankshaft seals occasionally leak only on the vacuum side. If the engine passes a pressure test perform a vacuum test. Switch the tester to the vacuum setting. Pump the tester to 14.7 inches of vacuum (.5 bar). The engine should hold that vacuum for 1-minute. If the engine passes the pressure test but fails the crankcase vacuum test,

the crankshaft seals are leaking. Crankcase vacuum leaks will cause lean running conditions also.



EXHAUST SYSTEM

Carbon & deposits inside an engine are byproducts of the combustion process. However, excessive carbon is usually due to too much oil in the fuel, rich fuel mixtures, stale fuel, dirt ingestion and use of uncertified 2-Stroke oil. Restricted exhaust flow keeps more heat inside, raising engine temperature. The elevated temperature adds to carbon deposit production inside the engine as well. The combination of higher engine heat and increased carbon can contribute to an overheating engine failure.

✓ **Spark Screen Restrictions** – Remove the muffler outlet deflector and check for a restricted spark arrestor screen. NOTE: Many ECHO and Shindaiwa 2-Stroke engines use a catalytic muffler to meet exhaust emissions standards. The catalyst oxidizes hydrocarbons making it is extremely unlikely to see a plugged screen on catalytic muffler equipped engines.

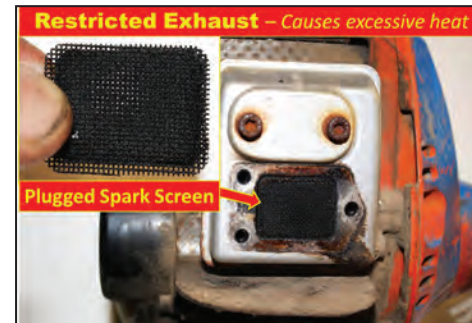

✓ **Exhaust Port Restrictions** – The exhaust port is upstream from a catalytic muffler. So, even if the spark screen looks good, it's important to pull the muffler and check the exhaust port for restrictions.

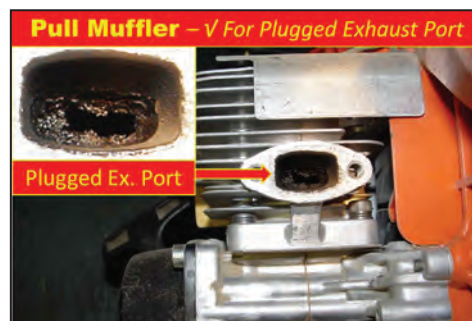

After the engine is disassembled

The cylinder must be pulled to accurately determine the cause of an engine failure. Once the cylinder is off, avoid focusing only on the engine damage. It takes very little time to make a thorough engine examination. Five components that require evaluation are the; piston, piston rings, cylinder, crankcase and the engine bearings.

CHECK FOR PISTON PROBLEMS

An internal combustion engine piston must constantly absorb the extreme heat and pressure from combustion. Conditions are tougher inside a high rpm 2-Stroke engine because there is combustion each time the piston goes up to TDC. When an engine failure occurs, the piston is often the first part that shows signs of damage. After the outside checks & tests are completed, pull the cylinder and inspect the piston for damage.

✓ **New Piston** – If you look closely you will see machine marks all around the side of a new piston. The machine marks help a new piston glide through the cylinder by reducing friction and retaining lubrication. Piston skirt machine marks begin to wear away as the engine gets more hours of running, giving clues that help determine engine wear.



✓ **Piston Wear** – Inspect the piston for wear. Look at the condition of the piston skirt machining marks to help determine the amount of piston wear. A well maintained engine with normal wear, will have light even piston skirt machine mark wear. An engine with dirt ingestion problems will quickly wear away the piston skirt machine marks, usually in an uneven pattern.



✓ **Piston Scoring** – Inspect the piston for scoring. Piston scoring is really friction welding of the piston skirt to the cylinder. Friction that causes scoring is from any combination of the following: extreme heat, or a lack of piston to cylinder clearance, or a lack of lubrication.



✓ **Piston Deposits** – Note deposits on the side of the piston. Piston skirt deposits can be a result of stale fuel, 2-Stroke oil breakdown and sticking piston rings.

✓ **Piston Mechanical Damage** – Check the piston for mechanical damage and always look for the cause of the damage. Usually piston mechanical damage is from the result of the failure of an internal engine component, like a bearing, piston pin washers or a wrist pin retainer clip.



✓ **Lubrication Under Piston** – Look underneath of the piston of a failed engine for signs of lubrication. High heat will often cook off lubrication from the outside of a failed piston. Evidence of lubrication is more likely to survive under the cooler side of the piston, especially around the wrist pin bearing.

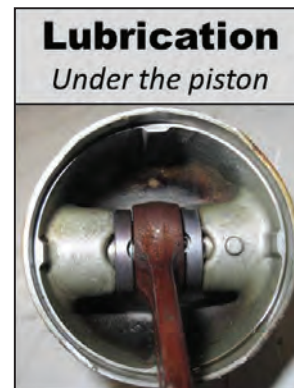

✓ **Location Of Piston Damage** – Note the location of the piston damage, it can sometimes help determine the cause of an engine failure. Piston wear, scoring, deposits and mechanical damage can be located all around the piston. The hot side (exhaust side) of the piston usually suffers the most problems but that's not always the case. For example, dirt ingestion wear is worse on the intake side of a piston port 2-Stroke engine.



CHECK PISTON RINGS

The main function of piston rings is to seal the combustion chamber, preventing hot gases from blowing by the piston into the cylinder. Secondly, rings help to transfer high combustion heat from the piston to the cylinder. When piston rings no longer seal correctly it's usually from wear or because the rings are stuck in the piston ring grooves.

✓ **Ring Groove Wear** – Check the piston ring grooves for wear. Excessive piston ring groove side clearance is one of the most common causes of piston ring breakage. Measure piston ring groove clearance by inserting a feeler gauge between the ring and groove. Most ECHO and Shindaiwa engines have a side ring clearance limit of .004 to .006 thousands of an inch. This very simple test will tell you how much the ring and piston is worn.



✓ **Stuck Piston Rings** – Check the piston for stuck rings and also note the location of the stuck rings. Stuck piston rings are engine killers. Once an engine's piston rings are stuck, the engine will fail if it continues to run. Always try to determine why the rings are stuck. The most common causes of stuck rings are deposits in the ring grooves and piston scoring.



INSPECT CYLINDER BORE

All ECHO & Shindaiwa cylinder liners are plated to resist wear and damage. The bore usually looks a little dull on new cylinders until the engine breaks in and the piston rings polishes the surface to a shiny chrome appearance.

✓ **Cylinder Score** – Check the cylinder bore for scoring and note the location of the scoring. The cylinder damage is usually in line with the damage to the piston.

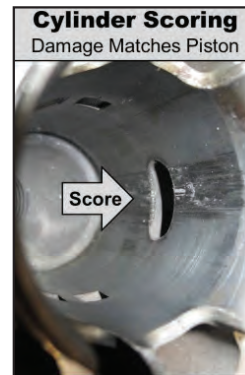

✓ **Cylinder Wear** – The cylinder is worn out when the polished shiny liner surface gets worn away exposing the dull aluminum base metal underneath. Inspect the cylinder bore for wear and note the location of the wear. Wear is most likely to occur at the top of the cylinder and around porting.



After the engine is disassembled

CHECK THE CRANKCASE

The air/fuel/oil mixture enters the crankcase first on 2-Stroke & mix lubricated 4-Stroke engines to lubricate all the moving parts and run the engine. Sometimes important evidence is left behind in the crankcase that helps determine the cause on an engine failure.

✓ **Lubrication In Crankcase** – Inspect the crankcase for any signs of lubrication inside. The crankcase runs at the coolest temperature of all major engine components. Even in high heat failures, if oil has been mixed with fuel lubrication will show up in the crankcase.

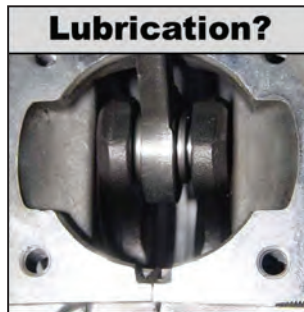

✓ **Crankcase Deposits** – Check the for signs of fuel deposits in the crankcase. A fresh fuel/oil mixture rarely breaks down and leaves deposits in the crankcase. The exception is stale fuel, which will usually leave behind brownish sticky deposits.

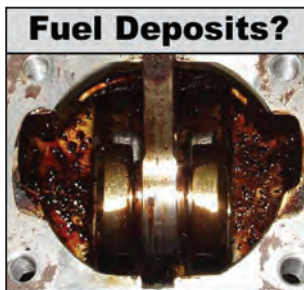

✓ **Dirt & Debris In Crankcase** – Dirt deposits inside the crankcase confirms engine dirt ingestion issues. Search the crankcase for debris anytime you have an engine mechanical failure. Pieces of failed bearings or broken pin spacer washers may be left behind.

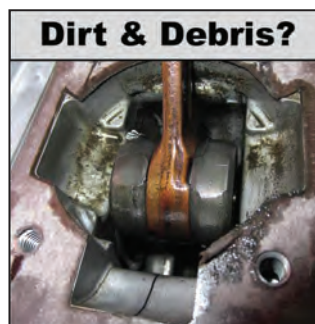

CHECK ENGINE BEARINGS

ECHO and Shindaiwa uses only high quality needle and ball bearings designed to last the life of the engine. In rare cases, when bearings do wear or fail, they can give clues to determine the cause of engine failure.

✓ **Rod Bearings** – Check the connecting rod for any up and down play. Vertical rod play usually indicates crankpin bearing failure that may account for engine mechanical damage. Side play in the big end connecting rod is normal. A small gap is needed on each side of the crankpin bearing to allow air/fuel/oil mix in to lubricate and cool it. If there is some vertical connecting rod play, verify the looseness is not caused by worn piston pin mounting bosses.



✓ **Main Bearings** – To check main bearings for looseness, grab the end of the crankshaft and see if it can be moved side to side. Main bearing failure is caused by wear or breakage of ball bearing cages.

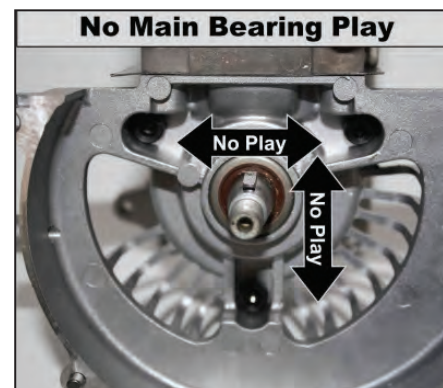

RAW GAS FAILURE CAUSE

The cause of a raw gas failure is simple. It involves running a 2-Stroke engine or a mix lubricated 4-Stroke engine on gasoline without any 2-Stroke oil.

OUTSIDE ENGINE RAW GAS SYMPTOMS

No 2-Stroke Oil In Fuel Sample – Suspect the engine has been run on raw gas if an engine fuel sample is fairly clear and not tinted a color. If possible, test the fuel sample. The B³C Fuel Solutions Oil Presence Test works well. If the fuel tank is empty, use the purge bulb to pump fuel remaining in the carburetor into a small clear vial for a visual inspection.

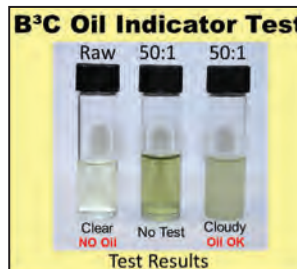

Engine Locked Up or Low Compression – Severe piston scoring will often cause an engine run on raw gas to be locked up. If the engine is not locked up, chances are the compression is low because scoring has stuck the piston rings.

INSIDE ENGINE RAW GAS SYMPTOMS

Scoring Around Most of Piston & Cylinder – Without lubrication, friction creates heat that causes the piston to expand in all directions. Raw gas piston & cylinder damage usually results in a heavy exhaust score with scoring likely around the rest of the piston & cylinder. Sometimes raw gas scoring may even occur over the cooler intake port side of a piston port engine.

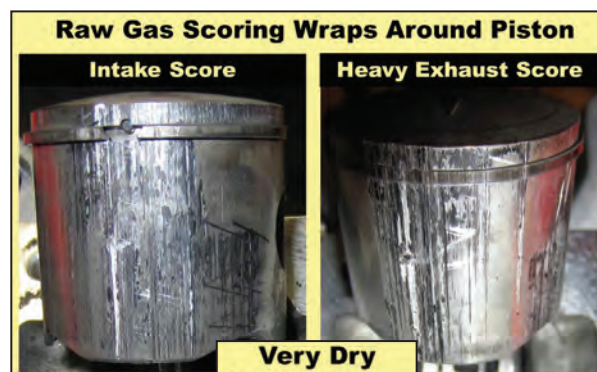

Outside of Piston Very Dry – The top of the piston, piston skirt and rings will all look very dry when an engine fails on raw gasoline.

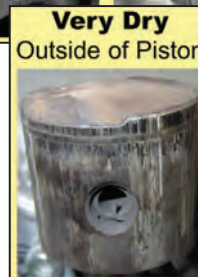

Raw Gas Won't Cause Bearing Failure – All ECHO and Shindaiwa crankshaft/connecting rod components ride on low friction needle and ball bearings. Raw gas will almost always cause piston and cylinder failure before engine bearings are damaged.

May Be Dry Under Piston & In Crankcase – If an engine runs long enough on raw gasoline, it may wash away signs of lubrication under the piston and inside the cooler crankcase. Sometimes raw gas residue will dry up several minutes after pulling the cylinder. If raw gas causes the engine to quit running or lock up fairly quickly, residual lubrication may still be in the crankcase and under the piston.

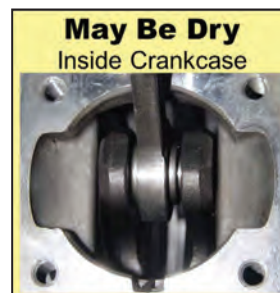

Ethanol & Water Phase Separation – Phase separation engine failures look similar to raw gas failures. Phase separation is caused when ethanol and water drops out of suspension with gasoline. The ethanol water combination falls to the bottom of the gas can/fuel tank, while the gasoline/oil mix floats to the top. When an engine runs on an ethanol/water mix, the lack of oil will cause the engine to fail like raw gas.

RAW GAS FAILURE REVIEW

Always try to verify an engine has run on raw gasoline by inspecting and testing a fuel sample. Many engine failures produce exhaust side piston scoring, but a raw gas failure produces scoring all around the piston. Consider raw gas as a possible cause of failure whenever scoring continues from the exhaust side of the piston around to the intake port side of a piston ported engine. If there is a significant amount of water in a fuel sample, it's possible a raw gas failure could be caused by ethanol/water phase separation.

DIRT INGESTION FAILURE CAUSE

Poor air filter maintenance is the most common cause of dirt ingestion. When dirt enters an engine, it forms a grinding compound that prematurely wears all moving parts, particularly the piston, piston rings and cylinder. By far, the most common cause of premature engine wear is dirt ingestion.

OUTSIDE ENGINE DIRT INGESTION SYMPTOMS

Dirty Air Filter & Air Filter Housing – Look for a dirty or damaged air filter element. Remember, as the air filter plugs up a high rpm engine creates a constant vacuum inside the air filter housing. Eventually the plugged element will cause enough air filter housing vacuum to pull dust through the filter media. Dirt inside the air filter housing is proof that the engine has inhaled dust.

Low Engine Compression – Evidence of dust in the air filter housing combined with a low engine compression reading* are the early clues that an engine has suffered a dirt ingestion failure. *Minimum compression specs vary. Check service information.

Dirt Carbon In Exhaust Port – Dirt forms carbon during combustion that fuel and oil solvents can't remove. It's common to see heavy carbon in the exhaust port on dirt ingestion failures. Sometimes this carbon is tan in color.

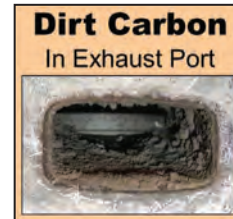
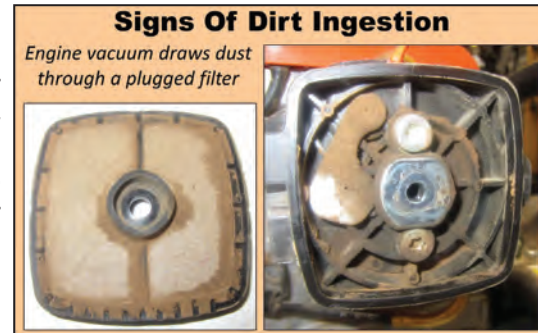

INSIDE ENGINE DIRT INGESTION SYMPTOMS

Dirt Carbon On Piston Top – Dirt forms scaly carbon deposits, sometimes tan in color, on top of the piston and in the top of the cylinder.



High Piston Wear

Piston Port Engines – All sides of the piston begin to prematurely wear when an engine is inhaling dust. The piston intake side wears quicker on a piston port engine because all air, fuel, oil and dust enters the engine through the intake port.



High Piston Wear

Reed Valve Engines – Dirt ingestion piston wear is more even on a reed valve induction engine. Reed valve engines have no intake port. All air, fuel, oil and dust enters directly into the crankcase. Sometimes more piston wear occurs in line with the transfer ports, because that is where the dirty mixture transfers from the crankcase to the combustion chamber.



INSIDE ENGINE DIRT INGESTION SYMPTOMS (Continued)

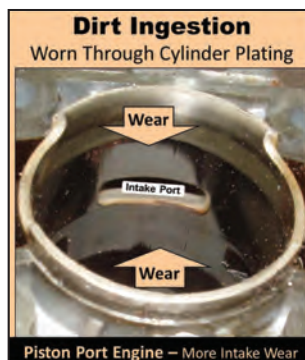

Piston Groove Wear – One of the main causes of premature piston ring groove wear is dirt ingestion. Sloppy ring grooves create excessive side clearance that causes piston rings to pound back and forth with each firing of the combustion charge.

Piston Ring Wear & Ring Breakage – Most ECHO and Shindaiwa piston rings have beveled corners. Dirt ingestion wears the rings thinner, eliminating the beveled corners. The thinner rings have square sharp edges that can more easily snag cylinder ports. The major cause of broken piston rings is worn rings and worn piston ring lands.

No Piston Skirt Deposits – Typically, dirt ingestion gives piston skirts a sandblasted look with no deposits on the sides of the piston.

Cylinder Wear

Piston Port Engines – Premature cylinder bore wear below the plating is likely caused by dirt ingestion. On piston port engines, excessive cylinder wear above and below the intake port is a sure sign of dirt ingestion. This high intake side cylinder and piston wear can increase carburetor spit back on piston port engines. Excessive carb spit back can soak the air filter with fuel.

Cylinder Wear

Reed Valve Engines – Cylinder wear is more even on reed valve induction engines because they have no intake port. There may be more wear above the cylinder transfer ports.

Worn Engine Bearings – Dirt ingestion usually wears out the piston, piston rings and cylinder before engine bearing wear occurs. However, if the engine runs long enough with dirt ingestion problems prematurely worn bearings are possible. The connecting rod big end bearing and drive side main bearing are most susceptible to wear out.

Crankcase Dirt Deposits – Dirt deposits inside the crankcase are evidence of dirt ingestion.

DIRT INGESTION REVIEW

Dirt ingestion causes premature piston skirt wear, high piston ring wear and ring land wear. Suspect dirt ingestion anytime the plated cylinder liner is prematurely worn through to the base metal. Expect to find dirt deposits inside the crankcase and excessive carbon deposits in the combustion chamber and exhaust port. Dirt ingestion causes piston port engines to wear more on intake side of the piston and cylinder.

LEAN SEIZE FAILURE CAUSE

Modern outdoor power equipment engines must run more efficiently and therefore leaner to meet EPA & CARB exhaust emissions. This means today's engines are more susceptible to lean seize failures. Lean seize failures are caused by extreme combustion temperatures generated by either too little fuel or too much air entering the engine.

OUTSIDE ENGINE

Over Lean Carburetor Adjustments – The over lean adjustments delivers less fuel into the engine dramatically increasing combustion temperatures. Less fuel also means less oil is going into the engine to lubricate it. It's critical that adjustments be made per the service bulletin to meet emissions and to ensure there is enough fuel going into the engine. After adjustments, limiter caps must be installed if so equipped. If the carburetor is missing limiter caps and the engine has lean seize symptoms, a misadjusted carb could be the cause.

Other Lean Condition Causes – Lean seize failures can also be caused by anything else that reduces fuel flow into the engine.

Fuel Restrictions – Reduced fuel flow can be caused by a restricted fuel filter, debris inside the carburetor, a carb stiff metering diaphragm or problem fuel pump diaphragm flapper valves.

Leaking Inlet Fuel Line – Lean running conditions could also be caused by air getting into the carburetor from a pin hole leak in the inlet fuel line. Perform a fuel system pressure test to confirm a leak.

Too Much Air Entering The Engine – Lean seizures can be caused by any problem that lets too much air into the engine. Typical engine air leaks include, leaking crankshaft seals and leaking engine gaskets. A loose carburetor mounting block is another example of an air leak. Always perform a crankcase pressure/vacuum test before a failed engine is disassembled to check for air leak problems.

Low Engine Compression – Lean seize failures will usually cause piston scoring that pins the rings creating low engine compression*.

* Minimum compression specs vary. Check service information.

Over Lean Carb Adjustments

A cause of lean seize failures



Other Lean Condition Causes

Dirty Fuel Filter



Debris In Carburetor



Stiff Diaphragm



Engine Air Leaks

Cause Lean Conditions



Leaking Seals



Leaking Gaskets

INSIDE ENGINE

Top Of Piston With Burnt Color – A lean seize failure often show signs of extreme combustion temperatures with a burnt look to the top of the piston.

Extreme Combustion Heat

Piston Top – Burnt Color



Piston Score Over Exhaust Port



NO Damage On Rest of Piston



NO Piston Skirt Deposits

Exhaust Score Will Expand

If engine continues to run

Heavy Exhaust Side Score



NO Damage To Rest of Piston



Lubrication Will Remain

Under Piston & In Crankcase



Over Speeding Bearing Failure

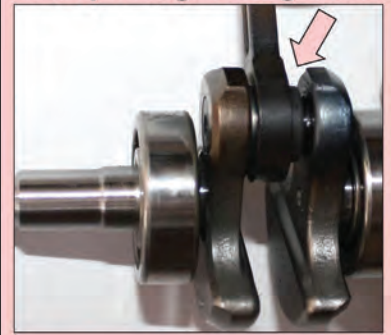

INSIDE ENGINE (continued)

Exhaust Side Piston Score – Extreme combustion heat from over lean fuel mixture causes rapid expansion of the piston toward the exhaust port. The piston expansion leads to metal to metal contact with the cylinder, resulting in scoring concentrated over or near the exhaust port.

Little Damage To Rest Of Piston – Typically, lean seize failure scoring is confined only over the exhaust. The rest of the piston will usually look fine. Heat expansion can cause a small intake side piston score 180° opposite the exhaust side damage, but lubrication on the cool side of the engine will usually prevent intake side scuffing.

No Piston Skirt Deposits – Lean seize failures occur rapidly, leaving little time for oil to breakdown and bake onto the piston. As a result, lean seize failure piston skirts usually remain clean.

Large Exhaust Score Possible – Lean seize exhaust side scoring will expand if the engine continues to run with stuck piston rings. Despite the heavier exhaust score, the rest of the piston usually will remain clean and undamaged.

Piston Rings Free Except At Score – Lean running conditions don't cause piston ring land deposits. Piston rings stay free in their grooves except at the site of the exhaust side score.

Cylinder Scoring Matches Piston Damage – Lean seize failure cylinder scoring will match exhaust side piston damage.

Lubrication Under Piston & In Crankcase – Lean seize failures will leave signs of lubrication behind in the cooler parts of the engine, like inside the crankcase and under the piston.

Engine Over Speeding – Lean mixture running conditions can help to increase engine speeds above recommended rpm. Sustained extreme engine rpm can cause bearing failures. The big end connecting rod bearing is most likely to fail because centrifugal force slings off lubrication. Models with light engine loads, like hedge clippers, are most susceptible to have high rpm bearing failures. Chain saws are also vulnerable to bearing problems if the operator regularly runs the saw out of the cut.

LEAN SEIZE REVIEW

Lean seize failures are caused by either not enough fuel or too much air going into the engine. Too little fuel entering the engine can be caused by over lean carburetor adjustments, dirty fuel filters, stiff carb metering diaphragms or debris inside the carb. Too much air going into the engine is caused by leaking engine gaskets and crankshaft seals. Over lean running conditions create extreme combustion temperatures that cause localized scoring of the piston over the exhaust port. The rest of the piston typically will have no scoring or deposits.

OVERHEATING FAILURE CAUSE

Extreme engine heat is a FACTOR in most engine failures. However, overheating as the PRIMARY CAUSE of engine failures is limited mostly to blocked engine cooling, high engine loads, and restricted exhausts. A combination of these issues can cause overheating failures.

Blocked Engine Cooling Intake



Blocked Cylinder Fins



OUTSIDE ENGINE OVERHEATING SYMPTOMS

Blocked Engine Cooling – Always check a failed engine for a blocked engine cooling air intake and blocked cylinder fins. Even though it is clearly covered in the owner's manuals, most operators have no idea about checking and cleaning the engine cooling system for blockage.

Loop Cooling Air Intakes – Air intake blockage can be easily overlooked on many models when the intake is between the crankcase and fuel tank.

Blower Fan Intake Blockage



Backpack Blower Air Intakes – Most backpack blowers use blower fan air to cool the engine. Leaf blockage of the fan intake grid reduces engine cooling and can cause blower engine overheating failure. Most often leaves will fall off the intake grid when the engine is shut off, leaving no proof of the blockage. Keep this in mind when looking at blower internal engine damage that looks like an overheating failure.

Heavy Engine Load
No String Shield



High Engine Load
Worn Clutch Shoes



Heavy Engine Load – Look for signs of high engine load including missing string shields on string trimmers, dull chain & damaged guide bars on chain saws, and missing end tubes on blowers. High loads lug the engine down creating more engine heat. At the same time heat increases, slower rpm means slower flywheel speed and less cooling air for the engine.

High Load (Worn Clutch) – Badly worn clutch shoes indicate clutch slippage. Overloading the engine is one of the most common causes of clutch slippage.

Restricted Exhaust – Increases Engine Heat



Restricted Spark Screen



Partially Plugged Exhaust Port

Restricted Exhaust – Partially plugged spark screens and exhaust ports raise internal engine temperatures and create more carbon inside the combustion chamber. NOTE: On catalyst muffler equipped models the spark screen will stay clean while the exhaust port can become blocked.

Overheated Spark Plug

Indicates engine overheating symptoms



Overheated Spark Plug – Most ECHO and Shindaiwa engines are equipped with NGK spark plugs that have a shiny plated metal shell. If the spark plug is the correct type and heat range, it's normal for the metal shell to tarnish a little with use. Extremely high engine heat changes the shell of NGK plugs to a dull gray color. This is a sure indicator that the engine was over heated.

Seized Engine or Low Compression – Over heating engine failures can have severe scoring and stuck piston rings. If the engine is not locked up, it's likely the stuck rings will cause low compression.

INSIDE ENGINE OVERHEATING SYMPTOMS

Oil Breakdown Deposits On Piston

Early Stages of Oil Breakdown – Identifying piston skirt oil breakdown deposits helps to distinguish engine overheating failures from many other failures. Extreme piston heat will cause even good quality 2-Stroke oil to bake deposits on the side of the piston. In the early stage of overheating, oil breakdown will show up around the exhaust side of the piston.

Oil Breakdown Early Stage



Later Stages of Oil Breakdown – Overheating creates abnormally high temperatures all around the piston. So, oil breakdown deposits will spread around most of the piston if the cause of the problem continues. The piston oil deposit layer will become thicker as long as the rings stay free and the engine continues to run. As the oil deposits build, they form a heat dam that reduces combustion heat transfer from the piston to the cylinder.

Oil Breakdown Late Stage



NOTE: Normal running conditions can breakdown uncertified 2-Stroke oil inside hi-rpm air cooled 2-Stroke engines. Verify operator use of certified 2-Stroke oil. (Meets ISO-L-EGD & J.A.S.O. FD standards)

Scoring Spreads Around Most Of Piston – Overheating cooks off lubrication, enlarges the piston in all directions, reducing clearance with the cylinder. If the engine continues to run with an overheating problem, friction will cause piston scoring. The scoring will continue to spread around the piston, each time the engine is restarted with an overheating problem.

Overheating Scoring Spreads Around Piston



Exhaust



Side

Cylinder Scoring Matches Piston Scores – Typically, overheating oil breakdown deposits form only on the piston, not the cylinder. Overheating cylinder scoring will match the location of the metal transfer from the piston.

**Piston Port Engine
No Intake Scoring****Stuck Piston Ring
Overheating Oil Breakdown****OUTSIDE ENGINE OVERHEATING
SYMPTOMS (Continued)**

Scoring Unlikely Over Intake Port (Piston Port Engine)
– It's unlikely overheating piston scoring will occur over the cooler intake port of a piston ported engine.

Stuck Piston Rings – Extreme heat forms oil breakdown deposits in ring grooves, making stuck piston rings common in overheating failures. Combustion blowing by the stuck rings will terminate any engine that has continued to survive with overheating problems.

Lubrication Remains In Crankcase – Overheating oil breakdown occurs only in the top end of the engine at the piston and cylinder. Signs of lubrication will remain inside the cooler crankcase of the engine.

OVERHEATING REVIEW

Outside The Engine – Extreme heat is part of most engine failures, however overheating engine failures are primarily limited to blocked air cooling intakes, blocked cylinder fins, engine overloading, and restricted exhaust. Try to confirm the outside engine overheating cause before diagnosing an overheating failure.

Inside The Engine – Inside the engine, excessive heat causes 2-Stroke oil to breakdown and form deposits around the sides of the piston. Oil breakdown deposits also form in ring lands, causing piston rings to stick. Overheating symptoms cause the entire piston to expand, causing scoring if the engine continues to run. Scoring will proliferate around most of the piston depending how long the engine runs with overheating problems.

Conclusion – Most engine overheating failures take a long time to occur. For example: Debris gradually builds up blocking engine cooling, baking oil deposits onto the piston. Each time the engine runs more cooling blockage occurs, more heat is generated and ever thicker deposits form on the piston. Eventually the cumulative effect of the oil deposits and the increasing heat cause the piston to seize.

DETONATION FAILURE CAUSE

Normal Combustion – During normal combustion the spark plug ignites the air/fuel mixture just before Top Dead Center (TDC) because it takes time for the mixture to burn. Just past TDC, heat expands the trapped gases inside the combustion chamber, creating high pressure that begins pushing the piston down. The crankshaft converts the vertical energy from the piston into rotational power.

Detonation – During detonation the spark plug fires at the correct time; just before TDC on the compression stroke. The ignited air/fuel mixture begins spreading normally outward away from the plug. If heat or pressure becomes too high for the octane rating of the fuel, the remaining air/fuel charge in the combustion chamber can spontaneously combust. The separate combustion fronts will collide at or near TDC, creating a destructive spike in combustion pressure that can produce 2~3 times the normal load on engine components. It's important to note detonation occurs AFTER the normal firing of the spark plug.

Gasoline Octane Rating – ECHO and Shindaiwa recommends use of a good quality 89 octane (mid-grade or higher) gasoline containing no more than 10% ethanol. The higher the octane number allows fuel to withstand more heat and combustion pressure before detonating. Using higher octane fuel is like buying insurance against engine problems that cause detonation; like lean fuel mixtures, high engine loads and combustion chamber carbon build-up.

ENGINE DETONATION SYMPTOMS

Detonation Failure Causes – Both over lean fuel mixtures and excessive engine loads dramatically increases combustion temperature, which can lead to detonation. Over lean fuel mixtures can be caused by lean carburetor adjustments, engine air leaks, or anything else that restricts fuel flow into the engine. Engine over loading can be caused by missing trimmer shields, dull saw chain, missing blower end tubes, etc. A combination of over lean fuel mixtures and high engine loads can cause detonation.

Piston & Cylinder Damage – Detonation will often cause what appears like erosion damage at the top of the piston above the exhaust port. That "erosion" is actually melting of the piston caused by the extreme heat of detonation. Detonation pressure spikes can break pistons, break ring lands, damage bearings and even break cylinder mounting flanges. Detonation damage is most likely to occur on larger handheld 2-Stroke engines around 50cc or larger.

Piston Detonation Damage



PRE-IGNITION FAILURES

As the name implies, pre-ignition results in firing a portion of the combustion charge BEFORE the normal ignition by the spark plug. The pre-ignition air/fuel mixture charge is ignited by hot spots in the combustion chamber; usually a glowing piece of carbon or a glowing spark plug. Since the air/fuel mixture fired early, combustion pressure starts to build while the piston is moving up on the compression stroke, before it gets to TDC. Pre-ignition results in extreme combustion heat.

Pre-Ignition Failure Causes – Pre-Ignition causes include using a spark plug with too high of a heat range, combustion chamber carbon build-up, blocked engine cooling and lean running conditions. Pre-ignition can be identified by the engine continuing to run when the ignition switch is turned off. The engine can only be stopped by blocking off the air supply to the engine.

Pre-Ignition Piston Damage – In the final stages of pre-ignition extreme heat can cause melting of the piston. Sometimes a hole is melted through the piston. Pre-ignition failures are rare because detonation usually precedes pre-ignition. Most often, the destructive forces that cause detonation already caused engine failure before pre-ignition occurred. When pre-ignition failures do occur, it's usually on models with larger engines like backpack blowers and chain saws (50cc or more).

Pre-Ignition Hole Melted Through Piston



STALE FUEL FAILURE CAUSE

Like many products, gasoline has a shelf life. Ethanol blended fuel has a shorter shelf life. Gas can begin to turn bad in as little as 30-days, depending on how it is stored. As fuel gets old the most volatile components start to oxidize and what's left behind decomposes into new compounds like acetic acid. Acetic acid is what gives stale fuel that awful varnish smell. If there is enough volatility left in the stale fuel to run the engine, varnish deposits can build inside causing engine failure.

Preventing Stale Fuel Problems – The best way to avoid stale fuel problems is to purchase gasoline from a reliable supplier, use only modern self-venting fuel storage containers with “no spill” self-sealing spouts, and use the fuel up within 30-days. Premium ECHO and Shindaiwa 2-Stroke oil contains fuel stabilizers that can help keep fuel fresh up to 90-days when properly stored. The stabilizers in Red Armor 2-Stroke oil can help keep fuel fresh up to 2-years when properly stored. Another option is to add a name brand fuel stabilizer at the pump. Fuel stabilizers are only effective if mixed with fresh fuel and then properly stored. Remember that nothing will properly rejuvenate old, stale fuel.

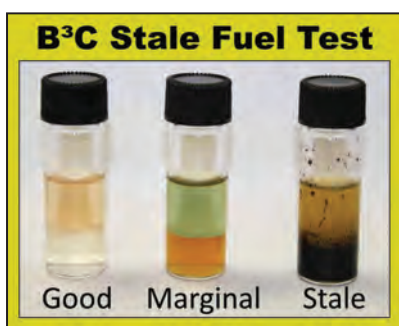

OUTSIDE ENGINE STALE FUEL SYMPTOMS

Fuel Sample Smells Like Varnish or Tests Stale –

The distinct varnish smell coming from a fuel sample is the first clue an engine failure may be caused by stale fuel. In the later stages stale fuel will turn brownish in color. When possible, test the fuel sample to confirm it's stale. The B³C Fuel Solutions Oxidation Test works to determine if fuel has turned stale, including detecting stale fuel problems before it starts to smell bad.



Varnish Smell & Brown Deposits In Fuel Tank –

Even if there is no fuel in the tank, stale fuel will leave the varnish smell behind. Stale fuel often leaves brown sticky deposits behind inside the fuel tank.

Deteriorated Fuel System –

Stale fuel is one of the most common causes of fuel system failures. Stale fuel can cause the fuel filter to turn brown, fuel lines can turn hard, carburetor metering diaphragms to turn stiff and curling of the fuel pump diaphragm check valves.



Locked Up Engine –

Stale fuel varnish deposits can stick the piston in the cylinder and prevent engine bearings from turning. If the engine is not locked up engine compression may be OK. Varnish deposits fill the piston to cylinder gap, providing some short term sealing.

INSIDE ENGINE STALE FUEL SYMPTOMS

Varnish Deposits On Piston Skirt – Stale fuel can form varnish deposits throughout the entire inside of the engine. Friction and heat will cause stale fuel to quickly bake deposits onto the sides of the piston. The amount of these deposits is determined by how bad the gas is and how long the engine runs on stale fuel.

Stuck Piston Rings – As varnish deposits stick to the piston skirt, they also stick inside piston ring grooves. Stale fuel quickly causes rings to stick all the way around the piston.

Varnish Deposits Inside Crankcase – All air/fuel/oil mix enters the crankcase first of a 2-Stroke engine. Stale fuel mix doesn't fully vaporize inside the crankcase leaving sticky varnish deposits behind. In most other engine failures, deposits are rare inside the cooler engine crankcase. A key factor in identifying stale fuel failures are varnish deposits inside the crankcase.

Varnish Deposits Inside The Cylinder – As the air/stale fuel/oil mixture moves from the crankcase up to the combustion chamber, varnish deposits will stick inside the transfer ports. Piston heat and friction will cause stale fuel to stick to the cylinder walls as well.

Varnish Deposits Under Piston – The longer the engine runs on stale fuel the more likely varnish deposits will cook under the piston.

Piston Scoring Possible – Often stale fuel varnish deposits will cause a piston to stick to the cylinder, causing an engine to lock up before scoring occurs. However, if the engine continues to run with stuck rings scoring is likely.

Piston Varnish
Stuck Piston Rings



Crankcase Varnish

Varnish Under Piston



Scored Piston
If engine continues to run



STALE FUEL REVIEW

When gasoline is stored past its shelf life it can begin to decompose, forming new compounds like harmful varnish deposits. Un-stabilized fuel can begin to turn stale in as little as 30-days. Proper gasoline storage is important.

Outside The Engine – Stale fuel produces a distinctive varnish smell and may turn brownish in color. When possible, test a fuel sample to confirm gas is stale. Stale gas deteriorates fuel system components and plugs fuel filters.

Inside The Engine – An engine that starts and runs on stale fuel will quickly begin to form varnish deposits inside the engine crankcase. Deposits will spread to the piston and cylinder. Running an engine on stale fuel often causes piston rings to stick. Stale fuel can cause piston and cylinder scoring if the engine continues to run with stuck rings.

Key Identifying Factor – Sticky engine crankcase varnish deposits are a major factor in identifying stale fuel failures. Most other failures don't produce varnish deposits inside the cooler crankcase.

UNCERTIFIED 2-STROKE OIL FAILURE CAUSE

High rpm emissions compliant air cooled 2-Stroke engines require fuel mix oil designed for this application. ECHO and Shindaiwa requires operators only use 2-Stroke oil that meets or exceeds the following independent standards: ISO-L-EGD (ISO/CD 13738) and J.A.S.O. FD. Two-Stroke oil not meeting manufacturer certification can cause deposits to build up on the sides of the piston, stick piston rings, and can cause excessive combustion chamber/exhaust carbon. Scoring is possible if the engine continues to run with stuck rings.

AIR COOLED 2-STROKE OIL BASIC REQUIREMENTS

Lubrication – Two-Stroke oil must provide an adequate film of lubrication for all moving parts. **Short term**, most 2-Stroke oils on the market can provide enough lubrication at normal engine operating temperatures and engine loads.

Temperature Limits – The additive package in uncertified oil may not be good enough to protect air cooled 2-Stroke engines at higher temperature limits. **Long term**, high temperatures can cause uncertified oil to breakdown and lose its lubricity.

Engine Deposits – Since 2-Stroke oil is consumed in the combustion chamber with gasoline, the oil's additive package must minimize the formation of engine deposits. **Over time**, uncertified oil builds up combustion chamber and exhaust carbon deposits that can contribute to engine failure.

2-STROKE OIL STANDARDS

NMMA – NMMA standards are for water cooled outboard boat motors and personal watercraft. NMMA TC-W3 rated oil should not be used in any emissions certified air cooled high rpm 2-Stroke engines.

API – API is well known for automobile and truck motor oil ratings, but when you see an API-TC rating on 2-Stroke oil it's really a marketing gimmick. Outdated API 2-Stroke oil standards have not been improved since 1993 and API stopped monitoring 2-Stroke oil certifications that same year.

ISO & JASO – The current best 2-stroke oil you can use in high rpm air cooled 2-Stroke engines is oil that meets or exceeds the ISO L-EGD & JASO FD standards. These are the only standards recommended by ECHO and Shindaiwa.

ECHO & SHINDAIWA 2-STROKE OIL

ECHO PowerBlend X® and Shindaiwa ONE® – PowerBlend X and Shindaiwa ONE oils are a blend of synthetic and petroleum base oil with a quality additive package that improves performance, reduces deposits, and extends the life of air cooled 2-Stroke engines. On top of that, a fuel stabilizer is added to the oil that helps to keep fuel mix fresh for up to 3-months.

Red Armor™ ECHO and Shindaiwa Oil – ECHO & Shindaiwa's premium Red Armor 2-Stroke oil takes engine protection to the next level. It has an additive package unlike any other product on the market and a fuel stabilizer that protects for up to 2-years. Many engine failures are caused by internal engine deposits and use of Red Armor 2-Stroke oil is one of the best ways to prevent deposit build up. The detergent package in Red Armor oil not only helps prevent deposit build up in new engines, it actually removes deposits/varnishes/carbon from older engines.

ECHO PowerFuel™ – ECHO PowerFuel is ready-to-use right out of the can. PowerFuel contains 93 octane, ethanol free gasoline, pre-mixed at a 50:1 ratio with Red Armor oil. PowerFuel is a high performance fuel that has all the engine cleaning benefits of Red Armor oil, including the fuel stabilizer that helps keep fuel fresh up to 2-years.

2-Stroke Oil Standards			
NMMA	API	ISO	JASO
FC-W 4-Stroke Oil	TB		FA Retired in 2005
TC-W3 2-Stroke Oil	TC Inactive in 1993	L-EGB	FB
BOATS ONLY	DEAD RATING	L-EGC	FC
		L-EGD The Best	FD The Best

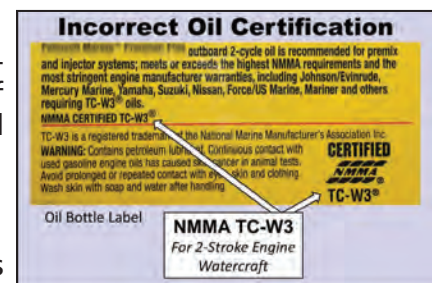



Verify Oil Is For Hi RPM Air Cooled 2-Stroke Engines

– Before accusing an operator of an uncertified oil engine failure, always try to verify the oil being used meets high rpm air cooled 2-Stroke engine certification requirements. This is because uncertified oil breakdown symptoms can look very similar to other failure problems, like overheating.

JASO Registration Code

– The operator’s oil bottle should have I.S.O. L-EGD certification and a J.A.S.O. **FD** registration code.

If the bottle has no JASO code number, one should be available from the oil manufacturer. Without a JASO registration code there is no assurance JASO standards are really being met.



Oil Breakdown With NO Overheating Symptoms

– Be suspicious of the operator’s fuel mix oil when you see piston oil breakdown deposits without signs of engine cooling system blockage or engine overloading. Typically uncertified oil will work fine and not leave any deposits in the cooler crankcase of the engine.

Piston Skirt Deposits

– Uncertified oil breakdown deposits often spread around most of the piston. Since extreme engine heat is not a factor, a 2-Stroke engine may continue to run a long time on an uncertified oil fuel mixture. More layers of uncertified oil breakdown deposits will build as long as the rings stay free and the engine continues to run.



Stuck Piston Rings

– Uncertified oil breakdown deposits will also build inside piston ring grooves causing rings to stick. These oil deposits collect all around the piston, often causing rings to stick all the way around as well.

Piston & Cylinder Scoring Possible

– Since uncertified oil deposits form at normal engine temperatures, overheating isn’t an early problem. Gradually layers of deposits will continue to build, reducing piston heat transfer to the cylinder, causing overheating.

Piston and cylinder scoring is possible caused by a combination of high heat cooking off lubrication, excessive piston expansion and stuck piston rings.

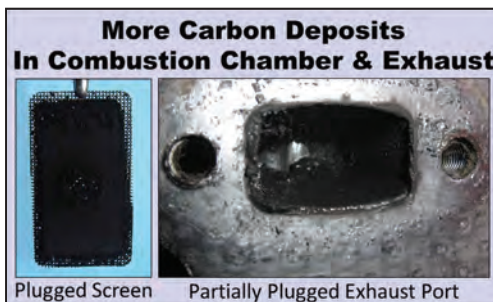

Combustion Carbon Build Up

– Additives in quality certified 2-Stroke oil minimize carbon build up when the air/fuel/oil mixture is burned in the combustion chamber. Uncertified 2-Stroke oil can build excessive carbon deposits on top of the piston, in the exhaust port and on the spark screen. Exhaust restrictions can cause excessive engine heat.

UNCERTIFIED 2-STROKE OIL FAILURE REVIEW

Uncertified Oil Failure Symptoms – Oil not certified for high rpm air cooled 2-Stroke engines can cause oil breakdown deposits around piston, stuck piston rings and heavy combustion chamber/exhaust carbon build up. Uncertified oil breakdown can occur within an engine’s normal temperature operating range. Piston scoring is possible if the engine continues to run with stuck rings.

Preventing Uncertified Oil Failures – Uncertified oil failures can be prevented by using ECHO or Shindaiwa 2-Stroke oil or oil that truly meets or exceeds ISO L-EGD or JASO FD certifications.

Diagnosing Uncertified Oil Failures – Uncertified oil engine failures can look similar to other failures, like overheating. Before diagnosing an uncertified oil failure, confirm the engine has no overheating symptoms and verify the operator is not using oil certified for high rpm air cooled 2-stroke engines.

MECHANICAL FAILURE CAUSE

Mechanical failure is usually caused by an internal part coming loose inside a running engine. If the engine is fairly new it's likely the failure is caused by a defective part or a factory assembly error. When an internal part breaks on a well-used engine, the mechanical failure is often caused by wear.

Broken Needle Bearing**OUTSIDE ENGINE MECHANICAL FAILURE SYMPTOMS**

Locked Up Engine or Low Compression – Catastrophic damage can occur inside a high rpm engine when a part comes loose. Mechanical failure often causes the engine to lock up or sometimes the crankshaft will rotate only a short distance. If the engine does turn over, expect low compression caused by damage sticking the piston rings.

INSIDE ENGINE MECHANICAL FAILURE SYMPTOMS

Damaged Piston & Cylinder – Mechanical failures on 2-Stroke engines often causes piston and cylinder damage in line with transfer ports. Loose debris inside the crankcase is drawn through transfer passages as the air/fuel/oil mixture charge moves towards the combustion chamber. There's a good chance the loose part will get jammed between the piston and cylinder. If the debris makes it to the combustion chamber, it will damage the top of the piston & cylinder or gouge into the exhaust port. It's important to look for the failed part that caused the damage. The most common causes of mechanical failure are listed below:

Broken Wrist Pin Spacer Washer

Damage over transfer port



Broken Washer caused by wear

Bearing Failures – Needle bearings and bearing cages on both ends of the connecting rod can fail, damaging the piston and cylinder. Check for any vertical rod play and look for missing needles or broken bearing cages. Crankshaft main ball bearing cages can break as well. Confirm main bearing failure by checking for crankshaft side play. If the engine is like new, suspect a defective bearing. If the engine is used, check for engine wear or signs of over speeding.

Broken Wrist Pin Spacer Washers – Wrist pin spacer washers are added to most engines on each side of the wrist pin bearing. Spacer washers help prevent wrist pin bearing wear into the softer aluminum piston. The washers

Wrist Pin Clip Came Out (Assembly Error)

Pin Clip Lodged Into Cylinder

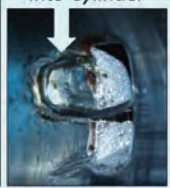

also help to align the connecting rod for proper crankpin bearing clearance. Wear, often caused by dirt ingestion, is the most common cause of spacer washer failure. Look for broken or missing spacer washers, especially if there is damage to the side of the piston over the transfer ports.

Wrist Pin Retaining Clips Come Out – Improperly installed wrist pin retaining clips can come out and jam between the piston and cylinder. When you see damage to the side of a piston, look for a missing pin clip. Technicians should always carefully install wrist pin clips when doing engine work to prevent failures.

MECHANICAL FAILURE REVIEW

Mechanical engine failures are almost always caused by an internal engine part breaking or coming loose. Debris inside the crankcase moves through the transfer passages, often causing damage to the sides of piston and cylinder over the transfer ports. If failed parts make it to the combustion chamber, damage can occur to the top of the piston, the top of the cylinder or the exhaust port.

Common Mechanical Failure Components – The most common causes of mechanical damage are bearing failures, broken wrist pin spacer washers or wrist pin retaining clips that come out. If the engine is new the problem is likely caused by a defective part or an assembly error. Check for engine wear problems when mechanical failures occur on well used engines.

ENGINE FAILURE REVIEW

So far this booklet has covered a number engine failures, each with a neat list of symptoms to help identify the cause of every failure. In the real world engine failure causes are not always that easy to identify. Sometimes there may be a combination of problems that cause an engine to fail. In addition, many failure symptoms look similar, especially when the rings are stuck and piston scoring occurs. Around 80% of the time the symptoms line up accurately with the failure cause. The best chance at determining an accurate cause of engine failure comes from using all the outside and inside engine checks in this booklet. At the very least, a full engine evaluation can narrow down the cause of failure.

COMBINATION ENGINE FAILURES

Combination Failures (Outside Engine Checks) – Often there is more than one cause of an engine failure. This 1-year old commercially used Shindaiwa hedge clipper still ran but had a rattling noise inside the engine. Before the engine is disassembled it's important to look on the outside of the machine for clues that might determine why the engine failed. The melted spot on the muffler shield indicated the engine was running hot. A check of the engine cooling intake revealed it was almost completely blocked with debris.

Combination Failures (Inside Engine Checks) – Oil breakdown deposits all around the piston was evidence of overheating inside the engine. There was also a slight score on the exhaust side of the piston. Excessive side ring clearance of .013" indicated high engine wear. The side ring clearance limit for this engine is only .006". A check of the connecting rod bearings revealed the wrist pin was loose in the piston. The worn wrist pin bosses were the source of engine noise. Excessive engine wear was likely caused by high operating hours and some dirt ingestion. Although the air filter housing was fairly clean, this hedge clipper was being operated in a dry Southwestern U.S. city and there were signs of dirt in the crankcase.

Combination Failures (The Causes) – It's likely the accurate diagnosis of both the overheating failure and high wear failure would not have been made without doing the thorough list of engine checks.

STUCK PISTON RINGS

Stuck Rings Caused By Scoring – Extreme heat causes piston scoring that welds over the ring, sticking it in the groove. High heat failures that causes scoring to stick rings are raw gas, lean seize and overheating failures. If scoring caused the ring to stick, pry a portion of a ring out and it should be relatively clean inside the groove.

Stuck Rings Caused By Deposits – Combustion deposits can fill piston grooves causing the rings to stick. Here's where it gets tricky. If the engine continues to run with stuck rings combustion will blow-by the rings causing the piston to overheat and score. The most likely cause of piston rings stuck by deposits are too much oil in fuel mix, stale fuel, uncertified oil and rich fuel mixtures. Overheating can also contribute to combustion deposits in ring grooves. If the rings are stuck by deposits, peel a portion of a ring out and there should be deposits in the groove.

Stuck Rings & Piston Scoring – Once piston rings are stuck and the piston scoring begins many engine failures can look alike. Knowing if piston rings are stuck by scoring or deposits can help narrow the cause of failure down. However, the combination of stuck rings and piston scoring increases the importance of doing the full list of inside & outside engine failure checks.

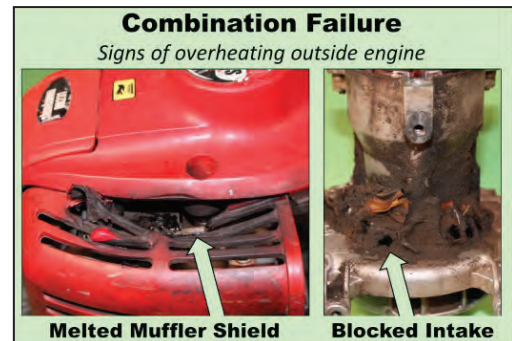

MIX LUBRICATED 4-STROKE ENGINES

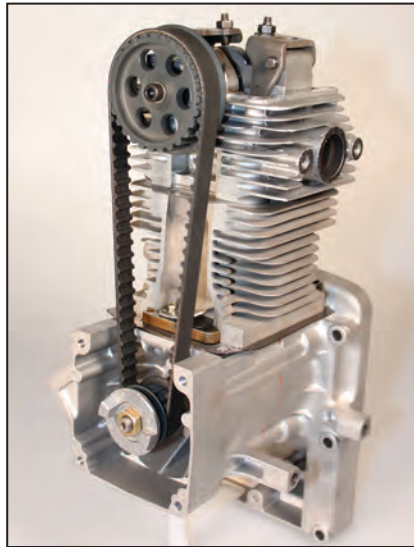

79.7cc Belt Drive Overhead Cam Engine



24.5cc Pushrod Overhead Valve Engine

Advantages – Shindaiwa introduced the first production **mix lubricated 4-Stroke engines** for handheld equipment in 2001. The design combines 4-Stroke & 2-Stroke engine technologies to produce powerheads that have excellent exhaust emissions & less noise like 4-Stroke engines with lighter weight & unrestricted all position running like 2-Stroke engines.

Engine Design – Shindaiwa utilizes both a belt drive overhead cam design and a pushrod overhead valve engine design. Since these engines are lubricated with 2-Stroke fuel mix, the crankcase is small and lightweight. **Mix lubricated 4-Stroke engines can rev over 10,000 rpm, so the piston assembly, connecting rod and crankshaft are built like hi-rpm 2-Stroke engines.** These engines have high speed needle bearings on both ends of the connecting rod and ball bearings on both ends of the crankshaft.



Built like a hi-rpm 2-Stroke engine

Basic Mix Lubricated 4-Stroke Engine Operation – The basic operating principles of a mix lubricated 4-Stroke engine are the same as any 4-Stroke engine. The 4-Stroke engine crankshaft makes two revolutions during the intake, compression, power and exhaust strokes. The air/fuel/oil mixture induction of a Shindaiwa mix lubricated 4-Stroke engine works like a 2-Stroke engine. All air/fuel/oil mixture enters the crankcase first to run and lubricate the engine.

Four-Stroke engines produce a power stroke every other revolution of the crankshaft.

MIX LUBRICATED 4-STROKE ENGINE OPERATION INTAKE STROKE

(Down Stroke)

Above The Piston – The piston moves down in the cylinder on the intake stroke creating a vacuum inside the combustion chamber. The intake valve opens on the intake stroke and the exhaust valve stays closed. Air/fuel/oil mixture from the crankcase is drawn through the open intake valve into the combustion chamber.

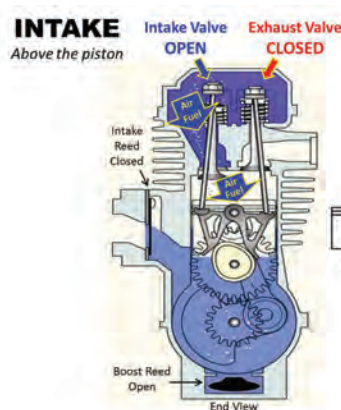

Below The Piston – The air/fuel/oil mixture induction of a Shindaiwa mix lubricated 4-Stroke engine works like a 2-Stroke engine. Each time the piston moves down in the cylinder it creates pressure in the crankcase. Air/fuel/oil mixture trapped in the crankcase is forced under pressure up to the intake valve. The pressurized air/fuel/oil mix charge is then forced into the combustion chamber as soon as the intake valve opens.

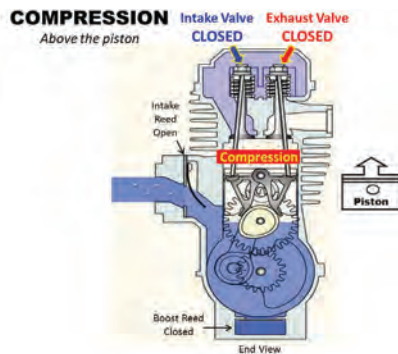
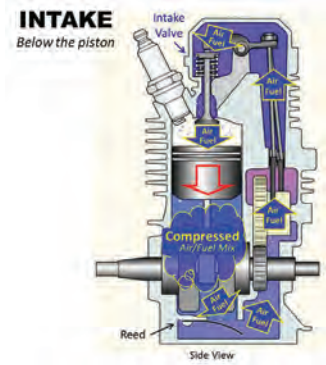

COMPRESSION STROKE (Upstroke)

Above The Piston – The piston moves up on the compression stroke with both the intake and exhaust valves closed. Air/fuel/oil mixture trapped in the combustion chamber is compressed as the piston continues to move up.

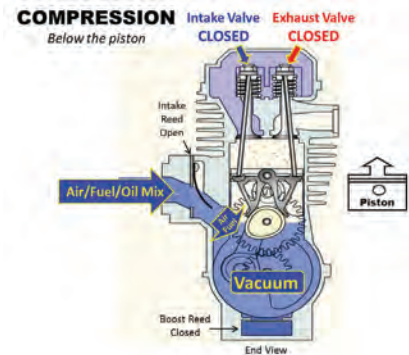

Below The Piston – Each time the piston moves up in the cylinder vacuum is created inside the crankcase. Crankcase vacuum opens the intake reed valve drawing the air/fuel/oil mixture from the carburetor down into the bottom end of the engine. NOTE: Overhead cam mix lubricated 4-Stroke engines use piston port air/fuel/oil mixture induction.

POWER STROKE

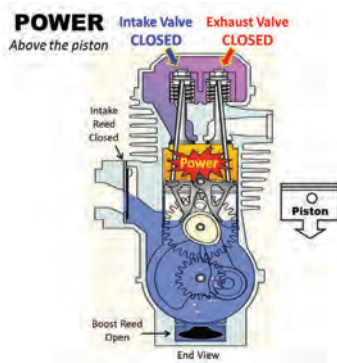

Above The Piston – Both valves remain closed. The spark plug ignites the compressed air/fuel/oil mixture inside the combustion chamber just before TDC. Just past TDC the maximum force of controlled combustion drives the piston down on the power stroke.

Below The Piston – The down stroke pressurizes the crankcase jamming the air/fuel/oil mixture into a chamber toward the intake valve. A Power Boost reed valve closes at the bottom of the power stroke to prevent the pressurized mixture from leaking back into the crankcase.

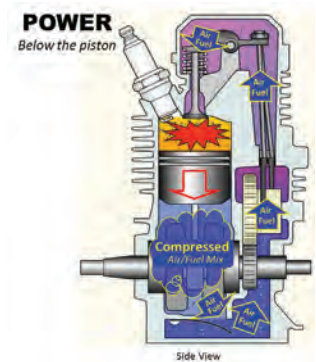

EXHAUST STROKE

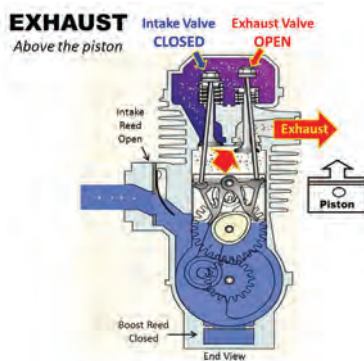

Above The Piston – On the exhaust stroke, the piston moves up in the cylinder pushing spent gases out of the combustion chamber through the open exhaust valve and into the muffler.

Below The Piston – As the piston moves up in the cylinder vacuum is created again inside the crankcase. Crankcase vacuum opens the intake reed valve drawing more air/fuel/oil mixture from the carburetor down into the bottom end of the engine.

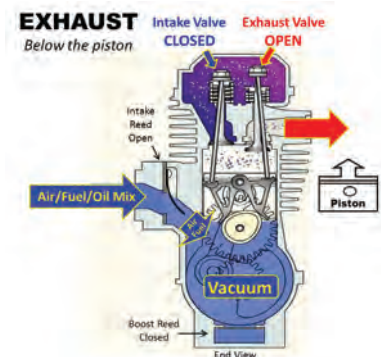

SPECIAL TOOLS **(Mix Lubricated 4-Stroke)**

Mix lubricated 4-Stroke engines are built much like 2-Stroke engines and share most of the same diagnostic tools as 2-Stroke engines. Several special tools needed to service mix lubricated 4-Stroke engines are included in the #91102 Shindaiwa Tool Kit. All tools in the kit can be purchased separately. For details on all tools, download the ECHO and Shindaiwa Tool Catalog on the Distributor and Dealer Website.



#91102 Shindaiwa Service Tool Kit

OUTSIDE ENGINE CHECKS & TESTS **Before the engine is disassembled**

Most failure analysis outside checks and tests for mix lubricated 4-Stroke engines are the same as those used on 2-Stroke engines. This section will only point out 4-Stroke engine check differences and tests unique to mix lubricated 4-Stroke engines.

✓ ENGINE COMPRESSION

10mm Gauge Adaptor Required – Mix lubricated 4-Stroke engines are equipped with special 10mm threaded spark plugs. Test compression using the ECHO/Shindaiwa #91037 Compression Gauge. Remove the standard compression gauge hose with 14mm plug adaptor and install the #91074 Compression Gauge Hose with 10mm plug adaptor.

Compression Test Procedures – Compression test procedures are the same as 2-Stroke engines: Test only cold engines. Turn the ignition switch off, open the throttle & choke, and keep pulling the starter rope until the gauge needle stops rising. Pushrod engines have a built in compression release. To get accurate compression readings on pushrod engines, be sure to pull the starter rope briskly to overcome the compression release. The belt drive overhead cam engines do not have a compression release.

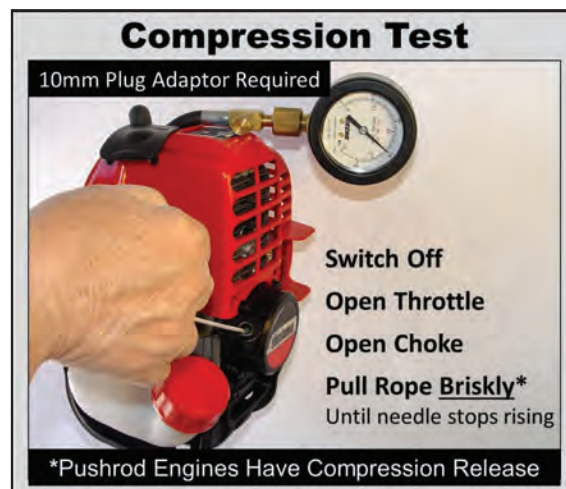

✓ CYLINDER LEAK DOWN TEST

If a mix lubricated 4-Stroke engine has low compression, a cylinder leak down test will help diagnose whether the leakage is an exhaust valve, intake valve or the piston rings and cylinder.

Special Tools – To perform this test you will need a leak down tester equipped with a 10mm spark plug adaptor (not sold by ECHO or Shindaiwa). Pictured is a #5609 OTC Tester available from independent tool suppliers. You will also need a starter pulley removal tool to hold the piston in place (#91083* for pushrod engines or #91084* for overhead cam engines). *Both starter pulley tools are included in the Shindaiwa Tool Kit.



Performing A Leak Down Test – To perform the test, remove the rocker arm cover, position the piston at top dead center on the compression stroke, and hold the piston in place with the starter pulley remover tool. Slowly apply 90 psi to the combustion chamber. TAKE CARE, the starter pulley wrench might want to move once you start applying air pressure. Combustion chamber leakage over 10% may affect engine performance. Leakage over 20% indicates major problems with the valves or piston and cylinder.

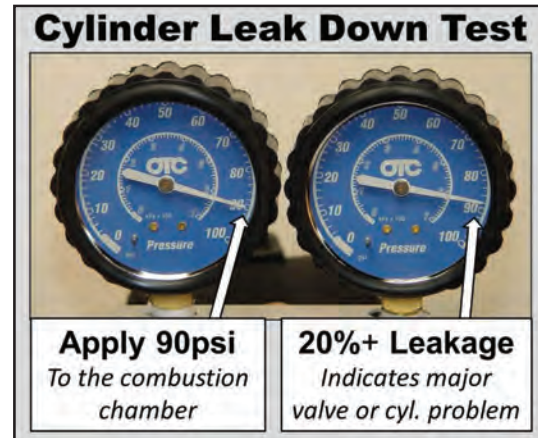

Leak Down Test Results – Air leakage out the muffler outlet indicates exhaust valve leakage. Air leakage out of the intake valve port in the rocker arm area, indicates intake valve leakage. Air leakage out of the carburetor on the overhead cam engine indicates piston and cylinder leakage. Pushrod engines have an intake reed valve preventing piston/cylinder leakage out the carburetor. On pushrod engines, check for piston/cylinder problems by checking for air leakage out of the pushrod tubes in the rocker arm area.

✓ CRANKCASE PRESSURE/VACUUM

A mix lubricated 4-Stroke engine must have a sealed crankcase to draw the correct air/fuel/oil mixture into the crankcase. A crankcase air leak will cause lean running conditions, increase engine heat and build more combustion chamber carbon. Because 4-Stroke engines fire every other revolution of the crankshaft, lean seizures & overheating failures are less likely to occur on mix lubricated 4-Stroke engines. A crankcase pressure/vacuum test is still recommended because air leaks can contribute to engine failure.

Pressure/Vacuum Test Procedure – Use the same 2-Stroke engine pressure/vacuum test procedures on mix lubricated 4-Stroke engines. To perform the test you will need to install the smaller #91081 (10mm) pressure plug adaptor. The adaptor is included in the Shindaiwa Tool Kit. Remember, leaks around the valve cover or cam cover are also crankcase air leaks.

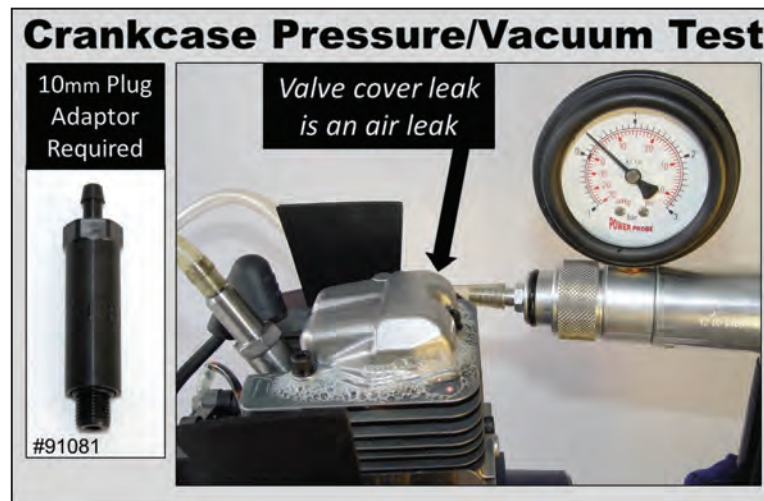

✓ VALVE CLEARANCE

Check the valve clearance. Valve adjustments are recommended every 135 hours of use. Excessive valve clearance is an indication of high wear or poor maintenance. Long term excessive valve clearance can lead to valve train failure.



INSIDE ENGINE CHECKS

After the engine is disassembled

Four-Stroke engines have a power stroke every other revolution of the crankshaft, so expect to see less overheating engine damage and less piston scoring engine failures compared to 2-Stroke engines. However, mix lubricated 4-Stroke engines can have valve train failures. High rpm mix lubricated 4-Stroke engines are designed similar to 2-Stroke engines. Most inside engine checks and tests are the same as 2-Stroke engines. Only valve train engine checks are covered in this section.

✓ CHECK FOR CAM WEAR OR DAMAGE

Mix lubricated 4-Stroke engines operate in similar engine rpm ranges as 2-Stroke engines (7,000rpm to 10,000rpm). Shindaiwa 4-Stroke engine camshaft lobes are designed to last the life of the engine. However, cam lobes can suffer from wear or damage from long term excessive valve clearance, dirt ingestion and valve stem deposits. Closely inspect cam lobes for any problems. On pushrod engines, check the nylon cam gear and metal compression release counter weight for any damage.

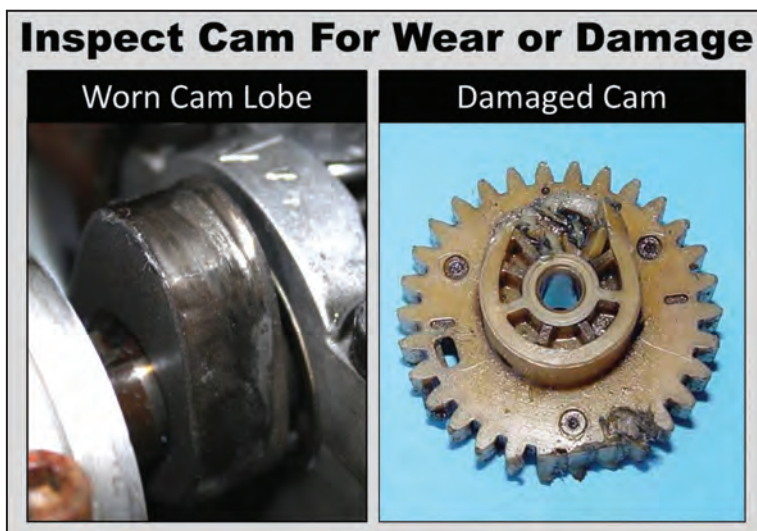

✓ CHECK VALVES FOR DEPOSITS & DAMAGE

Check valve faces and stems for deposits that can indicate maintenance problems. Valve stem deposits can cause sticky valve operation, increasing the load on cam lobes. Excessive valve clearance causes valves to really take a pounding at high engine rpm. It's pretty rare to see a broken valve but when it occurs, excessive valve clearance is the usual cause.

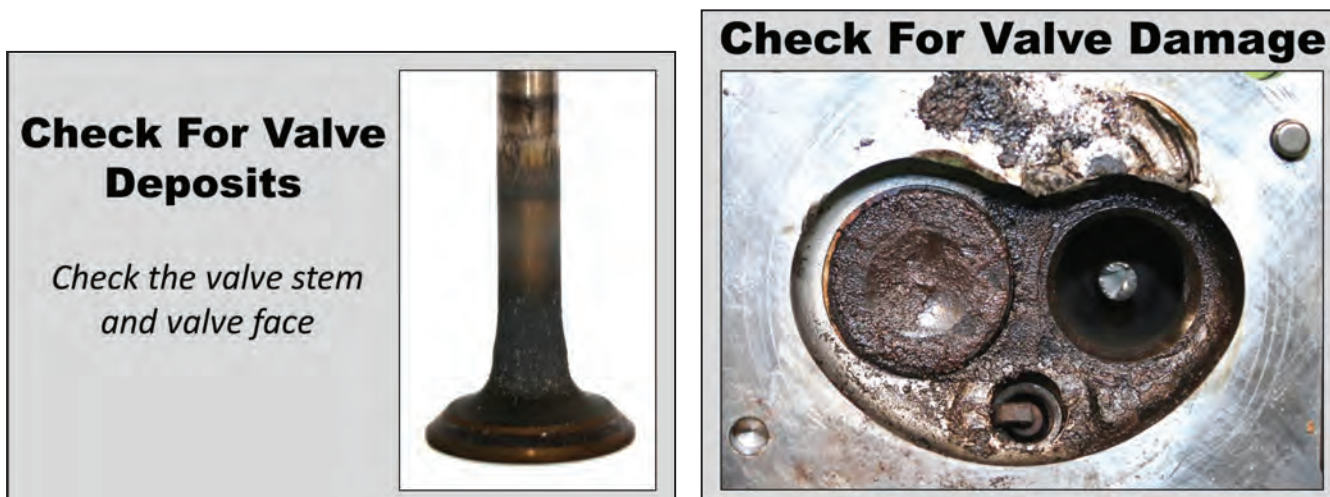

MIX LUBRICATED 4-STROKE DIRT INGESTION FAILURE CAUSE

High rpm mix lubricated 4-Stroke engines are susceptible to the same kind of dirt ingestion wear to pistons, rings and cylinders as 2-Stroke engines. The difference is that dirt also causes 4-Stroke engine valve component wear and causes valve deposits. In fact, dirt ingestion valve train failures are more common in mix lubricated 4-Stroke engines than dirt ingestion piston/cylinder failures. As with all engines, poor air filter maintenance is the most common cause of dirt ingestion failures.



Dirty Air Filter & Air Filter Housing – To prevent dirt ingestion failures all current models with mix lubricated 4-Stroke engines have dense foam pre-filters and heavy duty main filters. No matter how good these air filter systems are, some dust will pass through poorly maintained, plugged up and damaged filters.

Low Engine Compression – Evidence of dust in the air filter housing combined with a low engine compression reading are the early clues that an engine has suffered a dirt ingestion failure. A cylinder leak down test will help determine where the leakage is at.

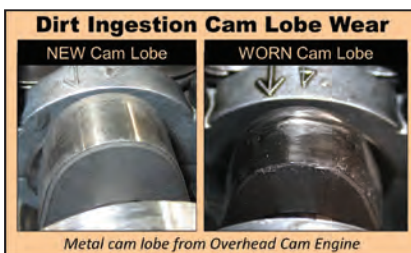

INSIDE ENGINE DIRT INGESTION SYMPTOMS

Cam Lobe Wear – Always inspect the cam lobe for wear before pulling the cylinder or cylinder head. Premature cam lobe wear is most likely caused by dirt ingestion. Lobe wear results in excessive valve clearance.

Combustion Chamber Dirt Carbon – Dirt forms scaly carbon deposits, sometimes tan in color, on top of the piston and on the top of the cylinder.

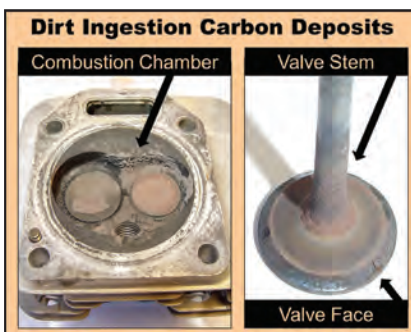

Valve Deposits – Valve deposits can be caused by many things including, uncertified oil, rich fuel mixture, stale fuel and dirt. An engine that has evidence of dirt ingestion will usually have valve deposits. Valve face carbon prevents the valve from sealing. Valve stem deposits can restrict movement of the valve in the valve guide and sometimes stick valves open.

High Piston, Rings & Cylinder Wear – Dirt ingestion will cause piston skirt wear, ring groove wear and piston ring wear on both 2-Stroke and 4-Stroke engines. High wear can lead to internal damage to the piston and cylinder. Mix lubricated 4-Stroke engines have plated cylinder liners. Once wear extends through the lining, the cylinder will need to be replaced.



Valve Train Problems Cause Most Failures – Mix lubricated 4-Stroke engines are more likely to suffer dirt ingestion valve train failures than dirt ingestion piston or cylinder failures.

Melted Nylon Cam Lobes – Valve stem deposits cause sticky valves that put extra load on valve train components. This extra load can cause melted nylon cam lobes on pushrod engines.

MIX LUBRICATED 4-STROKE DIRT INGESTION REVIEW

Dirt ingestion causes cam lobe wear, resulting in excessive valve clearance that can develop into valve component breakage. Dirt carbon valve deposits can cause poor sealing or sticky valves that can damage nylon cam lobes. Dirt ingestion typically causes more valve train issues than piston and cylinder damage on mix lubricated 4-Stroke engines.

4-STROKE RAW GAS FAILURE CAUSE

Mix lubricated 4-Stroke engines require a 50:1 ratio of gasoline mixed with 2-Stroke oil to lubricate all moving parts. Raw gas failures are caused by running these engines without any mix oil. Heat is less of a factor in most 4-Stroke engine failures. This is because 4-Stroke engines have a power stroke every other revolution of the crankshaft compared to a 2-Stroke engine with a power stroke every crankshaft revolution. Raw gas can cause mix lubricated 4-Stroke engine failures from either piston & cylinder scoring or damaged valve train components.



MIX LUBRICATED 4-STROKE RAW GAS SYMPTOMS

Cam Lobe Damage

Pushrod Engines – Nylon cam lobes remain slick with the slightest amount of residual lubrication. Mix lubricated 4-Stroke pushrod engine cams are rarely damaged by running the engine on raw gas. When raw gas does damage a nylon cam, usually both the inner and outer portion of the lobe will melt. Melting can be caused by raw gas washing all lubrication off the cam.

Raw gas may also restrict valve stem movement in the valve guides causing the sticky valves to overload and melt the cam lobe.

Overhead Cam Engines – Mix lubricated 4-Stroke overhead cam engines are large displacement backpack blower engines. These engines have larger valve springs that apply heavier rocker arm pressure to metal cam lobes. Running overhead cam engines on raw gas can cause metal rocker arms to quickly wear metal cam lobes. Raw gas metal cam lobe wear will have a rough scratchy appearance. Metal filings from the worn cam will coat the inside of the valve rocker cover.

Lubrication In Crankcase & Rocker Cover – Expect to find some lubrication inside the crankcase of a mix lubricated 4-Stroke engine run on raw gas. These engines usually don't run hot enough to cook out all oil.

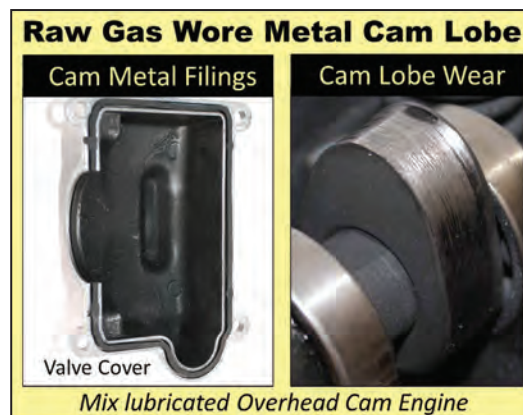

Piston & Cylinder Scoring

Minimal Piston Damage Likely – Mix lubricated 4-Stroke engines inherently run cooler than 2-Stroke engines. Mix lubricated 4-Stroke engines may run a very long time on raw gas before there is any damage to the piston and cylinder, especially with light engine loads. When scoring does occur, it may be minimal.

Heavy Piston Scoring Possible – Heavy wrap around piston and cylinder scoring is possible, depending how long the engine runs on raw gas. Engines with high constant loads, like blowers, are most vulnerable to heavy raw gas scoring.



Stuck Piston Rings – Raw gas failures will cause piston rings to stick in ring grooves wherever heavy scoring occurs.

MIX LUBRICATED 4-STROKE RAW GAS REVIEW

Mix lubricated 4-Stroke engines inherently run cooler than 2-Stroke engines. Residual lubrication will remain in the cooler crankcases and valve covers of most mix lubricated 4-Stroke engine raw gas failures. Raw gas rarely damages nylon cams on pushrod engines but raw gas can quickly wear metal cam lobes on overhead cam engines. Mix lubricated 4-Stroke engine raw gas failures may cause scoring all around the piston. The severity of the scoring depends on engine load and how long the engine runs on raw gas.

MIX LUBRICATED 4-STROKE STALE FUEL FAILURE CAUSE

Stale fuel mix lubricated 4-Stroke engine failures are caused by running engines on old decomposing fuel. It's possible for sticky stale fuel varnish deposits to coat most of the interior of a mix lubricated 4-Stroke engine. The severity of the deposits depends on how stale the fuel is and how long the engine runs on the stuff. The detailed cause of stale fuel failures and preventing these failures are exactly the same as 2-Stroke engine stale fuel failures.

MIX LUBRICATED 4-STROKE STALE FUEL SYMPTOMS

Crankcase Varnish Deposits



Key factor identifying stale fuel failures

Crankcase Varnish Deposits – Like 2-Stroke engines, all of the air/fuel/oil mixture enters the crankcase of mix lubricated 4-Stroke engines first. Some non-volatile components of the mixture, including varnish deposits, are left behind inside the crankcase. Crankcase deposits are a key factor in identifying stale fuel failures. Most other failures will not form deposits in the cooler crankcase.

Valve Train Varnish Deposits

– The air/fuel/oil mixture moves from the crankcase and circulates around all valve train components

on the way to the intake valve. If the fuel is very stale, the mixture may leave varnish deposits on cams, cam followers, pushrods and rocker arms. Most other failures will not form deposits on valve train components.

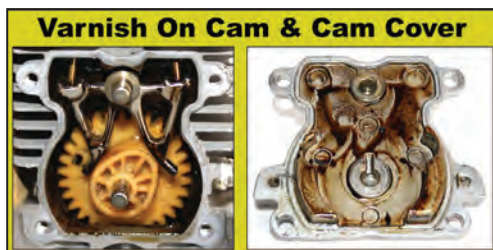

Varnish On Cam & Cam Cover

Varnish Deposits On Valve Stems



Intake & Exhaust Valve Varnish Deposits – Stale fuel varnish builds deposits on both intake and exhaust valve stems of mix lubricated 4-Stroke engines. Valve stem varnish deposits are usually worse on the intake valve stem where stale fuel enters the combustion chamber. Most other engine problems will build more deposits on the hotter exhaust valve stem. If the operator is lucky, stem deposits may stick a valve open causing the engine to quit running before more damage occurs.

Piston Varnish Deposits – Stale fuel varnish deposits will quickly begin to bake all around the piston skirt and eventually coat the entire piston. If the engine continues to run with stale fuel, varnish deposits may cause the piston to stick to the cylinder, locking up the engine.

Stuck Piston Rings – It usually doesn't take long for heavy stale fuel varnish to fill ring grooves and stick piston rings all the way around.

Piston Skirt Varnish & Stuck Piston Rings



MIX LUBRICATED 4-STROKE STALE FUEL REVIEW

Mix lubricated 4-Stroke engines that run on stale fuel can coat almost all internal engine parts with sticky varnish deposits. It's rare for any other engine failures to form deposits in the cooler crankcase or on valve train components. Stale fuel forms varnish deposits on both intake and exhaust valve stems. The engine may quit running if stem deposits stick a valve open. Stale fuel forms varnish deposits on piston skirts and inside ring grooves, usually causing rings to stick. The engine may lock up if varnish deposits build up to the point the piston sticks in the cylinder.

MIX LUBRICATED 4-STROKE VALVE TRAIN FAILURE SYMPTOMS

Shindaiwa mix lubricated 4-Stroke engines have a very sound valve train design. When valve train failures do occur, most can be attributed to a lack of maintenance, excessive valve clearance or heavy valve deposits. Valve clearances should be checked every 135 running hours. Heavy valve deposits are most often caused by dirt ingestion, too much oil in the gas, uncertified oil or stale fuel.

VALVE TRAIN FAILURE SYMPTOMS

Low Engine Compression – Valve train failures often result in low engine compression readings. The location of the combustion leakage can be verified by a cylinder leak down test.

Valve Component Breakage

Excessive Valve Clearance – Mix lubricated 4-Stroke engines with proper valve clearance causes cam lobes to push valves open. Excessive valve clearance causes cam action to pound valves open. The constant pounding of valves at high engine speeds of up to 10,000 rpm, puts tremendous stress on all valve train components. Running mix lubricated 4-Stroke engines for many hours with excessive valve clearance can cause broken valves, broken cam followers and damage to other valve train components.

Dirt Ingestion – Premature excessive valve clearance is usually caused by dirt ingestion wearing cam lobes and cam followers. Whenever valve train component breakage occurs, look for dirt in the air filter housing, dirt carbon in the combustion chamber and valve train component wear.

Routine Valve Adjustments – Over time, some wear of valve train components is normal. Routine valve adjustments at recommended 135 hour intervals will correct for normal wear. Valve component breakage on high hour mix lubricated 4-Stroke engines is usually caused by a lack of regular valve adjustments or no valve adjustments.

Melted Nylon Came Lobes– Heavy valve stem deposits can cause melting of nylon cam lobes on mix lubricated 4-Stroke pushrod engines. When stem deposits build up to the point that valve movement is restricted in the valve guide, it increases load on the valve train. Metal cam follower pressure can increase to the point that the nylon lobe melts. Stem deposits are most likely to build on the hotter exhaust valve, resulting in damage to only the outside exhaust portion of the lobe. The inner intake portion of the cam lobe usually remains unaffected.

Cause Of Valve Deposits – Major causes of valve deposits include dirt ingestion, too much oil in the fuel, rich carburetor adjustments and stale fuel. Uncertified 2-Stroke oil can cause excessive valve deposits as well.

Prevention Of Valve Deposits – Try to verify the operator is using approved ISO L-EGD and JASO FD certified 2-Stroke oil. Red Armor 2-Stroke oil is highly recommended as a way to protect against valve and combustion carbon build up.

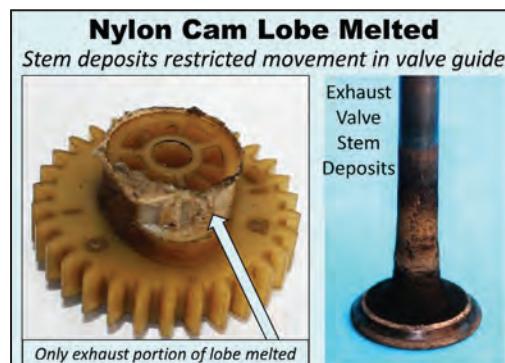
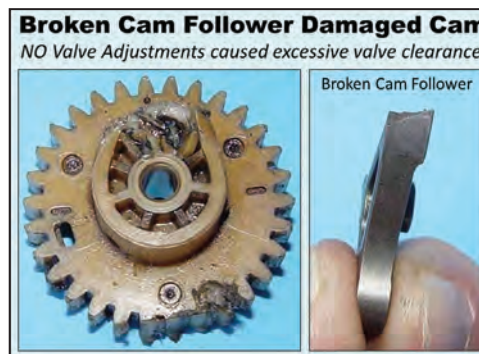

Mix Lubricated 4-STROKE VALVE TRAIN FAILURE REVIEW

Mix lubricated 4-Stroke engine valve component breakage is usually caused by excessive valve clearance. Most often, excessive clearance is from premature wear of cam lobes & cam followers caused by dirt ingestion. Over time, normal wear can cause excessive valve clearance if valves are not adjusted at recommended intervals. Heavy exhaust valve deposits on pushrod engines can cause the outside portion of the nylon cam lobe to melt.



Engine **FAILURE** Analysis Booklet

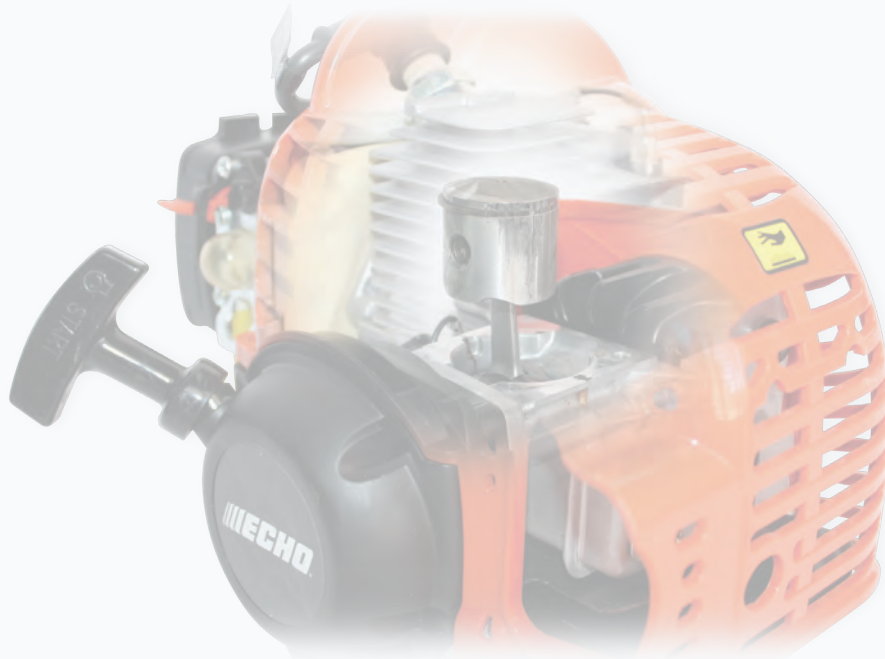

The content of this booklet is the intellectual property of ECHO Incorporated and may not be reproduced in any manner without the written permission of ECHO Incorporated.

© **2013 ECHO Incorporated** – 400 Oakwood Road. Lake Zurich, IL 60047-1564
Website: www.echo-usa.com • Telephone: 847.540.8400

Part Number 99922201930