

# HUSQVARNA

# 185 CD

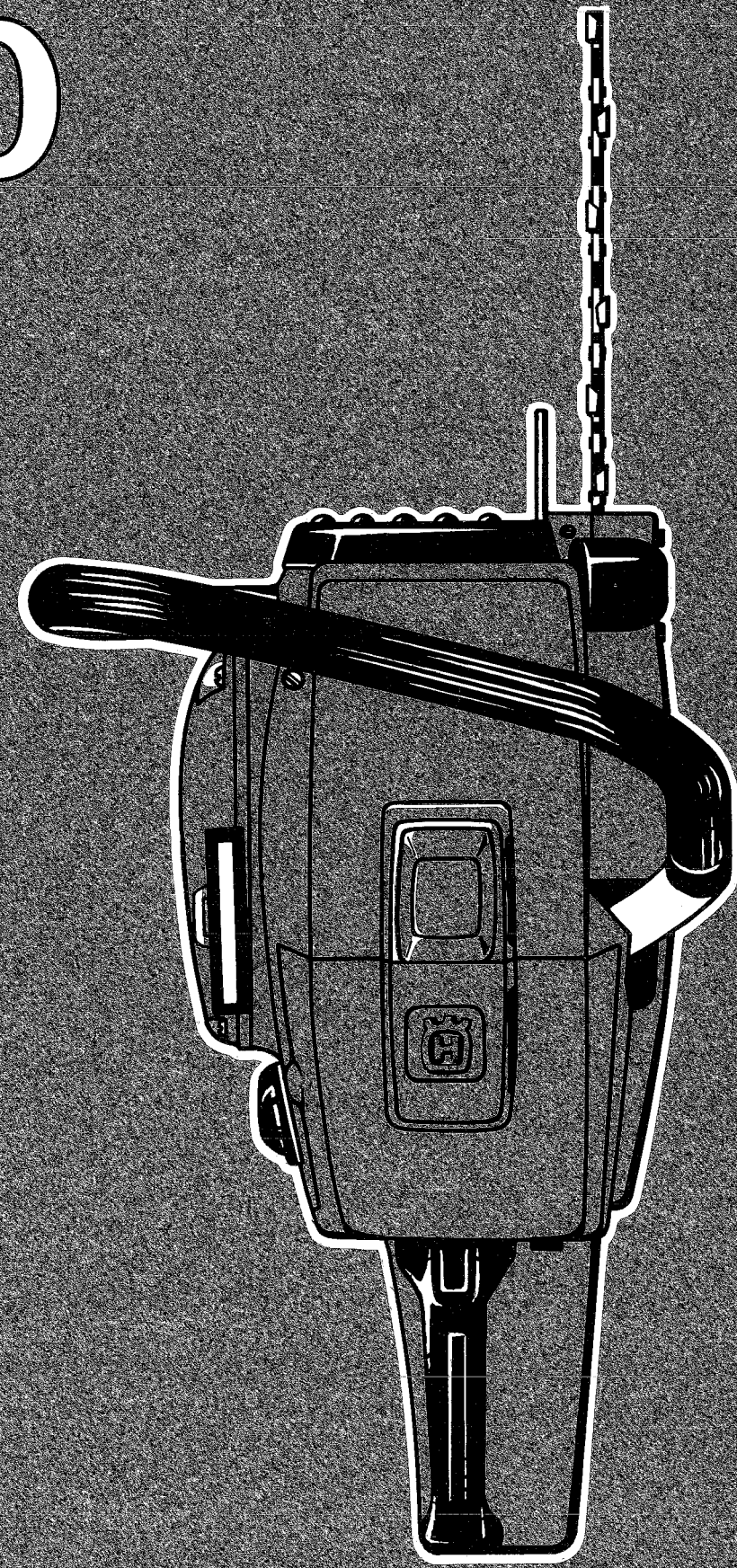

OWNER'S MANUAL

**OWNER'S MANUAL  
HUSQVARNA CHAIN SAW**

**MODEL 185 CD**

**CONTENTS**

<b>1. What is what on the chain saw?</b> .....	2
<b>2. Technical specification</b> .....	3
<b>3. Assembling the guide bar and chain</b> .....	4
<b>4. Fuel and chain oil</b> .....	5
<b>5. Adjusting the oil pump capacity</b> .....	6
<b>6. Starting the chain saw</b> .....	7
Cold engine .....	7
Warm engine .....	8
<b>7. Running in the chain saw</b> .....	9
<b>8. Maintenance</b> .....	9
<b>9. Maintenance schedule</b> .....	10
Daily maintenance .....	10
Weekly maintenance .....	10
Monthly maintenance .....	10
<b>10. Maintenance on certain components</b> .....	11
Adjusting the carburettor .....	11
Cleaning the air filter .....	12
Lubricating the clutch drum bearing .....	13
<b>11. Smaller repairs</b> .....	13
Changing the drive sprocket .....	13
Changing the starter cord and return spring .....	14

# 1. WHAT IS WHAT ON THE CHAIN SAW?

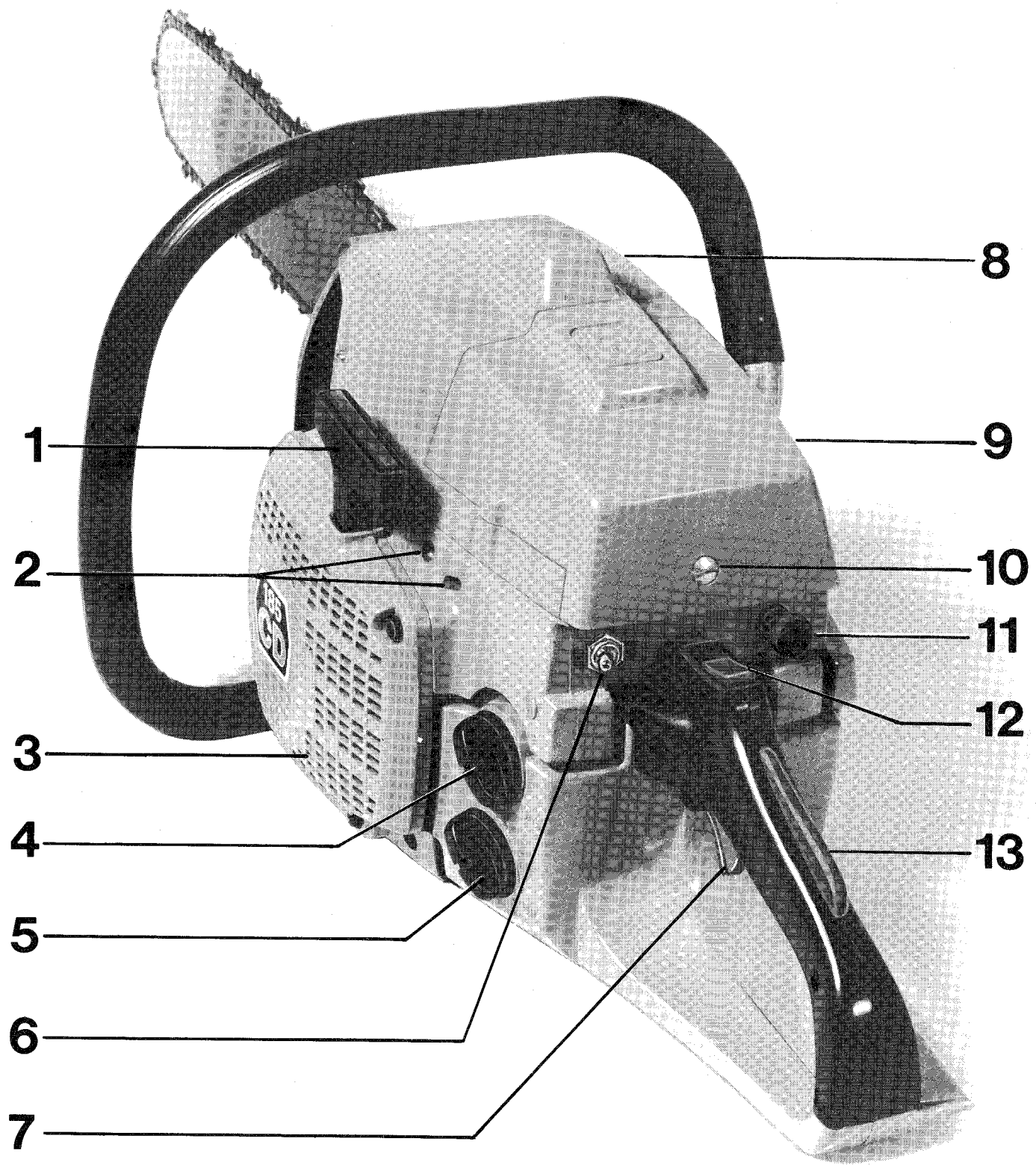

- |                                 |                                     |
|---------------------------------|-------------------------------------|
| 1. Starter handle               | 8. Cylinder cover                   |
| 2. Carburetor adjustment screws | 9. Carburetor cover                 |
| 3. Starter                      | 10. Locking screw, carburetor cover |
| 4. Fuel filler cap              | 11. Choke control                   |
| 5. Oil filler cap               | 12. Starting throttle ratchet       |
| 6. Stop contact                 | 13. Throttle safety catch           |
| 7. Throttle lever               |                                     |

## 2. TECHNICAL SPECIFICATION

### HUSQVARNA CHAIN SAW MODEL 185 CD

#### ENGINE

Displacement .....	85 cm <sup>3</sup>
Bore .....	52 mm
Stroke .....	40 mm
Power output .....	4 kW (5.4 hp)
Engine speed at max. power output .....	8500 rpm

#### IGNITION SYSTEM

Type and make .....	Flywheel, condenser discharge. SEM CD type G6/35
Ignition advance at 8000 rpm .....	24° before t.d.c.
Sparking plug .....	Champion CJ 6 (CJ 7 Y)
Electrode gap .....	0.5 mm

#### FUEL- AND LUBRICATING SYSTEM

Carburettor type .....	Tillotson HS 136 C with speed governor
Fuel tank capacity .....	0.8 litre
Fuel mixture .....	4% oil in regular petrol (1:25)
Oil tank capacity .....	0.5 litre
Chain lubrication .....	Automatic, adjustable for two different oil supplies

#### STANDARD EQUIPMENT

Sawing chain .....	3/8" pitch, thickness of driving links 1.5 mm (0.06")
Guide bar .....	22" homogeneous

#### WEIGHT

Weight empty, incl. chain and 22" hom. guide bar .....	9.78 kg (21.5 lb)
---	-------------------

### 3 ASSEMBLING THE GUIDE BAR AND CHAIN

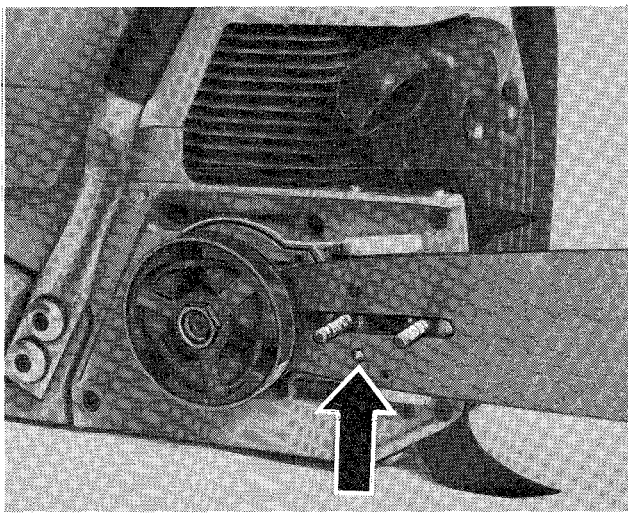

- A. Unscrew the two guide bar nuts and remove the clutch cover and transport packing piece.
- B. Place the guide bar into its rearmost position. Make sure that the chain tensioning stud fits properly into the hole in the guide bar.

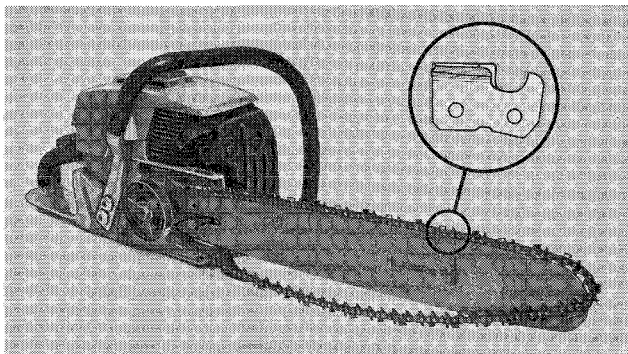

- C. Fit the chain around the drive sprocket and in the groove of the bar. Start on the upper side of the guide bar.

Make sure that the cutting edges of the sawing teeth along the top of the guide bar are facing towards the nose. Also check that the drive links go down properly into the drive sprocket.

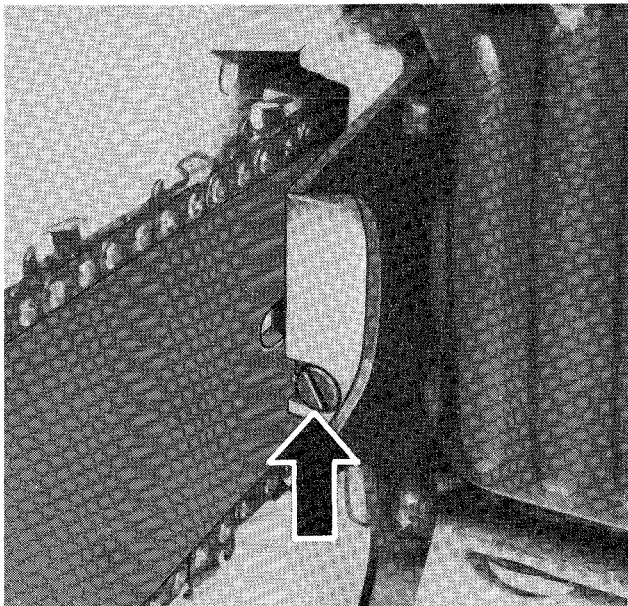

- D. Tension the chain so it does not sag along the bottom of the guide bar.

Check that the chain and guide bar fit properly. Fit the clutch cover and tighten the nuts fingertight only.

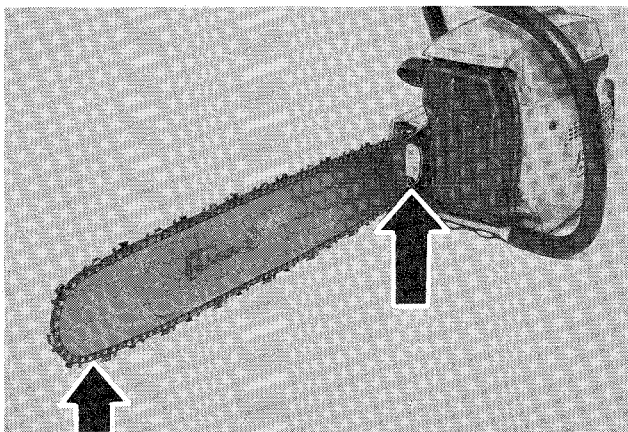

- E. Tension the chain while holding up the guide bar nose. Do not tension the chain stronger than it can be pulled around by hand.

Tighten the guide bar nuts.

**NOTE:**

Do not forget to "run in" the chain and guide bar. Please see the chain manufacturer's recommendation.

**CHECK THE CHAIN TENSION FREQUENTLY FOR BEST PERFORMANCE AND DURABILITY**

## 4. FUEL AND CHAIN OIL

This chain saw is powered by a two-stroke engine, and should be run on a petrol and oil mixture.

Only use a two-stroke oil of highest quality.

The petrol mixture should be 1 part oil to 25 parts petrol. This is 4% oil.

### NOTE:

If self-mixing oil is used, mix 1 part oil with 20 parts petrol. This is 5% oil.

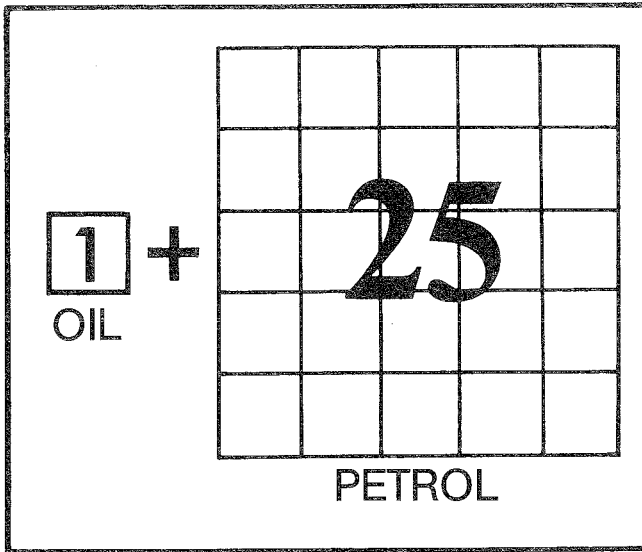

Mixing table		4 %			5 %		
Litres of oil	Pints of oil	Litres of petrol	Petrol in Imp. gallon	Petrol in US gallon	Litres of petrol	Petrol in Imp. gallon	Petrol in US gallon
0,2	0,35	5	1,1	1,3	4	0,8	1,0
0,4	0,70	10	2,2	2,6	8	1,7	2,1
1,0	1,76	25	5,5	6,6	20	4,4	5,2

No extra oil is needed during the running-in period of the engine.

For lubricating the chain and guide bar we recommend a chain lubricating oil with good adhesive properties.

During the wintertime at air temperatures below 0°C (32°F) some types of chain lubricating oils are viscous. This can cause overloading of the oil pump, which can result in damage of the pump drive and pump parts. During cold weather conditions it is therefore necessary to use a "wintergrade" oil which stays fluent even when cold. Concerning the choice of oil and its suitability at different air temperatures, please refer to your Husqvarna dealer.

### NOTE:

On no account waste oil should be used as this can damage the oil pump.

ALWAYS TOP UP WITH FUEL AND CHAIN LUBRICANT AT THE SAME TIME

## 5. ADJUSTING THE OIL PUMP CAPACITY

When using a long guide bar the amount of chain lubricant supplied must be greater than when a short guide bar is used.

This chain saw is equipped with an adjustable oil pump.

When the chain saw is provided with a guide bar longer than 18 inches, we recommend to adjust the oil pump for maximum capacity.

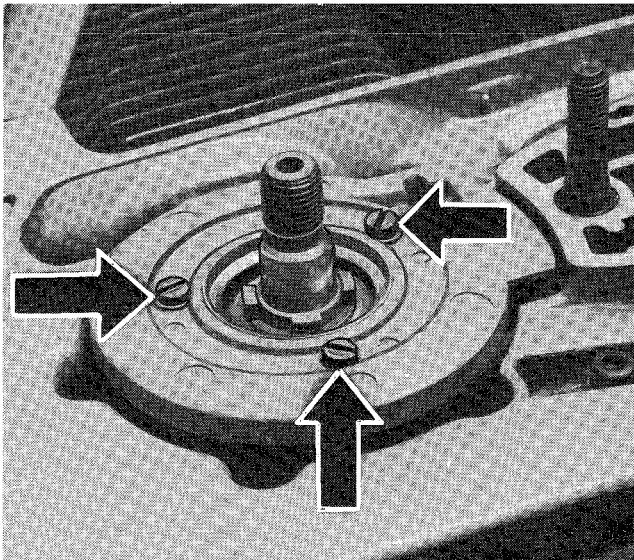

The pump must be removed from the crankcase to be accessible for adjustment.

Remove clutch cover, chain and guide bar, centrifugal clutch and clutch drum.

Unscrew the three slotted screws and remove the pump. On the back side of the pump housing the adjustment screws are accessible.

When delivered from the factory the pump is adjusted for maximum oil supply, i.e. the spigot screw is placed in hole II.

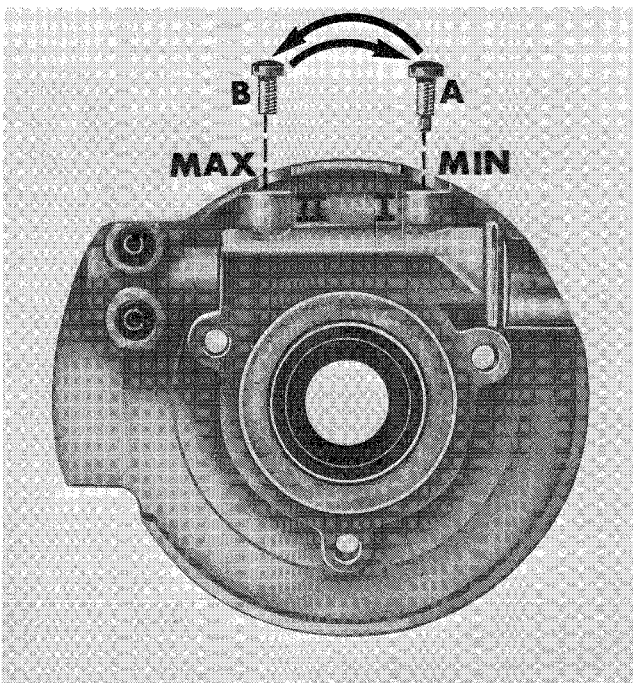

Adjustment is done by changing over the two screws A and B.

By placing the spigot screw (A) in hole II the pump supplies maximum of oil.

By placing the spigot screw (A) in hole I it supplies less oil.

Screw (B) only serves as a sealing screw.

### **Pump capacity**

Maximum: 24–27 cm<sup>3</sup>/min at 6000 rpm

Minimum: 18–21 cm<sup>3</sup>/min at 6000 rpm

## 6. STARTING THE CHAIN SAW

### A. Cold engine

1. Switch on the ignition.
2. Pull out the choke control.

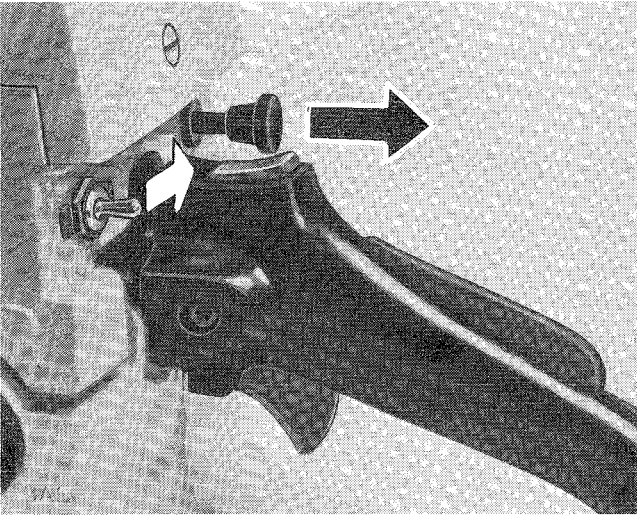

3. Push down the starting throttle ratchet.

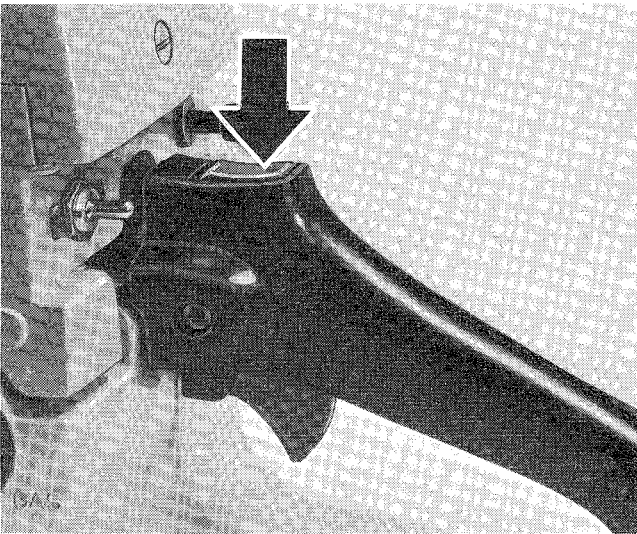

4. Open the throttle fully.
5. Release the throttle control, still with the throttle ratchet pressed down.
6. Now the throttle is in correct starting position.

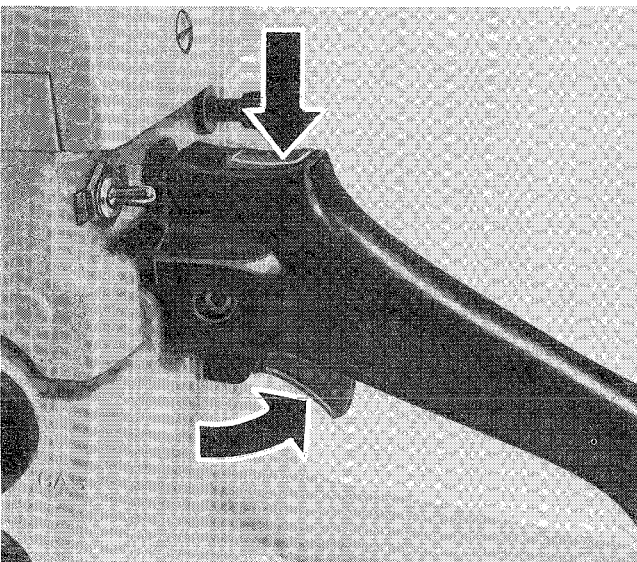



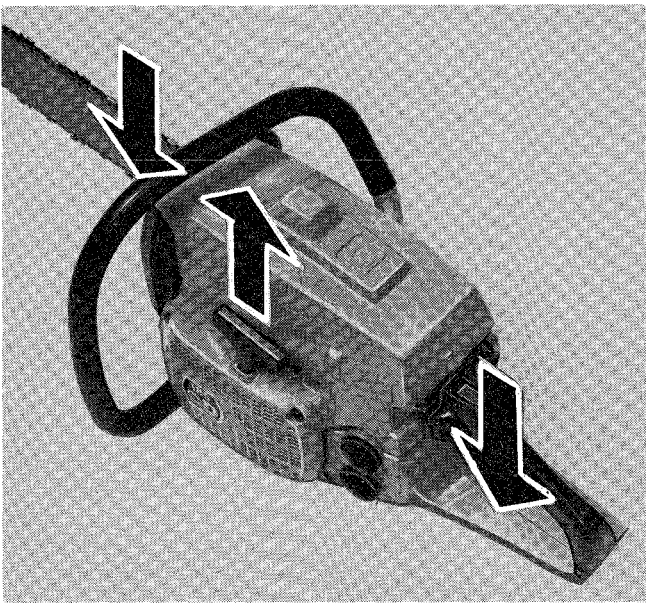

7. Place your right foot on the plate under the rear handle.
8. Grasp the front handle with your left hand and press the saw firmly against the ground. Make sure that the sawing chain is not in contact with brushwood or the like.
9. Grasp the starting handle with your right hand and pull out the starting cord slowly until the starting pawls engage. Then pull the starting handle sharply.

**NOTE:**

Do not pull the cord right out or release the starting handle in the pulled out position as this can cause damage when the handle flies back.

10. Normally the engine will start after 2-3 starting attempts. Then push in the choke control. Pull up the throttle control to full throttle position and the catch disengages.

## **B. Warm engine**

Use the same starting procedure as for cold engine but do not pull out the choke control.

**NOTE:**

One of the most common causes of difficulty in starting is that too many attempts are made with closed choke flap resulting in a "flooded" engine. If so, remove and check the sparking plug. If it is wet, wipe it dry.

Make new starting attempts with the dry sparking plug fitted and with fully open choke flap as well as full throttle.

## **7. RUNNING-IN THE ENGINE**

Although the chain saw is partially run-in as supplied from the factory, it is advisable to begin using a brand new chain saw on small-dimension timber. Avoid sawing with the engine under full load for more than approximately half a minute at a time during the first two days. This will ensure that all

bearings are well bedded-in and acquire a hard and durable surface. The piston rings will get a smooth surface against the cylinder wall and this one will also get a proper oil film for lowest friction and highest tightness.

During the running-in period no extra oil in the petrol is needed.

## **8. MAINTENANCE**

To give of its best, a chain saw must be properly looked after. The service measures described in the following are of a preventive nature designed to obviate costly repairs which may be necessary if maintenance is neglected.

For best performance and longest engine life it is advisable to bring the chain saw to an authorized dealer after approx. every 250 working hours every second month for a complete workshop overhaul.

## 9. MAINTENANCE SCHEDULE

### Daily maintenance

1. Clean the saw body.
2. Clean the air filter. Change if necessary.
3. Turn around the guide bar and clean its groove.
4. Clean the fan and air intake in the starting device.
5. Clean the cooling fins on the cylinder.
6. Clean the space under the clutch cover.
7. Sharpen the chain and check its tension.
8. Check the oiling system for the chain.

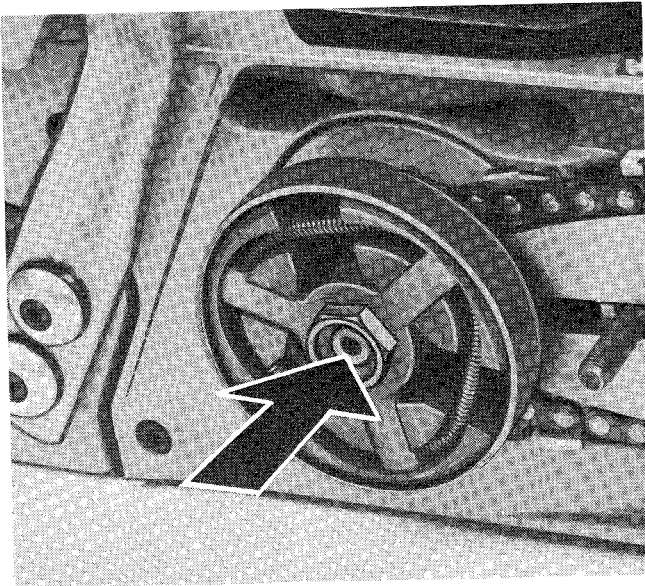
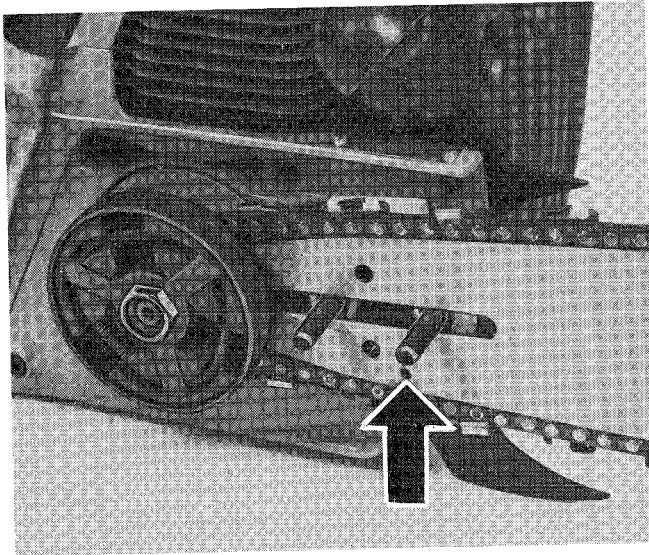
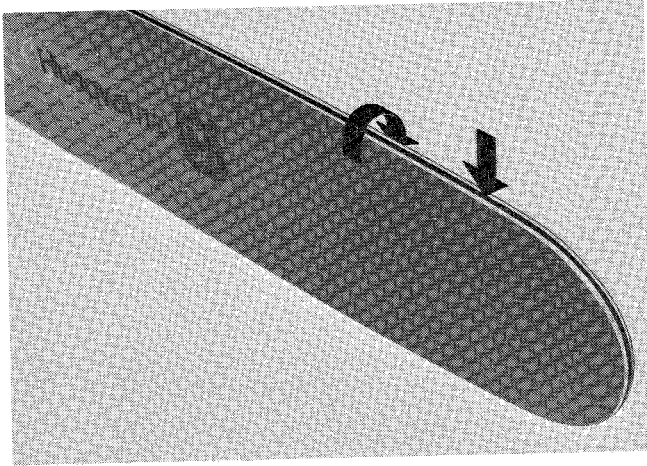

### Weekly maintenance

1. Check the starting device, its cord and return spring.
2. Clean the outside of the sparking plug and check the gap. Adjust or change the plug if necessary.
3. File the sides of the guide bar.
4. Lubricate the bearing for the centrifugal clutch.

### Monthly maintenance

1. Wash out the fuel tank with petrol.
2. Wash out the oil tank with petrol.
3. Clean the carburettor.
4. Clean the ignition system.

## 10. MAINTENANCE ON CERTAIN COMPONENTS

### Adjusting the carburettor

The carburettor has three adjusting screws:

L = Low speed needle

H = High speed needle

T = Throttle adjusting screw

The adjustment should preferably be carried out by a trained mechanic. The engine shall be warm during this adjustment.

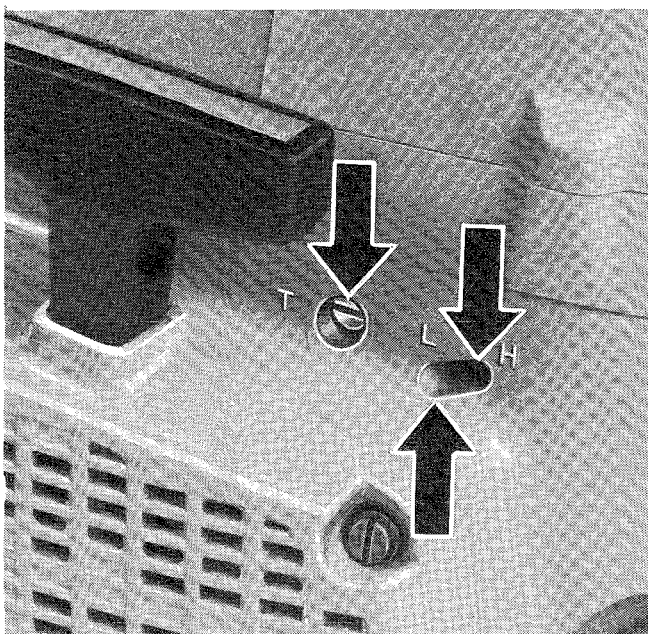

Screw the needles H and L right in with a small screwdriver. Do not screw them down too hard as this can damage the carburettor housing.

From this position screw the

L needle out 1,1 turn

H needle out 0,9 turn

The throttle screw T should be adjusted as necessary, i.e. when the idling speed of the engine is too high or too low.

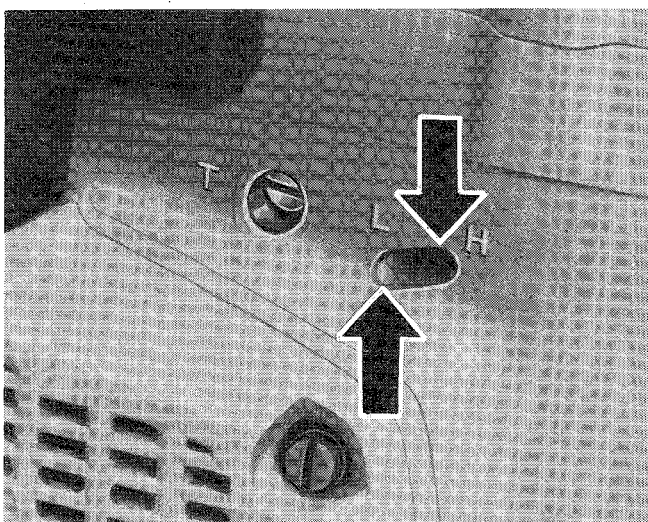

Set the throttle screw (T) to give a good margin between idling speed and clutch engagement speed.

Idling speed should be approx. 2500 rpm.

#### NOTE:

All carburettor adjustments should be carried out with a warm engine and clean air filter.

#### CAUTION

For longest service life and maximum power it is most important to ensure that the carburettor is correctly tuned. The high speed needle (H) must be adjusted so that maximum power is obtained, not maximum revs. Overrevving reduces engine power and shortens engine life.

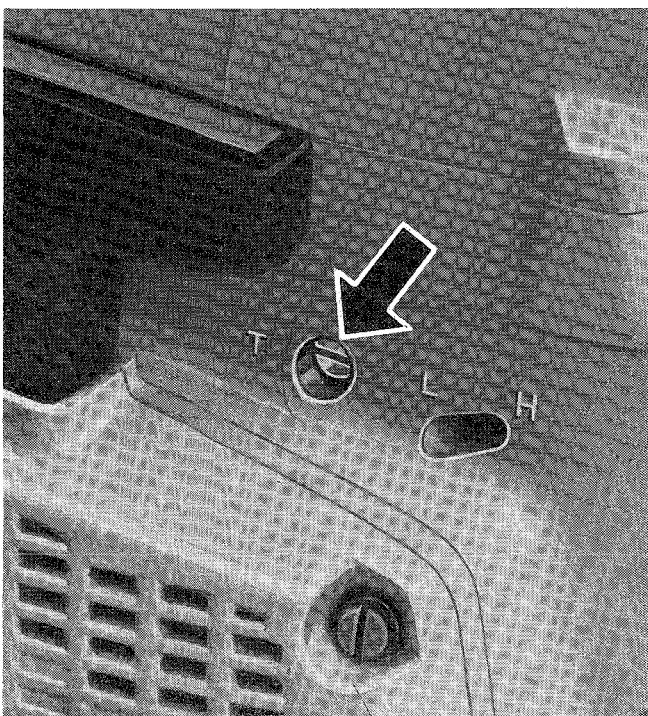

## Cleaning the air filter

Remove the carburettor cover after turning the screw a quarter of a turn.

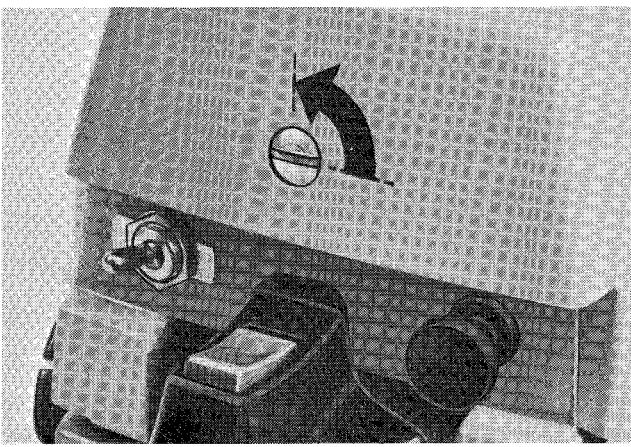

Back off the two screws holding the air filter and lift it out.

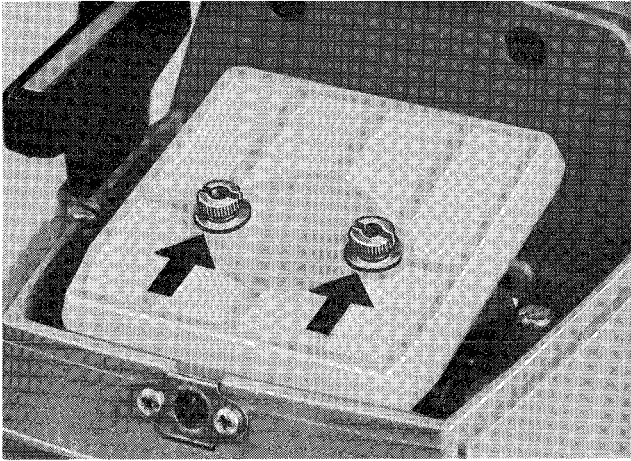

Separate the two halves of the air filter with a screwdriver inserted between the two nob.

Clean the filter in chain saw fuel or paraffin etc.

Before assembling the filter in reverse order make sure that it is quite clean from dirt. A good idea is to have two air filters which can be used in alternate order.

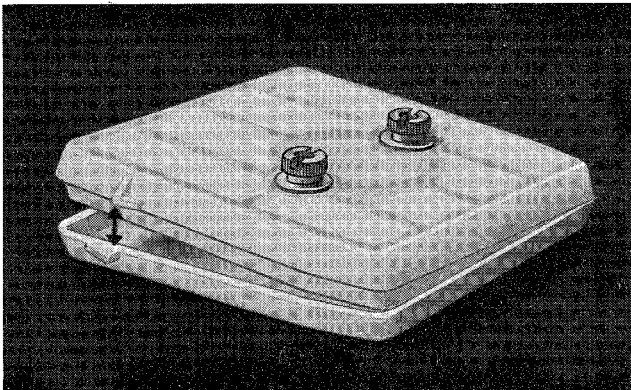

When assembling the carburettor cover the groove in the retaining screw shall be in horizontal position. Then just push on the screw to lock the cover in correct position.

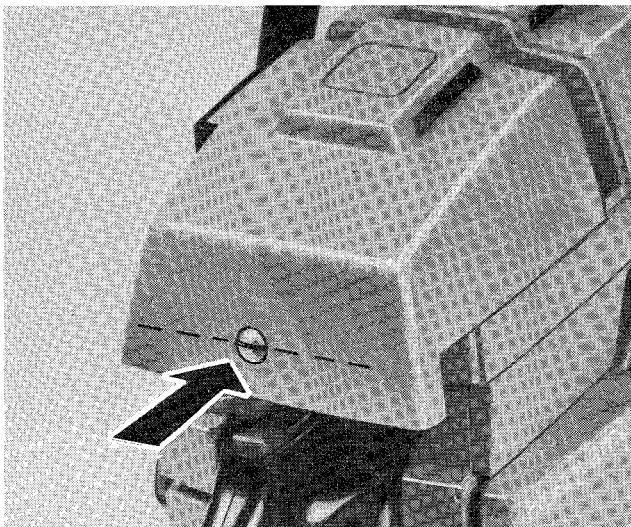

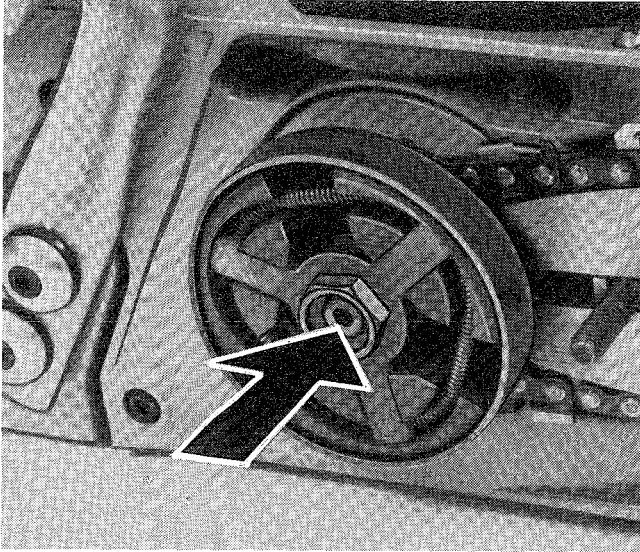

## Lubricating the clutch drum bearing

Remove the clutch cover. Inject ball bearing grease with the grease gun in the centre of the crankshaft. Two strokes of the grease gun will be sufficient.

**NOTE:**

Make sure that grease really emerges from the gun when it is pumped.

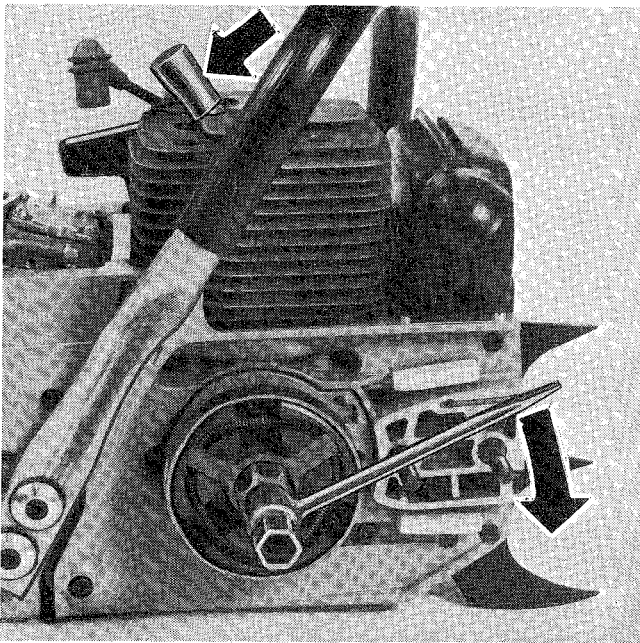

## 11. SMALLER REPAIRS

### Changing the drive sprocket

Remove the clutch cover, chain, guide bar and cylinder cover. Replace the sparking plug with the piston stop tool (part No. 51 20 238-01).

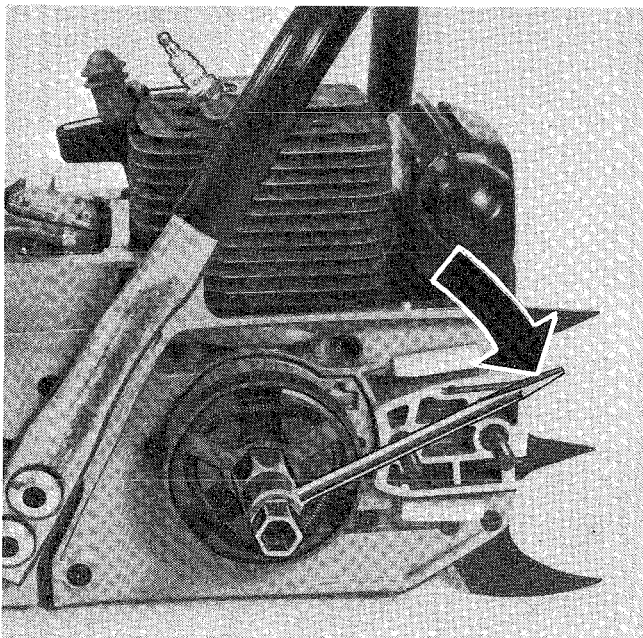

If a piston stop is not available the centrifugal clutch can be removed by doing as follows:

Disconnect the ignition cable from the sparking plug. Fit a socket spanner on the clutch nut and turn until compression resistance is felt. Strike the handle of the spanner smartly – mind the saw body!

**NOTE:**

The clutch nut has a left-hand thread and consequently unscrews clock wise.

Remove the clutch and drum.

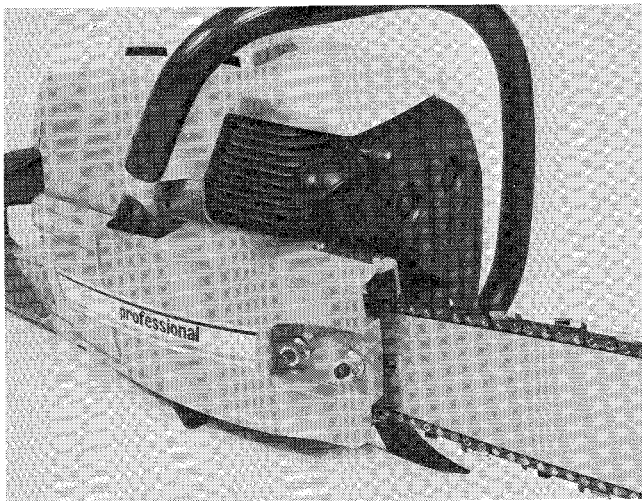

Fit the drive sprocket on the crankshaft. Screw the clutch onto the shaft (anti-clockwise) finger-tight only. When the saw is subsequently started the clutch will be automatically tightened.

**NOTE:**

Fit the guide bar and chain before starting the engine. Lubricate the clutch bearing.

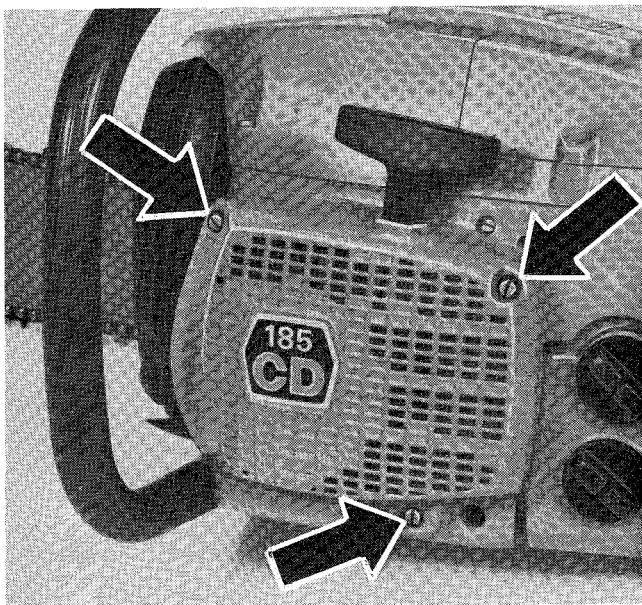

## Changing the starter cord and return spring

Remove the three starter retaining screws and lift the starting device and distance piece off the chain saw.

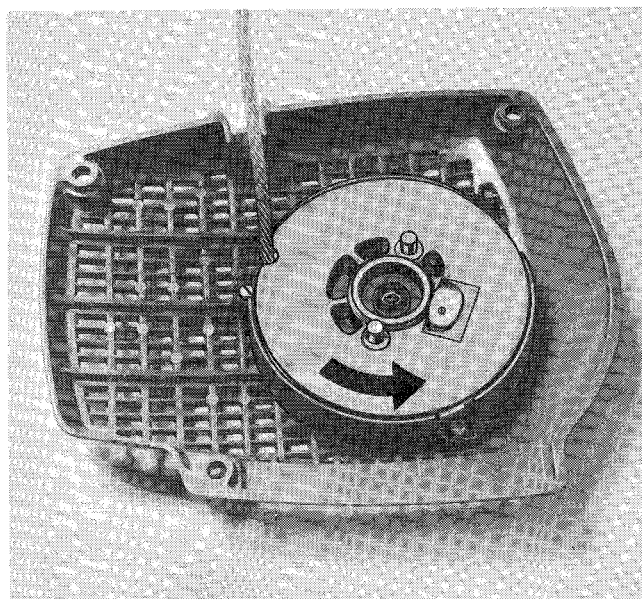

## Dismantling

Pull out the starting cord to some extent and lift it up into the notch on the pulley.

Zero-set the return spring by carefully permitting the pulley to rotate backwards under spring pressure.

Remove the screw and washer in the centre of the pulley and lift this one off.

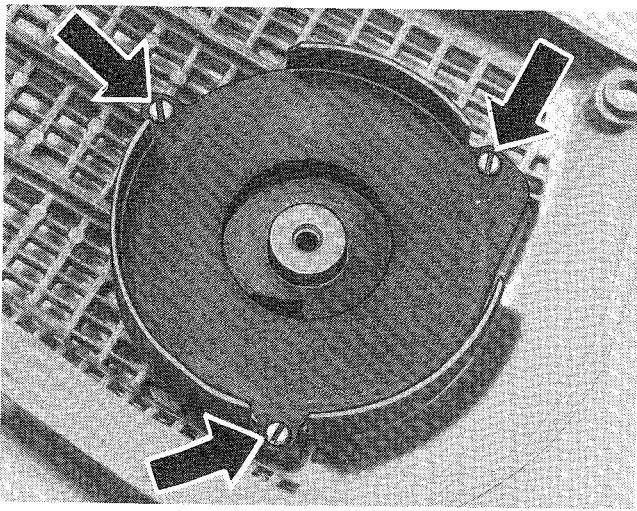

Remove the three screws holding the protection plate and lift this one off. Replace the return spring if necessary. Lubricate with motor oil only. Place the covering plate and fasten the three screws.

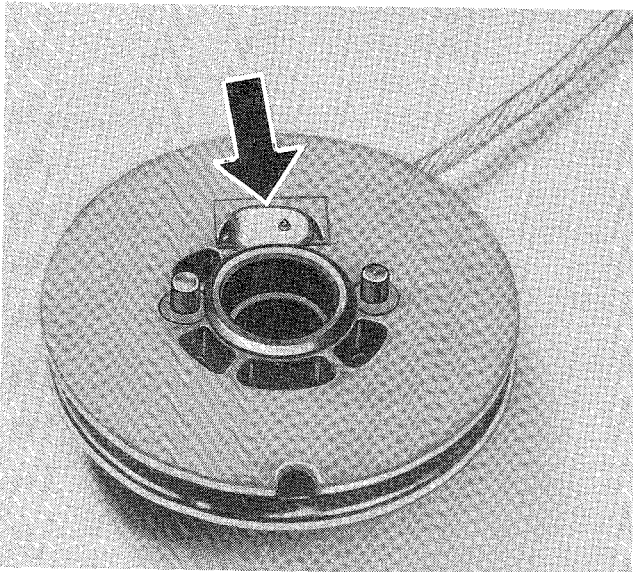

## Assembling

Thread the cord into the pulley. Make sure that the stop "cube" has a proper fit in the recess in the pulley and that the screw in the cube has its head facing the pulley (the end of the screw points outwards).

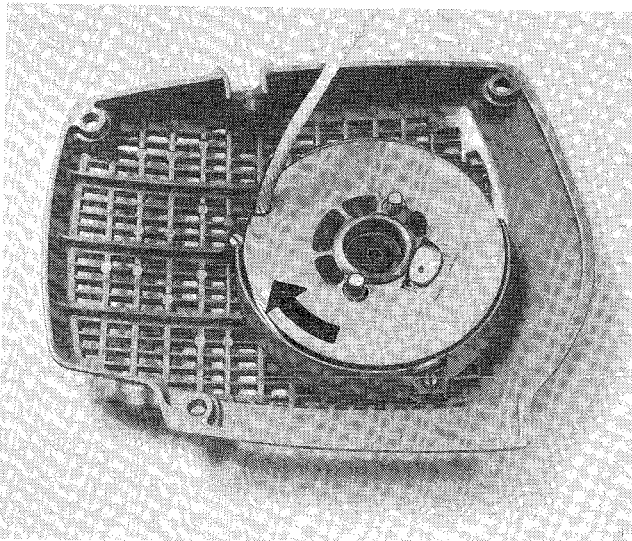

Turn the cord about two turns around the pulley and mount this one in the housing. Place the washer and tighten the screw. Make sure that the pulley can move freely.

Pull out the cord and lift it up into the notch on the pulley. Tension the return spring by turning the pulley clockwise about four turns.

### NOTE:

Make sure that it is possible to turn the pulley at least half a turn further when the cord is fully pulled out.